





Key catalogue for household
and commercial flat, cruciform,
lift and mail box keys

Catalogo chiavi piatte per serrature
a cilindro, chiavi a croce,
chiavi per ascensori e casellari postali

Flach-und Kreuzbartschlüssel,
Fachkasten-und Liftschlüssel Katalog

Catalogue clés plates
pour cylindres, clés cruciformes,
clés pour ascenseurs et casiers

Catálogo llaves planas
para cilindro, llaves en cruz,
llaves para casillas y ascensores

Catálogo das chaves planas
para fechaduras de cilindro, chaves tetra,
chaves para elevadores e caixas de correio



Silca Library	VI
Index	VIII
Key identification	X
Uses	XI
Technical information	XII
Ultralite	XVI
Silky	XVIII
Slim Color	XX
Art keys	XXIV
Serie città	XXVIII
Serie Distinzione heads	XXX

Cylinder lock keys	1
Dimple keys	203
Cruciform keys	225
Mail box and lift keys	241
General index	249
Dimple keys index	289
Cruciform keys index	293
Mail box and lift keys index	297



Libreria Silca	VI
Terminologia	VIII
Identificazione chiave	X
Utilizzi	XI
Informazioni tecniche	XII
Ultralite	XVI
Silky	XVIII
Slim Color	XX
Art keys	XXIV
Serie città	XXVIII
Teste Serie Distinzione	XXX

Chiavi piatte per serrature a cilindro	1
Chiavi punzionate	203
Chiavi a croce	225
Chiavi per casellari e ascensori	241
Indice generale	249
Indice chiavi punzionate	289
Indice chiavi a croce	293
Indice chiavi per casellari e ascensori	297



Datenarchiv Silca	VI
Terminologie	VIII
Schlüsselidentifikation	X
Verwendungen	XI
Technische Auskünfte	XII
Ultralite	XVI
Silky	XVIII
Slim Color	XX
Art keys	XXIV
Serie città	XXVIII
Schlüsselköpfe der Serie "Distinzione"	XXX

Zylinderschlüssel	1
Bohrmuldenschlüssel	203
Kreuzschlüssel	225
Fachkästen-und Liftschlüssel	241
Generalverzeichnis	249
Bohrmuldenschlüssel Index	289
Kreuzschlüssel Index	293
Fachkästen-und Liftschlüssel Index	297



Bibliothèque Silca	VI
Terminologie	VIII
Identification clé	X
Utilisations	XI
Informations techniques	XII
Ultralite	XVI
Silky	XVIII
Slim Color	XX
Art keys	XXIV
Serie città	XXVIII
Têtes série Distinction	XXX

Clés plates pour serrures a cylindre	1
Clés à points	203
Clés cruciformes	225
Clés pour casiers et ascenseurs	241
Index général	249
Index clés à points	289
Index clés cruciformes	293
Index clés pour casiers et ascenseurs	297



Librería Silca	VI
Terminología	VIII
Identificación de la llave	X
Utilizaciones	XI
Informaciones técnicas	XII
Ultralite	XVI
Silky	XVIII
Slim Color	XX
Art keys	XXIV
Serie città	XXVIII
Cabezas Serie Distinzione	XXX

Llaves planas para cerraduras a cilindro	1
Llaves de seguridad	203
Llaves en cruz	225
Llaves para casillas y ascensores	241
Indice general	249
Indice llaves de seguridad	289
Indice llaves en cruz	293
Indice llaves para casillas y ascensores	297



Livraria Silca	VI
Terminologia	VIII
Identificação de uma chave	X
Utilizações	XI
Informações técnicas	XII
Ultralite	XVI
Silky	XVIII
Slim Color	XX
Art keys	XXIV
Serie città	XXVIII
Cabeças Serie Distinzione	XXX

Chaves planas para fechaduras de cilindro	1
Chaves de pontos	203
Chaves tetra	225
Chaves para caixas de correio e elevadores	241
Índice geral	249
Índice chaves de pontos	289
Índice das chaves tetra	293
Índice das chaves para caixas de correio e elevadores	297



Silca is a leader because we do things first. The modern key catalogues were born thanks to Silca.

Silca was the first to provide an easy to consult and precise tool for facilitating works in key copying centres and for specialists: it was finally possible to rapidly and safely identify the correct duplicate, without any margins of error from a wide range of selections.

Since then, every Silca catalogue has been a rational and complete tool: keys are reproduced in their true size and ordered alphabetically according to the lock brand name.

It is sufficient to place the original over the reproduction to identify the correct duplicate key.

The simplest ideas are the most innovative and long-lasting. In fact, still today, the Silca Catalogue is a standard and point of reference for the entire sector.

This new catalogue not only proposes all updated references, but also a new product philosophy that, thanks to the most innovative materials, is certain to greatly improve quality of service, also for less common references, but still present in the Silca range of products.

Contact your Silca Distributor or Silca Customer Service: we are at your complete disposition to provide more detailed information about news and items that you may be interested in.



Silca è leader perché fa le cose per prima. I moderni cataloghi per chiavi sono nati grazie a Silca.

Proprio Silca fornì per prima uno strumento di consultazione facile e preciso per agevolare il lavoro dei centri duplicazione chiavi e degli specialisti: finalmente si poteva individuare con rapidità e sicurezza il duplicato corretto, senza margini di errore e all'interno di una ampia gamma.

Ogni catalogo Silca, da allora, è uno strumento ragionato e completo: le chiavi sono riprodotte in grandezza naturale e ordinate alfabeticamente secondo la marca serratura.

Basta sovrapporre la chiave originale per individuare il duplicato cercato. Le idee semplici sono le più innovative e durature. Infatti, ancor oggi, il Catalogo Silca è uno standard e un punto di riferimento per tutto il settore.

Questo nuovo catalogo propone non solo un aggiornamento di tutte le referenze, ma anche una nuova filosofia di prodotto che, grazie alla ricerca dei materiali più innovativi, è destinata a migliorare di molto la qualità del servizio anche per le referenze meno diffuse ma da sempre presenti nella gamma Silca. Contattate il vostro Distributore Silca o il Customer Service Silca: siamo a completa disposizione per fornire informazioni precise sulle novità introdotte e sugli articoli di vostro interesse.



Silca gehört zu den Marktführern, weil Entwicklungen und Marktveränderungen schnell umgesetzt werden. Der moderne Schlüsselkatalog, so wie wir ihn heute kennen wurde zusammen mit Silca entwickelt.

Silca stellte als eines der ersten Unternehmen einen Katalog zur Verfügung, um die Arbeit von Schlüsselzentralen und Schlüsselfachleuten zu erleichtern. Endlich konnte man schnell und sicher den richtigen Schlüsselrohling in einem breitgefächerten Produktsortiment erkennen und dadurch die Fehlerquote bei der Auswahl des richtigen Schlüssels reduzieren. Seitdem ist jeder Katalog der Firma Silca ein durchdachtes und vollständiges Instrument welches in keinem Fachgeschäft fehlen darf. Die Schlüssel sind in Originalgröße abgebildet und nach Schlossherstellern in alphabetischer Reihenfolge geordnet. Man muss nur den Originalschlüssel darüber legen, um das gewünschte Duplikat zu finden. Die Umsetzung von Ideen hin zu einfachen Lösungen sind Innovationen die lange Bestand haben. Noch immer stellt der Silca Katalog einen Standard und Bezugspunkt für den gesamten Sektor dar. Der neue Katalog bietet nicht nur eine Aktualisierung des gesamten Sortiments, sondern ist auch gleichbedeutend für eine neue Produktphilosophie. Neue, innovative Materialien und Produkte kombiniert mit einem umfangreichen Sortiment an „ungängigen“ Schlüsselprofilen, die von jeher im Silca Sortiment enthalten sind. Wenden Sie sich an Ihren Fachhändler oder an die Silca Vertriebsmitarbeiter. Wir stehen Ihnen gern hilfreich zur Seite, um Ihnen genaue Informationen über unsere Neuheiten und über die Artikel, für die Sie sich interessieren, zur Verfügung zu stellen.



Silca est un leader car l'innovation a toujours été l'une de ses principales priorités. Les catalogues modernes de clés ont vu le jour grâce à Silca.

Silca fournissait alors, pour la première fois, un outil de référence simple et précis permettant de faciliter le travail des points de reproduction de clés et des spécialistes : il était enfin possible de trouver rapidement et de façon sécurisée une ébauche adaptée, sans marge d'erreur et dans un large éventail de produits.

Depuis lors, tous les catalogues Silca sont des outils intelligents et complets : les clés sont représentées en grandeur nature et classées par ordre alphabétique en fonction de la marque de la serrure.

Il suffit simplement de superposer la clé d'origine pour identifier l'ébauche nécessaire.

Les idées simples sont toujours les plus novatrices et durables. En effet, aujourd'hui encore, le catalogue Silca constitue une base et un point de référence pour l'ensemble du secteur.

Ce nouveau catalogue offre non seulement une mise à jour de toutes les références, mais également une nouvelle philosophie de produit qui, avec la recherche de matériaux innovants, vise à améliorer considérablement la qualité du service, même pour les références les moins répandues, mais néanmoins présentes dans la gamme Silca.

Contactez votre revendeur Silca ou le service clientèle Silca : nous sommes toujours disponibles pour vous fournir des informations précises sur les nouveautés proposées et les articles susceptibles de vous intéresser.



Silca es líder porque hace las cosas primero. Los catálogos modernos para llaves han nacido gracias a Silca.

Precisamente, Silca fue la primera empresa que proporcionó una herramienta de consulta precisa y fácil de emplear, con el objetivo de simplificar el trabajo de los centros de duplicación de llaves y de los especialistas: con ella, finalmente fue posible encontrar de forma rápida y segura el duplicado correcto, sin posibilidad de error y dentro de una amplia gama.

Desde entonces, cualquier catálogo Silca ha sido una herramienta meditada y completa: las llaves se reproducen a tamaño natural y se presentan ordenadas alfabéticamente según la marca de la cerradura. Solo hay que sobreponer la llave original para encontrar el duplicado que se está buscando.

Las ideas simples son las más innovadoras y duraderas. En efecto, todavía hoy el Catálogo Silca es un estándar y un punto de referencia para todo el sector.

Este nuevo catálogo propone no solo una actualización de todas las referencias sino también una nueva filosofía de producto que, gracias a la búsqueda de los materiales más innovadores, tiene el fin de mejorar considerablemente la calidad del servicio, también para las referencias menos difundidas, pero presentes desde siempre en la gama Silca.

Contacte con su distribuidor Silca o con el departamento de atención al cliente de Silca: estamos a su completa disposición para facilitarle información precisa sobre las novedades incorporadas y sobre los artículos de su interés.



Silca é líder no setor porque faz as coisas por primeiro. Os modernos catálogos para chaves nasceram graças à Silca.

Foi próprio a Silca a primeira a fornecer um instrumento de consulta fácil e preciso para facilitar o trabalho dos centros de duplicação de chaves e dos especialistas: finalmente é possível identificar com rapidez e segurança a cópia correta, sem margens de erro e dentro de uma vasta gama.

Desde então, cada catálogo Silca, é considerado um instrumento fundamental e completo: as chaves são reproduzidas em tamanho natural e colocadas em ordem alfabética conforme a marca da fechadura.

Basta sobrepor a chave original para localizar a cópia desejada.

As ideias simples são as mais inovadoras e duráveis. Na verdade, até hoje, o Catálogo Silca é um padrão e um ponto de referência para o setor.

Este novo catálogo oferece não só uma atualização de todas as referências, mas também uma nova filosofia de produto que, graças à pesquisa dos materiais mais inovadores, serve para melhorar significativamente a qualidade do serviço inclusive para os produtos menos utilizados, mas sempre presentes na gama de produtos Silca.

Contate o seu Distribuidor Silca ou o Serviço de Atendimento ao Cliente Silca: estamos à sua completa disposição para fornecer informações precisas sobre as novidades apresentadas e sobre os artigos de seu interesse.

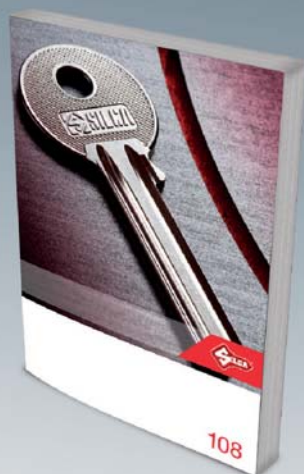

108 CATALOGUE



MONTHLY SILCA NEWS BULLETINS



SILCA LIBRARY

This Catalogue updates and completes information relative to all flat keys for cylinder locks, cruciform keys, lift and mailbox keys produced by Silca. If you would like to keep your catalogues always updated, go to visit www.silca.biz. Every month you can find out what new keys have been produced by consulting and printing the "Silca News Bulletins".

ELECTRONIC KEY CATALOGUE

Silca also makes its electronic key catalogue available to you, which contains all of our paper catalogues. We will update you in real time with all the news, also by smart phone. The Silca electronic catalogue is the ideal assistant for all office activities, the management of stock references, automatic creation of orders, printing packing lists and much more.



LIBRERIA SILCA

Questo catalogo aggiorna e completa le informazioni relative a tutte le chiavi piatte per serrature a cilindro, chiavi a croce, per ascensori e casellari postali prodotte da Silca.

Se desiderate mantenere sempre aggiornati i vostri cataloghi, collegatevi al sito www.silca.biz. Ogni mese saprete quali nuove chiavi sono state prodotte consultando e stampando i bollettini "Silca News".

CATALOGO CHIAVI ELETTRONICO

Silca mette a vostra disposizione il catalogo elettronico che contiene tutti i cataloghi cartacei. Vi aggiorna in tempo reale con tutte le ultime novità anche su smartphone. Il catalogo elettronico Silca è l'assistente ideale per le attività di ufficio, per la gestione delle referenze a stock, per la creazione automatica di ordini, la stampa di bindelli e molto ancora.



DATENARCHIV SILCA

Mit Hilfe dieses Informationswerkzeuges erhalten Sie aktualisierte und vervollständigte Informationen in Bezug auf alle von Silca produzierten Flachschlüssel, Kreuzbartschlüssel, Schlüssel für Aufzüge und Postfächer usw. Damit Ihre Kataloge immer auf dem neuesten Stand sind, können Sie Neuheiten auf der Webseite www.silca.de abrufen. Jeden Monat erfahren Sie, welche neuen Schlüssel produziert werden, wenn Sie den monatlichen Ticker "Silca News" aufrufen und ausdrucken.

ELEKTRONISCHER SCHLÜSELKATALOG

Silca stellt Ihnen einen elektronischen Katalog zur Verfügung, in dem sämtliche gedruckte Kataloge enthalten sind. Sie werden auch über das Smartphone in Echtzeit über alle Neuheiten auf dem Laufenden gehalten. Der elektronische Katalog von Silca ist das ideale Hilfsmittel für die Arbeit im Büro, die Verwaltung des Lagerbestands, die automatische Erstellung von Bestellungen, den Ausdruck von Verpackungslabels und vieles andere mehr.

CATALOGUE CODE 699

To order a copy of this catalogue: code P699
 Per ordinare una copia di questo catalogo: codice P699
 Um eine Kopie von diesem Katalog zu bestellen: Code P699
 Pour commander une copie de ce catalogue: code P699
 Para ordenar una copia de este catálogo: código P699
 Para ordenar uma cópia deste catálogo: código P699

WWW.SILCA.BIZ

To update catalogue 108, visit the website and download the "Silca News Bulletins" newsletters, which are updated monthly.
 Per aggiornare il catalogo 108 consultate il sito e scaricate i bollettini "Silca News" aggiornati mensilmente.
 Um den Katalog 108 zu aktualisieren, rufen Sie unsere Webseite auf und laden Sie die Newsticker "Silca News" herunter, die monatlich auf den neuesten Stand gebracht werden.
 Pour mettre le catalogue 108 à jour, visitez notre site et téléchargez les bulletins « Silca News » mis à jour une fois par mois.
 Para actualizar el catálogo 108, consulte el sitio web y descargue los boletines "Silca News" actualizados mensualmente.
 Para atualizar o catálogo 108 consulte o site e baixe os boletins "Silca News" atualizados mensalmente.



SILCA ELECTRONIC KEY CATALOGUE



SILCA EKC WEB MOBILE



BIBLIOTHÈQUE SILCA

Ce catalogue actualise et complète les informations fournies sur toutes les clés plates pour cylindres, les clés cruciformes, les clés pour ascenseurs ouboîtes postales produites par Silca.

Si vous souhaitez que vos catalogues soient toujours à jour, visitez notre site Internet www.silca.biz. Tous les mois, vous serez informés sur les nouvelles clés produites en consultant et en imprimant les bulletins «SILCA News».

CATALOGUE DE CLÉS ÉLECTRONIQUES

Silca met à votre disposition un catalogue électronique contenant l'ensemble de nos catalogues d'ébauches. Il est actualisé en temps réel avec toutes les dernières nouveautés, y compris pour la version destinée aux Smartphones. Le catalogue électronique Silca est l'assistant idéal des activités administratives comme la gestion des références en stock, mais également pour la création automatique des commandes, l'impression des news et bien plus encore.



LIBRERÍA SILCA

Este catálogo actualiza y completa la información relativa a todas las llaves planas para cerraduras de cilindro, llaves de cruz y llaves para ascensores y buzones fabricadas por Silca.

Si desea que sus catálogos siempre estén actualizados, conéctese al sitio www.silca.biz. Cada mes le será posible conocer qué llaves nuevas se han fabricado consultando e imprimiendo los boletines "Silca News".

CATÁLOGO DE LLAVES ELECTRÓNICO

Silca pone a su disposición un catálogo electrónico que recopila todos los catálogos impresos. Además, mediante su smartphone le mantiene informado, en tiempo real, sobre todas las novedades. El catálogo electrónico Silca es el asistente ideal para las actividades de la oficina, gestionar las referencias en stock, crear automáticamente los pedidos, imprimir etiquetas y mucho más.



LIVRARIA SILCA

Este catálogo atualiza e completa as informações sobre todas as chaves planas para fechaduras com cilindro, chaves tetra, para elevadores e caixas postais produzidas pela Silca.

Desejando manter os catálogos sempre atualizados, entre no nosso site www.silca.biz. Cada mês você saberá quais são as novas chaves produzidas consultando e imprimindo os boletins "Silca News".

CATÁLOGO ELETRÔNICO CHAVES

A Silca coloca à sua disposição um catálogo eletrônico com todos os catálogos impressos. Atualiza, em tempo real todas as novidades inclusive através de smartphones. O catálogo eletrônico Silca é o assistente ideal para o escritório, para a gestão das referências de estoque, para a criação automática de pedidos, imprimir etiquetas e muito mais.

EKC.SILCA.BIZ - ELECTRONIC KEY CATALOGUE

EKC contains all of the regularly updated Silca catalogues.

EKC contiene tutti i cataloghi Silca aggiornati con regolarità. Per scaricarli basta un click.

EKC, der elektronische Schlüsselkatalog, enthält alle Silca Kataloge, die hier regelmäßig aktualisiert werden.

Sie können diese mit nur einem Klick herunterladen.

EKC contient tous les catalogues d'ébauches Silca régulièrement mis à jour. Pour le télécharger, un seul clic suffit.

EKC contiene todos los catálogos Silca actualizados periódicamente. Para descargarlos es suficiente un clic.

EKC contém todos os catálogos Silca atualizados regularmente.

INDEX - TERMINOLOGIA - TERMINOLOGIE - TERMINOLOGIE - TERMINOLOGIA - TERMINOLOGIA

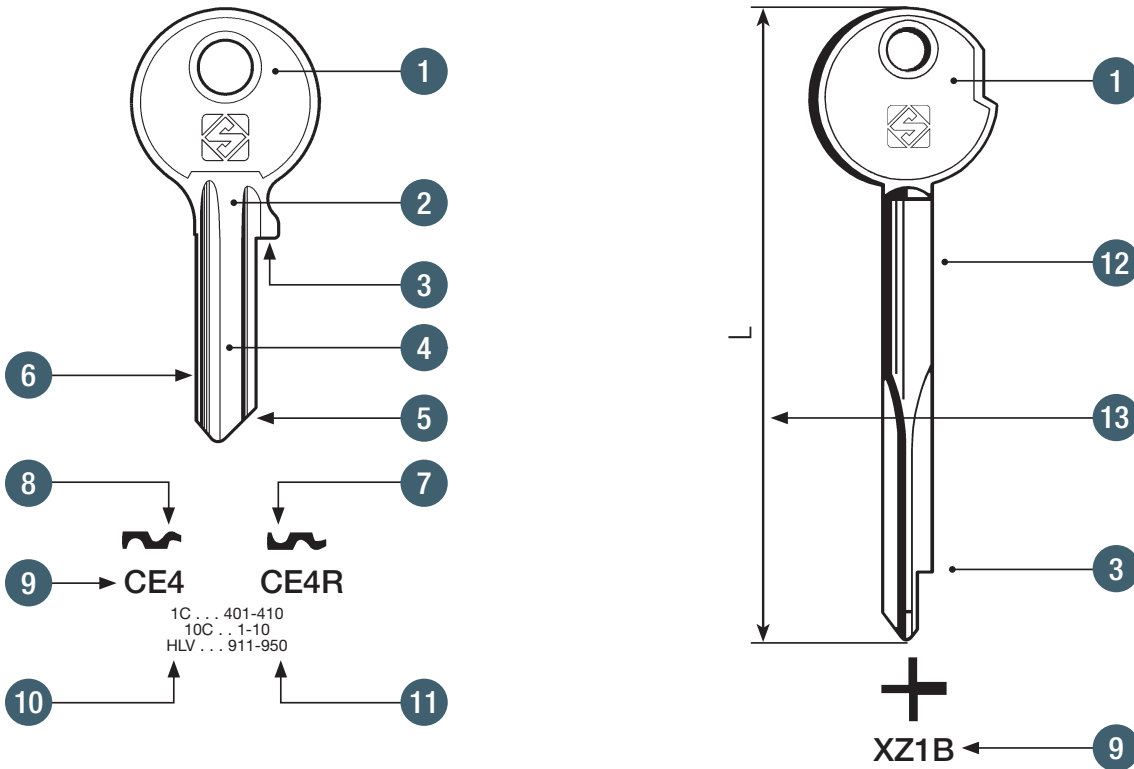

1	Head	Testa	Kopf	Tête	Cabeza	Cabeça
2	Neck	Collo	Hals	Cou	Cuello	Colo
3	Shoulder	Fermo	Anschlag	Arrêt	Tope	Encosto
4	Blade (stem)	Canna	Stange	Canon	Caña	Cana
5	Tip	Punta	Spitze	Pointe	Punta	Ponta
6	Back	Dorso	Rücken	Dos	Dorso	Dorso
7	Left hand profile	Profilo sinistro	Linkes Profil	Profil gauche	Perfil izquierdo	Perfil esquerdo
8	Right hand profile	Profilo destro	Rechtes Profil	Profil droit	Perfil derecho	Perfil direito
9	Silca item	Art. Silca	Silca-Artikel	Article Silca	Artículo Silca	Artigo Silca
10	Original profile	Profilo originale	Originalprofil	Profil original	Perfil original	Perfil original
11	Code	Serie	Serie	Code	Serie	Códigos
12	Stem	Gambo	Halm	Canon	Pala	Haste
13	Length	Lunghezza	Nötige Länge	Longueur	Longitud	Comprimento

INDEX - TERMINOLOGIA - TERMINOLOGIE - TERMINOLOGIE - TERMINOLOGIA - TERMINOLOGIA

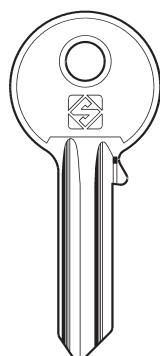

Information including material type is shown alongside each key.

A fianco di ogni chiave sono specificate alcune caratteristiche tecniche e varianti disponibili.

Neben jedem Schlüssel sind einige technische Daten und mögliche Varianten angegeben.

A côté de chaque clé sont indiqués les caractéristiques techniques et matériaux disponibles.

Al lado de cada llave se especifican datos técnicos y variantes disponibles.

Ao lado de cada chave estão indicadas algumas características técnicas e as variantes disponíveis.

	Standard production material:	Materiale di normale produzione:	Material von normaler Produktion:	Matériel standard:	Material de producción corriente:	Matéria-prima standard:
	Steel	Acciaio	Stahl	Acier	Acero	Aço
	Brass	Ottone	Messing	Laiton	Latón	Latão
	Nickel silver	Alpaca	Neusilber	Maillechort	Alpaca	Alpaca
	Iron	Ferro	Eisen	Fer	Hierro	Ferro
123	Head-shape code adjacent to each key for easy identification of customized coining dies	Codice testa per facilitare la scelta di conii personalizzati	Kopf-Code, um die Auswahl der Prägungen zu erleichtern	Code de la tête pour faciliter le choix des frappes personnalisées	Código de la cabeza para facilitar la elección de acuñaciones personalizadas	Código da cabeça para facilitar a escolha dos cunhos, no caso dos pedidos de chaves personalizadas
	Available in SILCA COLOR / SLIM COLOR	Disponibile in SILCA COLOR / SLIM COLOR	Lieferbar in SILCA COLOR / SLIM COLOR	Disponibile in SILCA COLOR / SLIM COLOR	Disponibile in SILCA COLOR / SLIM COLOR	Disponível em SILCA COLOR / SLIM COLOR
	Available in ULTRALITE	Disponibile in ULTRALITE	Lieferbar in ULTRALITE	Disponibile in ULTRALITE	Disponibile in ULTRALITE	Disponível em ULTRALITE
	Available in SILKY	Disponibile in SILKY	Lieferbar in SILKY	Disponibile in SILKY	Disponibile in SILKY	Disponível em SILKY
	No. of big pins	Nr. spine grandi	Nr. grosse Dornen	Nr. grands pistons	Nr. de agujas grandes	Nr. de pivos grandes
	No. of small pins	Nr. spine piccole	Nr. kleinen Dornen	Nr. petits pistons	Nr. de agujas pequenas	Nr. de pivos pequenos
	Back milled profile	Profilo dorsato	Rückengefrästes Profil	Profil à chiffrage dorsal	Perfil lomeado	Perfil boleado no dorso
	Card Number for cutting by code on Silca electronic machines for flat keys.	Numero scheda per riproduzione a codice con macchine elettroniche Silca per chiavi piatte.	Kartenummer für die Kopierung nach Code auf Silca Elektronische Schlüsselkopiermaschine für Flachschlüssel.	Numéro de fiche pour la reproduction à code sur machines électroniques Silca pour clés plates.	Número de la ficha para la reproducción en base a código con duplicadoras electrónicas Silca para llaves planas.	Número de ficha técnica para a duplicação pelo código nas máquinas electrónicas Silca (chaves planas).
S56	Silca Serial Number for cutting by code on Silca electronic machines for dimple and laser keys.	Silca Serial Number per riproduzione a codice su duplicatrici elettroniche Silca per chiavi punzonate e laser.	Silca Serial Number für die Kopierung nach Code auf Silca Elektronische Schlüsselkopiermaschine für Bohrmulden Schlüssel und Bahnen-Schlüssel.	Silca Serial Number pour la reproduction à code sur machines électroniques Silca pour clés a points et clés avec taille de type laser.	Silca Serial Number para la reproducción en base a código con duplicadoras electrónicas Silca para llaves de punto y llaves de regatas.	Silca Serial Number para a duplicação pelo código nas máquinas electrónicas Silca (chaves de pontos e tipo laser).

KEY IDENTIFICATION - IDENTIFICAZIONE CHIAVE - SCHLÜSSELIDENTIFIKATION - IDENTIFICATION CLÉ - IDENTIFICACIÓN DE LA LLAVE - IDENTIFICAÇÃO DE UMA CHAVE

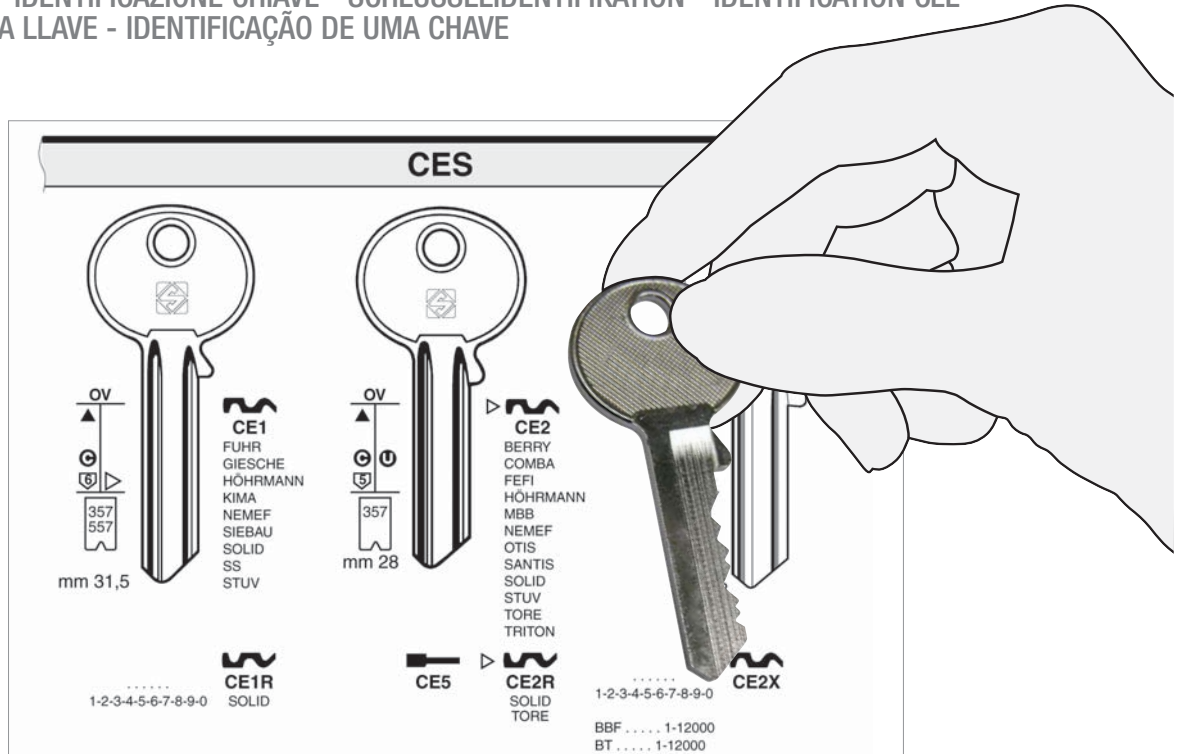

Keys are drawn to a 1:1 scale

Identification of a key may be made by laying the sample on the drawing, paying particular attention to the blade and to the profile.

Alternative head shapes are indicated by images around the standard head.



I disegni delle chiavi sono in scala 1:1

I profili (sezione della canna) sono visti dalla testa. Per la ricerca basta sovrapporre la chiave campione al disegno esaminando particolarmente la canna (gambo) e la sezione (profilo).

Teste originali diverse sono rappresentate con linea tratteggiata.



Die Zeichnungen der Schlüssel sind in Skala 1:1

Die Profile (Schnitt der Stange) werden vom Kopf ab gesehen. Für die Suche genügt es den Musterschlüssel mit der angegebenen Zeichnung zu vergleichen, aber wir empfehlen, besonders die Stange und das Profil zu überprüfen.

Verschiedene Originalköpfe sind durch gestrichelte Linien dargestellt.



Les dessins des clés sont à échelle 1:1

Les profils (section du canon) sont vus de la tête. Pour la recherche il suffira de superposer la clé échantillon au dessin en examinant tout particulièrement le canon (tige) et la section (profil).

Têtes originales différentes sont représentées par des lignes en tirets.



Los dibujos de las llaves son en escala 1:1

Los perfiles (sección de la caña) son vistos de la cabeza. Para la búsqueda basta sobreponer la llave de muestra al dibujo, examinando con particular atención la caña y la sección.

Las cabezas originales diferentes están representadas con una línea punteada.



Os desenhos das chaves estão em escala 1:1

Os perfis (secção da cana) são vistos da cabeça. Para uma pesquisa eficiente, basta sobrepor a chave original por cima do desenho e examinar atentamente a cana da chave e o perfil.

Cabeças originais diferentes estão representadas com uma linha tracejada.

USES - UTILIZZI - VERWENDUNGEN - UTILISATION - UTILIZACIONES - UTILIZAÇÕES

						
	Security cylinders	Cilindri di sicurezza	Sicherheitszylinder	Cylindres de sécurité	Cilindros de seguridad	Cilindros de segurança
	Dimple keys	Chiavi punzonate	Bohrmuldenschlüssel	Clés à points	Llaves de seguridad	Chaves de pontos
	Electric boards	Quadri elettrici	Schalttafel	Tableaux électriques	Cajas eléctricas	Quadros eléctricos
	Cash register locks	Registratori di cassa	Registriermaschine	Caisse enregistreuse	Registradoras de caja	Caixas registradoras
	Furniture locks	Cilindri per mobill	Möbelzylinder	Cylindres pour meubles	Cilindros para muebles	Cilindros para mobiliário
	Steering column locks	Bloccasterzo	Lenkschlösser	Blocage volant	Bloqueo para direcció	Bloqueios da direcção
	Padlocks	Lucchetti	Vorhangschlösser	Cadenas	Candados	Cadeados
	Shutter locks	Serrature per serranda	Fallturschlösser	Serrures pour stores métalliques	Cerraduras para cortinas metálicas	Fechaduras para grades de enrola
	Phone locks	Bloccatelefono	Telefonschlösser	Blocage du téléphone	Bloqueo para teléfonos	Bloqueios de telefone
	Glass door locks	Bloccacristalli	Glasschiebetürschlösser	Blocage porte en verre	Bloqueos para cristales	Trava dos vidros
	Locomotives	Locomotive	Lokomotive	Locomotive	Locomotora	Locomotivas
	Electric locks	Serrature elettriche	Elektrische Schlösser	Serrures électriques	Cerraduras eléctricas	Fechaduras eléctricas
	Briefcases	Valigette	Köfferchen	Mallettes	Maletines	Maletas
	Safes	Cassette di sicurezza	Sicherheitsfach	Coffres-forts	Caja de seguridad	Cofres
	Lifts	Ascensori	Aufzüge	Ascenseurs	Ascensores	Elevadores
	Juke box / Flipper	Juke box / Flipper	Juke box / Spielautomaten	Juke box / Flipper	Juke box / Flipper	Juke box / Flipper
	Mail boxes	Casellari postali / Cassette per lettere	Fachkasten	Boîtes postales / Boîtes aux lettres	Casillas postales / Buzones	Caixas de correio
	Antitheft devices for motor-cycles	Antifurto per ciclomotori / motociclette	Diebstahlschutz für Motorfahrrad und Motorräder	Antivols pour cyclomoteurs / motocyclettes	Antihurto para ciclomotores y motocicletas	Anti-roubo para scooters e motocicletas

TECHNICAL INFORMATION - INFORMAZIONI TECNICHE - TECHNISCHE AUSKÜNFTEN - INFORMATIONS TECHNIQUES - INFORMACIONES TÉCNICAS - INFORMAÇÕES TÉCNICAS



2

PER / FOR

ABLOY (S)

ABT (I)

VIRO (135)

ABUS (D)

BRICARD

CISA

GEGE

JPM

OTHMER

TOP

+ CISA (31-32-33)

+ GUERVILLE RIQUEUR (63)

PER:
FOR:

ABLOY

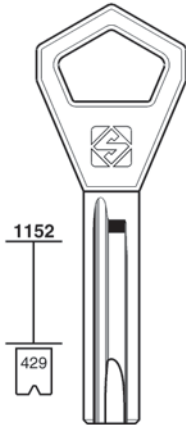

AY18
NAB

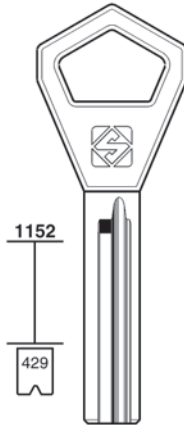

AY20
TAJ

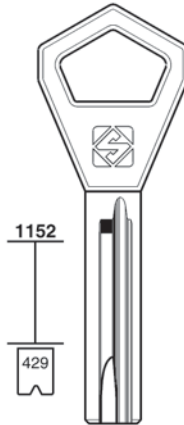

AY21
TAB

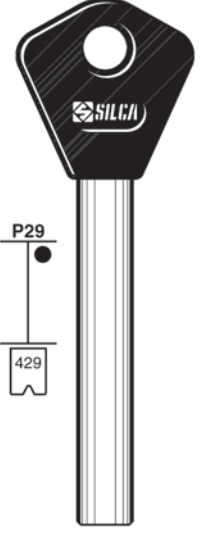

AY10P



0-1-2-3-4-5-6-7-8-9



0-1-2-3-4-5-6-7-8-9

PER:
FOR:

ABUS

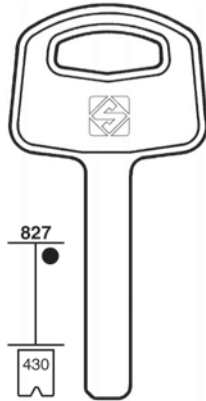

827

430



P214



Use (page XI)

Utilizzo (pag. XI)

Verwendung (Seite XI)

Utilisation (page XI)

Uso (pág. XI)

Utilização (pág. XI)

TECHNICAL INFORMATION - INFORMAZIONI TECNICHE - TECHNISCHE AUSKÜNFTTE - INFORMATIONS TECHNIQUES - INFORMACIONES TÉCNICAS - INFORMAÇÕES TÉCNICAS

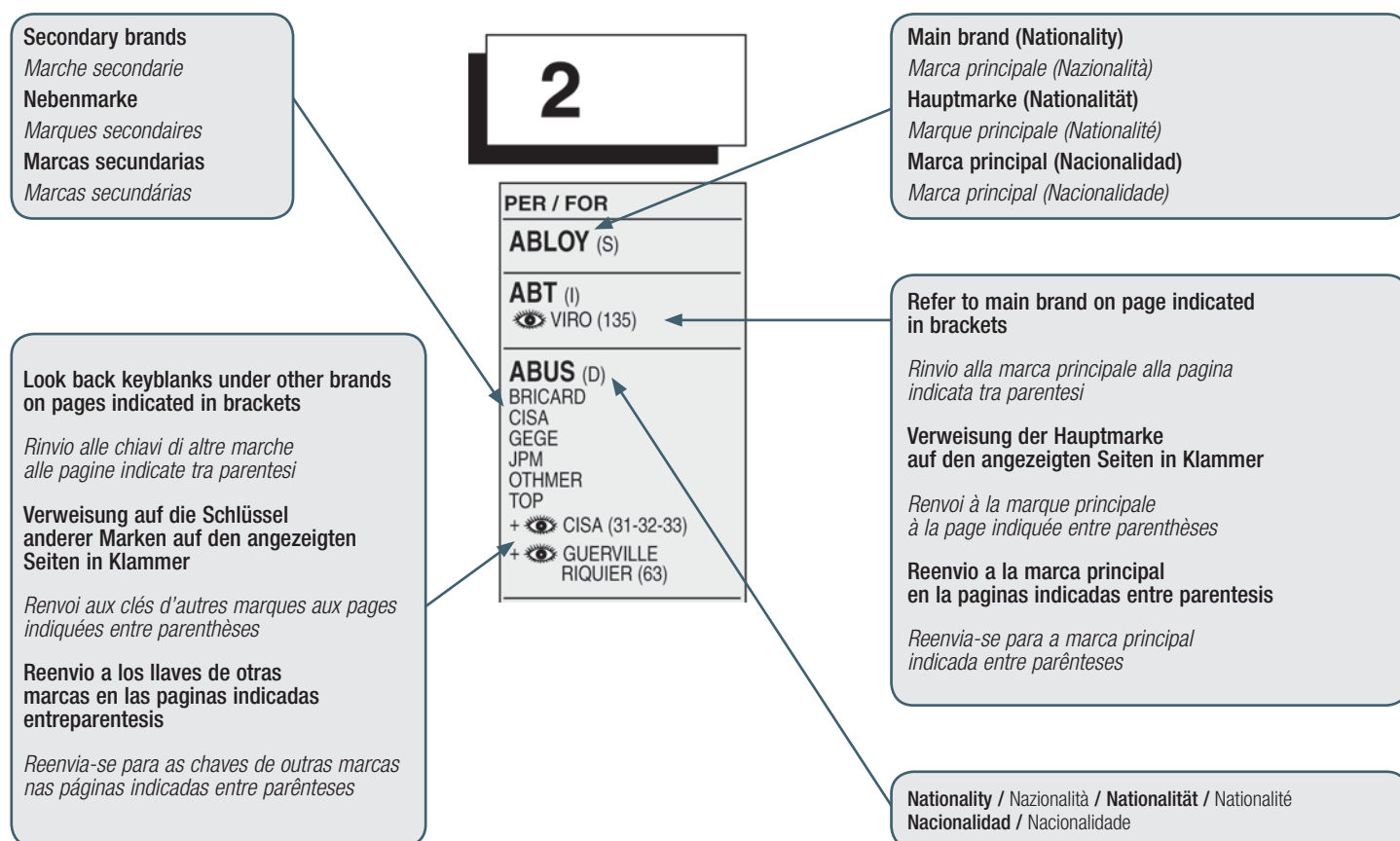

NATIONALITY / NAZIONALITÀ / NATIONALITÄT / NATIONALITÉ / NACIONALIDAD / NACIONALIDADE

A	Austria	E	Spain	J	Japan	RO	Romania
AUS	Australia	EST	Estonia	KSA	Saudi Arabia	RUS	Russia
AZ	Azerbaijan	ET	Egypt	LT	Lithuania	S	Sweden
B	Belgium	F	France	LV	Latvia	SRB	Serbia
BG	Bulgaria	FIN	Finland	MD	Republic of Moldova	SLO	Slovenia
BR	Brazil	GB	Great Britain	N	Norway	SU	ex-URSS
BY	Belarus	GR	Greece	NL	The Netherlands	TN	Tunisia
CDN	Canada	H	Hungary	P	Portugal	TR	Turchia
CH	Switzerland	HK	Hong-Kong	PL	Poland	USA	United States of America
CO	Colombia	HR	Croatia	PRC/CN	China	UA	Ukraine
CZ	Czech. Repub.	I	Italy	RC/TW	Taiwan	WAN	Federal Republic of Nigeria
D	Germany	IL	Israel	RA	Argentina	YV	Venezuela
DK	Denmark	IND	India	RCH	Chile	ZA	Republic of South Africa
DZ	Algeria	IRL	Ireland	RNR	Zambia		

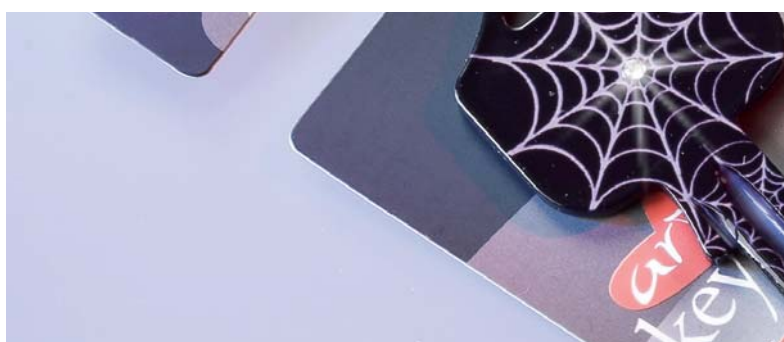





The result of a creative combination of materials and colours, Ultralite keys are made in a super light, extremely resistant titanium, and are used for the construction of airplanes and spacecraft. Ultralite keys are available in 7 vibrant colours: red, green, blue, yellow, black, light blue and purple.

Dear Customer,

*We would like to remind you that due to the almost totality of items without plastic heads included in this catalogue, an Ultralite finish may be requested, which if not already existing has availability marked by the symbol **U** next to each key item.*



Risultato di una creativa combinazione di materiali e colori, le chiavi Ultralite sono prodotte in una lega al titanio leggerissima ed estremamente resistente, tanto da venire utilizzata per la costruzione di aerei e navette aerospaziali. Ultralite è disponibile in ben 7 vivaci colori diversi: rosso, verde, blu, giallo, nero, celeste, viola.

Gentile Cliente,

*le ricordiamo che la quasi totalità degli articoli non a testa plastica inclusi nel presente catalogo può essere richiesta in finitura Ultralite, qualora non ne esista già la disponibilità contrassegnata dal simbolo **U** nella griglia accanto a ciascun articolo chiave.*



Die Ultralite Schlüssel sind das Ergebnis einer kreativen Kombination von Farben und Materialien. Sie werden aus einer sehr leichten und extrem widerstandsfähigen Titanlegierung hergestellt, die sogar in der Raum- und Luftfahrt eingesetzt wird. Ultralite Schlüssel sind in 8 verschiedenen lebhaften Farben erhältlich: rot, grün, blau, gelb, schwarz, silber, hellblau und violett.

Sehr geehrter Kunde,

*wir möchten Sie darauf hinweisen, dass fast alle Artikel in unserem Katalog ohne Plastik-Schlüsselkopf mit der Ultralite-Technologie lieferbar sind, falls der Artikel nicht bereits mit dem entsprechenden Symbol **U** daneben gekennzeichnet sein sollte.*



Résultat d'une combinaison créative de matériaux et de couleurs, les clés Ultralite sont produites dans un alliage de titane extrêmement léger et résistant utilisé également pour la construction des avions et des navettes spatiales. Ultralite est disponible en 7 couleurs vives: rouge, vert, bleu, jaune, noir, bleu clair et violet.

Cher Client,

*Nous vous rappelons qu'il est possible de demander la finition Ultralite pour la quasi-totalité des articles sans tête en plastique figurant dans ce catalogue, si la disponibilité n'est pas déjà indiquée par le symbole **U** dans la grille à côté de chaque article.*



Resultado de una creativa combinación de materiales y colores, las llaves Ultralite se realizan con una aleación de titanio tan ligera y resistente que se utiliza para la construcción de aviones y naves espaciales. Ultralite está disponible en 7 colores vivos: rojo, verde, azul marino, amarillo, negro, azul celeste y violeta.

Estimado cliente:

*Le recordamos que casi todos los artículos que no llevan la cabeza de plástico, incluidos en este catálogo, pueden pedirse con acabado de Ultralite si no están ya disponibles en esta versión; en este caso, en la correspondiente tabla adyacente, las llaves **U** están marcadas con el símbolo.*



Resultado de uma criativa combinação de materiais e cores, as chaves Ultralite são fabricadas em liga de titânio, extremamente leve e resistente, tanto que tal material é utilizado na construção de aviões e naves aeroespaciais. Ultralite está disponível em 7 cores vivas: vermelho, verde, azul, amarelo, preto, azul celeste, violeta.

Prezado Cliente,

*gostaríamos de lembrar que, para quase todos os artigos sem a cabeça de plástico incluídos neste catálogo, pode ser que seja necessário o acabamento Ultralite, isto se não houver a disponibilidade assinalada pelo símbolo **U** na grade ao lado de cada artigo chave.*

Available colours:





With Silky, colour takes on a new shape.

Five colours and a special material for a new interpretation in glossy keys of the most common items. Colour becomes an integral part of the key without modifying its depth.

New, dazzling, resistant: this is Silky, the latest from Silca. Customize Silky with your information!
Silky: Silca quality in colour.



Con Silky il colore prende nuova forma.

Cinque tonalità e un materiale speciale per una reinterpretazione in chiave brillante degli articoli più diffusi. Il colore diventa parte integrante della chiave senza modificarne lo spessore. Nuova, smagliante, resistente: ecco Silky, ultima nata in casa Silca. Personalizzate Silky con i vostri dati!

Silky: la qualità Silca si colora.



Mit Silky erhält Farbe eine neue Form.

Fünf Farbtöne und ein Spezialmaterial für eine neue, glanzvolle Interpretation der gängigsten Schlüsselprofile.

Die Farbe des fest angespritzten Kennrings wird zu einem wesentlichen Bestandteil des Schlüssels, ohne seine Stärke zu verändern. Glänzend und widerstandsfähig, das ist Silky, der etwas andere Schlüssel aus dem Hause Silca. Gestalten Sie Ihren Silky Schlüssel individuell mit Ihren Daten!

Silky: die Qualität von Silca nimmt Farbe an.

SILKY®



Avec Silky, la couleur prend une nouvelle forme.

Cinq teintes et un matériau spécial pour une réinterprétation brillante des articles les plus répandus. La couleur devient partie intégrante de la clé, sans en modifier l'épaisseur.

Nouveau, brillant, résistant: voici le modèle Silky, dernier né de la maison Silca.

Personnalisez Silky avec votre nom!

Silky: la qualité Silca prend de la couleur.



Con Silky, el color toma una nueva forma.

Cinco tonos y un material especial para una reinterpretación en clave brillante de los artículos más difundidos. El color se convierte en parte integrante de la llave sin modificar su espesor.

Nueva, brillante y resistente: he aquí Silky, la última creación de Silca.

¡Personalice Silky con sus datos!

Silky: la calidad Silca se colorea.



Com Silky a cor assume uma nova forma.

Cinco tonalidades e um material especial para uma reinterpretação brilhante dos artigos mais populares. A cor torna-se parte integrante da chave sem alterar a sua espessura.

Nova, brilhante, resistente: eis a Silky, a mais recente produzida pela Silca.

Personalize a Silky com os seus dados!

Silky: a qualidade Silca fica colorida.

Available colours:



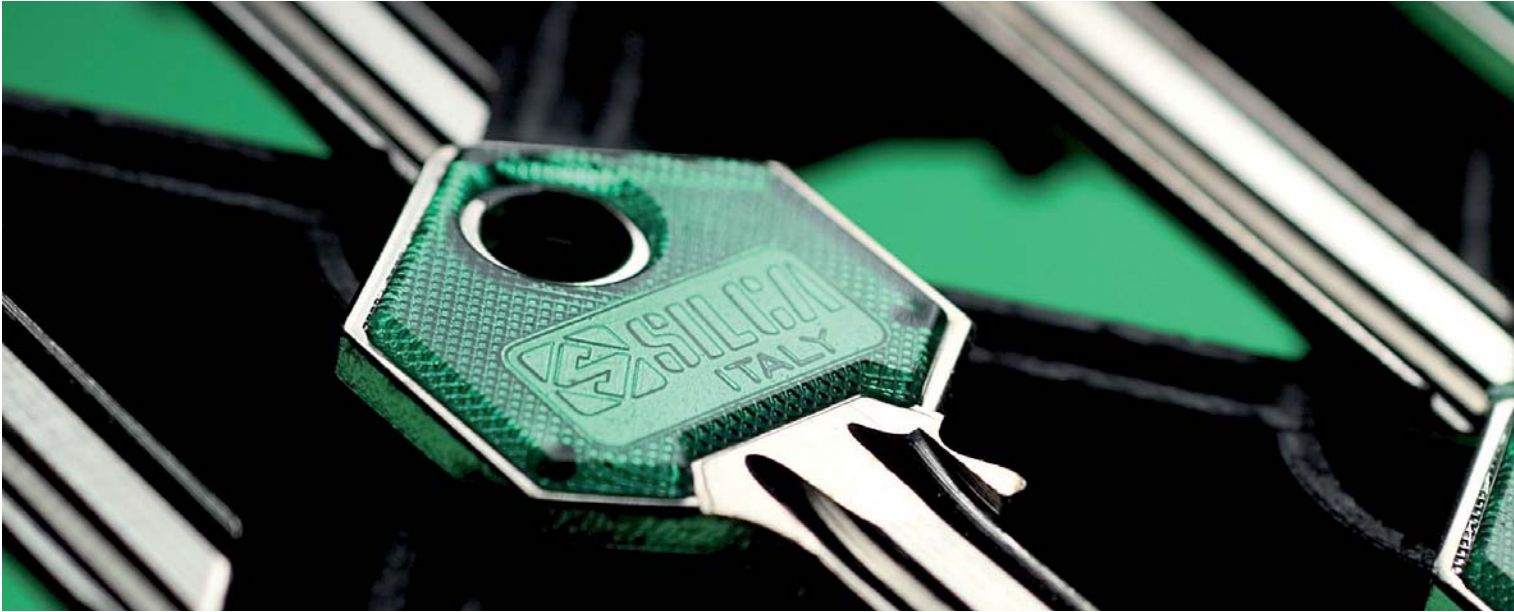

Choose the pure energy of colour!

Slim Colour is a brand new Silca item for your colored keys. Five fluorescent varieties that permit immediate identification of keys for different uses without having to significantly change their depths.

There are multiple advantages:

- Less depth
- Universal models with long necks and "L" shaped heads
- Original heads for profiles
- Five colours: fuchsia, blue, green, red, orange
- Assorted package



Scegliete l'energia pura del colore!

Slim Color è la nuova proposta Silca per le vostre chiavi colore. Cinque varianti fluorescenti che consentono di identificare immediatamente chiavi destinate a utilizzi diversi e senza modificarne in modo rilevante lo spessore.

I vantaggi sono molteplici:

- Spessore ridotto
- Universali con collo lungo testa "L"
- Teste originali per profili
- Cinque colori: fucsia, blu, verde, rosso, arancio
- Confezione assortita



Wählen Sie die pure Energie der Farbe!

Slim Color ist unser Vorschlag für Ihre farbigen Schlüssel. Fünf transparente Farbvarianten, mit denen Sie Ihre für unterschiedliche Zwecke bestimmten Schlüssel leicht erkennen können, ohne dass die Stärke des Schlüssels wesentlich verändert wird.

Die Schlüssel weisen zahlreiche Vorteile auf:

- Geringe Stärke
- Universalschlüssel mit L-Kopf und langem Hals
- Originalköpfe für die Profile
- Fünf verschiedene Farben: fuchsia, blau, grün, rot und orange
- Neu zusammengestellte Packung





Choisissez l'énergie pure de la couleur !

Slim color est la nouvelle proposition de Silca pour vos clés colorées. Cinq variantes fluorescentes qui vous permettent d'identifier immédiatement les clés destinées aux différents usages, sans modification de l'épaisseur.

Les avantages sont nombreux:

- Épaisseur réduite
- Profil Universel avec col long et tête en «L»
- Têtes originales
- Cinq couleurs: rose, bleu, vert, rouge, orange
- Boîtes assorties



Elija la energía pura del color!

Slim Color es la nueva propuesta Silca para sus llaves de color. Cinco colores fluorescentes que permiten identificar de inmediato las llaves destinadas a usos diferentes sin modificar demasiado su espesor.

Las ventajas son muchas:

- Espesor reducido
- Llaves universales con cuello largo y cabeza en "L"
- Cabezas originales para los perfiles
- Cinco colores: fucsia, azul marino, verde, rojo y naranja
- Cajas surtidas



Escolha a energia pura da cor!

Slim Color é a nova proposta Silca para as chave coloridas. Cinco variantes fluorescentes que permitem identificar imediatamente as chaves para diferentes usos e sem alterar a sua espessura.













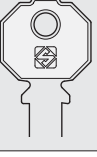
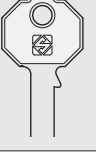

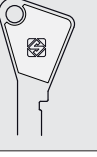

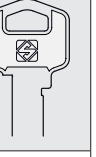
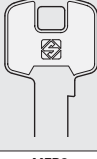

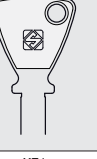

As vantagens são muitas:

- Espessura reduzida
- Universais com colo comprido e cabeça "L"
- Cabeças originais para perfis
- Cinco cores: fúcsia, azul, verde, vermelho, laranja
- Embalagem sortida

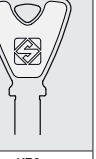

Available colours:



SLIM COLOR

22  SM1	29  OC074	31  PF092 PF092S PF2	33  PF1	54  CA2 R041 R08	60  VAC2	168  UNI3	182  YA1	369  TE2
423  MER8	599  AGB1R	745  RU14	1182  BD9R	1219  CS115	1557  MER1	1604  KE1	1605  KE3	1606  KE9
A  CB6 CS204 CS206 FM090 FM1 IE6 JM2R MTA1R UL050 UL051 VI080 VI082 WA1R WA2R	L  UL050SL UL051SL UL052SL UL053SL UL054SL UL055SL UL058SL YT15 YT16	N  CB85 CC1 CS7 IE3 UL058 VI084 VI086	OV  RU1 VAC151	Y  YA226 YA31 YA6				

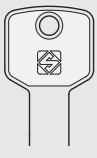
SLIM COLOR DIMPLE KEYS - SLIM COLOR CHIAVI PUNZONATE - SLIM COLOR BOHRMULDENSCHLÜSSEL - SLIM COLOR CLÉS À POINTS - SLIM COLOR LLAVES DE SEGURIDAD - SLIM COLOR CHAVES DE PONTOS

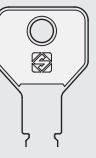
1130  IE15	1219  CS62	1275  AGB5 AGB8	1434  CB97	1456  CS146
--	---	---	---	--

COLOR

1	16	54	60	168	182	301	305	438
BE200	DX1	CA2	VAC3	UNI3	CEN1R	SH3	KA1	LW4
		EV10X1			YA1E			
		EV3R						
		EV69X						
		GE1X						
		GE7RX						
		GE8R						
717	745	A	FA	L	N	Y	OV	OV
BD6	RU14	AG2R	BAI1	UL050L	CC1	YA226	AB1X	DM3X
BD6R		AG3		UL050XL	UL058	YA31	BK1X	KF1
		UL050		UL051L			BK3-12	RU1
		UL051		UL052L			BK3-3	T01X
		UL054					BK3-4	T029X
		VAC29					BK3-7	UL050X
		VI080					BK3-8	WK1X
							CE1	ZE1
							CE2	ZE1RX
							CE2X	ZE1X
							DM3	ZE2



New subjects, more fun.

ART KEYS is the brand new Silca proposal for colouring your bunch of keys. There are hundreds of different designs to choose from, in addition to the possibility to request exclusive subjects not in the catalogue: customize your keys using your own ideas! To better make your selection from the Silca range of products, request a specific catalogue. You will recognize your keys immediately and you will also make yourself noticed!

IMPORTANT NOTE: Any item listed in this catalogue, except for keys with plastic heads, can be produced with the Art finish you select from the many contained in this catalogue. Silca also offers you the exclusive opportunity to customize your keys with subjects selected by you that are not present in this catalogue, or to create a customized colored key that also contains your information, such as name, shop address, telephone number or other information, and your favourite graphic subject. Request more information and a dedicated catalogue from Silca or your Distributor!

art[®]
keys



Nuovi soggetti, più divertimento.

ART KEYS è la nuova proposta Silca per colorare il vostro mazzo di chiavi. Centinaia i motivi diversi tra cui poter scegliere, oltre alla possibilità di richiedere soggetti esclusivi non a catalogo: personalizzate le chiavi con le vostre stesse idee! Per scegliere al meglio all'interno della gamma Silca, richiedete il catalogo specifico. Riconoscete subito le vostre chiavi e fatevi riconoscere!

NOTA IMPORTANTE: Qualsiasi articolo contenuto nel presente catalogo, eccezion fatta per le chiavi con testa plastica, può essere realizzato con finitura Art a vostra scelta, tra le tante contenute nel catalogo. Silca vi offre inoltre l'opportunità esclusiva di personalizzare le chiavi con soggetti selezionati da voi e non presenti a catalogo, oppure di realizzare una chiave personalizzata colorata che contenga oltre ai vostri dati quale nome, indirizzo del negozio, telefono od altro, il soggetto grafico da voi preferito. Richiedete a Silca o al vostro Distributore di fiducia maggiori informazioni e il catalogo dedicato!



Neue Motive für mehr Spaß.

ART KEYS ist das neue Angebot von Silca, um Ihren Schlüsselbund farbiger zu gestalten. Hunderte von verschiedenen Motiven zur Auswahl. Darüber hinaus haben Sie die Möglichkeit, exklusive Designs und Abbildungen anzufordern, die nicht im Katalog enthalten sind. Verleihen Sie den Schlüsseln mit Ihren Ideen eine persönliche und unverwechselbare Note!

Fragen Sie nach der Sonderbroschüre, damit Sie das Beste aus der Produktpalette Silca wählen können. Erkennen Sie sofort Ihre Schlüssel und machen Sie auf sich aufmerksam!

WICHTIGER HINWEIS: Alle Artikel in diesem Katalog, mit Ausnahme der Schlüssel mit Plastikkopf, können als Art Keys Ihrer Wahl aus den zahlreichen Katalogmotiven geliefert werden. Silca bietet Ihnen darüber hinaus die einmalige Gelegenheit, die Schlüssel mit Motiven Ihrer Wahl, die nicht im Katalog enthalten sind, individuell zu gestalten, oder einen farbigen Schlüssel mit persönlicher Note zu realisieren, der nicht nur Ihre Daten wie Name, Geschäftsadresse, Telefonnummer usw. enthält, sondern auch das Fantasiemuster Ihrer Wahl. Fragen Sie bei Silca oder dem Vertriebspartner Ihres Vertrauens nach weiteren Informationen und fordern Sie den Sonderkatalog an!



THE SIMPSONS® & © 2000
 Twentieth Century Fox Film Corporation,
 All Rights Reserved.



De nouveaux modèles, un plus grand plaisir.

ART KEYS est la nouvelle proposition de Silca pour donner de la couleur à votre trousseau de clés. Un choix incluant des centaines de modèles différents, sans oublier la possibilité de demander des créations exclusives hors catalogue: personnalisez vos clés avec vos propres idées

Pour choisir au mieux dans la gamme Silca, demandez le catalogue dédié à ce produits. Reconnaissez immédiatement vos clés et démarquez-vous!

NOTE IMPORTANTE: Tous les articles figurant dans ce catalogue, à l'exception des clés avec tête en plastique, peuvent être réalisés avec la finition ART de votre choix, parmi les nombreuses propositions figurant au catalogue. Silca vous offre également l'opportunité exclusive de personnaliser les clés avec des éléments choisis par vous hors catalogue, ou encore de réaliser une clé personnalisée en couleur contenant des informations telles que votre nom, l'adresse de la boutique, le téléphone ou autre, ainsi que le graphisme de votre choix. Contactez Silca ou votre revendeur de confiance pour plus d'informations et pour obtenir un catalogue spécifique!



Nuevos temas, más diversión.

ART KEYS es la nueva propuesta Silca para colorear su manajo de llaves. No solo puede elegir entre centenares de motivos diferentes sino que también puede pedir temas exclusivos, no presentes en el catálogo: ¡personalice las llaves con sus ideas!

Para poder elegir mejor dentro de la gama Silca, solicite el catálogo específico. ¡Reconozca sus llaves de inmediato y dese a conocer!

NOTA IMPORTANTE: cualquier artículo del presente catálogo, con excepción de las llaves con cabeza de plástico, puede realizarse con el acabado Art que usted desee, a elegir entre los muchos disponibles. Silca también le ofrece la oportunidad exclusiva de personalizar las llaves con temas seleccionados por usted, no presentes en el catálogo, o bien de realizar una llave personalizada coloreada que incluya, además de datos como el nombre, la dirección de la tienda, el teléfono, etc., el tema gráfico que usted prefiera. ¡Solicite a Silca o su distribuidor de confianza más información y el catálogo correspondiente!



Novos motivos, mais diversão.

ART KEYS é a nova proposta especial da Silca para colorir o seu molho de chaves. Centenas de padrões diferentes entre os quais escolher, além da possibilidade de solicitar reproduções exclusivas não mostradas no catálogo: com as quais personalizar as suas chaves e com as suas próprias idéias!

Para poder escolher o melhor entre as propostas da gama Silca, solicite o catálogo específico. Reconheça as suas chaves e deixe-se reconhecer!

NOTA IMPORTANTE: Qualquer artigo existente neste catálogo, exceto para as chaves com cabeça de plástico, pode ser realizado com acabamento Art a seu gosto, entre os diversos exibidos no catálogo. Silca também oferece a oportunidade exclusiva de personalizar as chaves com temas por você selecionados e não existentes no catálogo, ou então, realizar uma chave personalizada colorida que contenha, além dos seus dados tais como, nome, endereço comercial, telefone ou outros, o seu motivo preferido. Solicite, à Silca ou ao seu Distribuidor de confiança, mais informações e o catálogo específico!



PUPIES COLLECTION

Puppies Collection is the Art Keys collection dedicated in particular to puppies.

Eight subjects, eight moments of tenderness, actually double tenderness, thanks to the coordinated key holders.

NATURE COLLECTION

Silca dedicates to all nature lovers the keys and key holders from the "Nature Collection" series. Open the door to the charming world of animals!

PATTERN COLLECTION

Innovative, new, dazzling. Hundreds of different themes to choose from, in addition to the possibility to request exclusive subjects not listed in the catalogue to customize your keys.

THE SIMPSONS™ COLLECTION

The new The Simpsons™ family in the world of security! Don't miss the chance to insert the characters from "The Simpsons™" into your bunch of keys. 18 available subjects.

DIAMOND COLLECTION

Be brilliant... choose Silca Diamond! Unique, exclusive, luminous. Many available subjects.



PUPIES COLLECTION

Puppies Collection è la collezione Art Keys dedicata agli animali e in particolare ai cuccioli.

Otto soggetti, otto occasioni di tenerezza, anzi di doppia tenerezza, grazie ai portachivi coordinati.

NATURE COLLECTION

Silca dedica a tutti gli amanti della natura le chiavi e i portachivi della serie "Nature Collection".

Aprite la porta all'affascinante mondo degli animali!

PATTERN COLLECTION

Innovative, nuove, accattivanti. Centinaia di motivi diversi tra cui poter scegliere, oltre alla possibilità di richiedere soggetti esclusivi non a catalogo per personalizzare le vostre chiavi.

THE SIMPSONS™ COLLECTION

La nuova famiglia The Simpsons™ nel mondo della Sicurezza! Non perdere l'occasione di inserire i personaggi "The Simpsons™" all'interno del tuo mazzo di chiavi. 18 soggetti disponibili.

DIAMOND COLLECTION

Sii brillante...scegli Silca Diamond! Unica, esclusiva, luminosa. Numerosi soggetti disponibili.



PUPIES COLLECTION

Puppies Collection ist die den Tierbaby's gewidmete Art Keys Kollektion.

Acht verschiedene Tierbaby's, die dem Schlüsselbund Individualität verleihen.

NATURE COLLECTION

Silca widmet allen Naturliebhabern diese Schlüssel. Treten Sie ein in die faszinierende Welt der exotischen Tiere!

PATTERN COLLECTION

Innovativ, neu, faszinierend. Hunderte von verschiedenen Motiven zur Auswahl. Auf Anfrage sind auch exklusive, nicht im Katalog enthaltene Motive lieferbar, um Ihren Schlüsseln eine persönliche Note zu verleihen.

THE SIMPSONS™ COLLECTION

The Simpsons™ Familie in der Welt der Sicherheit! Verpassen Sie nicht die einmalige Gelegenheit, Ihren Schlüsselbund mit den Figuren aus der beliebten Serie "The Simpsons™" zu versehen. Wählen Sie aus einem Sortiment von fast 30 verschiedenen Motiven.

DIAMOND COLLECTION

Seien Sie brillant...wählen Sie Silca Diamond! Einzigartig, exklusiv, strahlend. Zahlreiche attraktive Motive.



The Simpsons™ are sold under license
Distributrice SA (DSA) TM© 2000 FOX D.S.A.



PUPPIES COLLECTION

La collection Puppies est la collection Art Keys dédiée aux chiots.

Huit sujets graphiques, huit occasions de tendresse que les petits et les plus grands adoreront.

NATURE COLLECTION

Silca dédie à tous les amoureux de la nature, les clés et les porte-clés de la série «Nature Collection».

Ouvrez la porte au monde fascinant des animaux

PATTERN COLLECTION

Innovantes et attrayantes. Des centaines de modèles différents, ainsi que la possibilité de demander des dessins exclusifs hors catalogue pour personnaliser vos clés.

THE SIMPSONS™ COLLECTION

La nouvelle famille The Simpsons™ dans le monde de la sécurité! Ne perdez pas l'occasion d'introduire les personnages de la série «The Simpsons™» dans votre trousseau de clés. 18 sujets disponibles.

DIAMOND COLLECTION

Soyez brillant... choisissez Silca Diamond!

Unique, exclusive, lumineuse. De nombreux sujets disponibles.



PUPPIES COLLECTION

Puppies Collection es la colección Art Keys dedicada a los animales y, en concreto, a los cachorros.

Ochos temas y ocho oportunidades de ternura o, mejor dicho, de doble ternura gracias a los llaveros que hacen juego.

NATURE COLLECTION

Silca dedica a todos los amantes de la naturaleza las llaves y los llaveros de la serie "Nature Collection".

¡Abra la puerta al fascinante mundo de los animales!

PATTERN COLLECTION

Innovadoras, vanguardistas y encantadoras. Centenares de temas diferentes entre los que elegir, además de poder pedir temas exclusivos, no presentes en el catálogo, para personalizar sus llaves.

THE SIMPSONS™ COLLECTION

¡La nueva familia The Simpsons™ en el mundo de la seguridad! No pierda la ocasión de utilizar los personajes de "The Simpsons™" para decorar su manajo de llaves. 18 temas disponibles.

DIAMOND COLLECTION

¡Sea brillante... elija Silca Diamond!

Única, exclusiva y luminosa. Numerosos temas disponibles.



PUPPIES COLLECTION

Puppies Collection é a coleção Art Keys Collection destinada aos filhotes de animais.

Oito sujeitos, oito ocasiões de ternura, ou melhor de dupla ternura, graças aos porta-chaves coordenados.

NATURE COLLECTION

Silca dedica a todos os amantes da natureza as chaves e os porta-chaves da série "Nature Collection".

Abra a porta ao fascinante mundo dos animais!

PATTERN COLLECTION

Inovadoras, novas, atraentes. Centenas de padrões diferentes entre os quais escolher, além da possibilidade de solicitar reproduções exclusivas não mostradas no catálogo para personalizar as suas chaves.

THE SIMPSONS™ COLLECTION

A nova família The Simpsons™ no mundo da Segurança! Não perca a ocasião de inserir as personagens do desenho animado "The Simpsons™" no seu molho de chaves. 18 sujeitos disponíveis.

DIAMOND COLLECTION

Seja brilhante... escolha Silca Diamond!

Única, exclusiva, luminosa. Numerosos motivos disponíveis.



Silca keys can be customized based on your selections in numerous ways: with an image of your city, with your name or trademark, with an address or telephone number of your business to remind your Customers where they can always count on impeccable keys.



Le chiavi Silca possono essere personalizzate, a Vostra scelta, in numerosi modi: con un'immagine della vostra città, con il vostro nome o marchio, con l'indirizzo o il numero di telefono del vostro negozio per ricordare ai vostri Clienti dove trovare un servizio chiavi impeccabile.



Silca Schlüssel können nach Ihrer Wahl auf unzählige Art und Weise persönlich gestaltet werden. Mit der Abbildung Ihrer Stadt, mit Ihrem Namen und Ihrer Marke oder mit der Anschrift und Telefonnummer Ihres Geschäfts, damit Ihre Kunden wissen, wo sie den spezialisierten und fachmännischen Schlüsseldienst finden.





Les clés Silca peuvent être personnalisées de nombreuses façons: avec une image de votre ville, avec votre nom ou votre marque, avec l'adresse ou le numéro de téléphone de votre magasin pour rappeler à vos clients où trouver un service de reproduction de clés de qualité.



Las llaves Silca se pueden personalizar, a su elección, de muchas maneras: con una imagen de su ciudad, con su nombre o marca o, también, con la dirección o el número de teléfono de su tienda, para recordar a sus clientes dónde encontrarán un servicio de llaves inmejorable.



As chaves Silca podem ser personalizadas, a seu gosto, e de várias formas: com a imagem da sua cidade, com o seu nome ou marca, com o endereço ou o número de telefone da sua loja para que os seus Clientes se lembrem onde encontrar um serviço de duplicação de chaves impecável.



SERIE DISTINZIONE HEADS

For the most common keys Silca has created a series of 18 different exclusive heads called the "Serie Distinzione" to offer a wide range of possibilities to customize your keys. Choose your favourite heads: on the following pages you can find all available items with 18 types of heads from the "Serie Distinzione".



TESTE SERIE DISTINZIONE

Per le chiavi più comuni Silca ha creato una serie di 18 esclusive teste diverse chiamate "Serie Distinzione" per offrire una notevole possibilità di scelta per personalizzare le vostre chiavi. Scegliete le teste che vi piacciono: nelle pagine seguenti troverete tutti gli articoli disponibili con i 18 tipi di teste della "Serie Distinzione".



SCHLÜSSELKÖPFE DER SERIE "DISTINZIONE"

Für die gängigsten Schlüssel hat Silca eine Serie mit 18 verschiedenen Köpfen mit dem Namen "Distinzione" geschaffen, um Ihnen eine beachtliche Auswahl zur Personalisierung Ihrer Schlüssel zur Verfügung zu stellen. Wählen Sie die Köpfe, die Ihnen am besten gefallen. Auf den folgenden Seiten finden Sie alle Artikel, die über die 18 Kopftypen der "Serie Distinzione" verfügen.



TÊTES SÉRIE DISTINCTION

Pour les clés les plus communes, Silca a créé une série de 18 têtes exclusives sous la dénomination «Série Distinction» afin de fournir un vaste choix permettant de personnaliser vos clés. Sélectionnez les têtes qui vous plaisent: les pages suivantes proposent tous les éléments disponibles avec les 18 types de têtes de la «Série Distinction».



CABEZAS SERIE DISTINZIONE

Para las llaves más comunes, Silca ha creado una serie de 18 cabezas diferentes y exclusivas, llamada "Serie Distinzione", que ofrece una amplia variedad de opciones para personalizar las llaves. Elija las cabezas que más le gusten: en las páginas siguientes encontrará todos los artículos disponibles con los 18 tipos de cabeza de la "Serie Distinzione".



CABEÇAS SERIE DISTINZIONE

Para as chaves mais comuns, a Silca criou uma série de 18 cabeças exclusivas diferentes denominadas "Serie Distinzione", oferecendo assim uma maior possibilidade de escolha para personalizar as suas chaves. Escolha o tipo de cabeça preferido: nas páginas seguintes você vai encontrar todos os artigos disponíveis com os 18 tipos de cabeças da "Serie Distinzione".

SERIE DISTINZIONE HEADS - TESTE SERIE DISTINZIONE - SCHLÜSSELKÖPFE DER SERIE "DISTINZIONE" - TÊTES SÉRIE DISTINCTION - CABEZAS SERIE DISTINZIONE - CABEÇAS SERIE DISTINZIONE

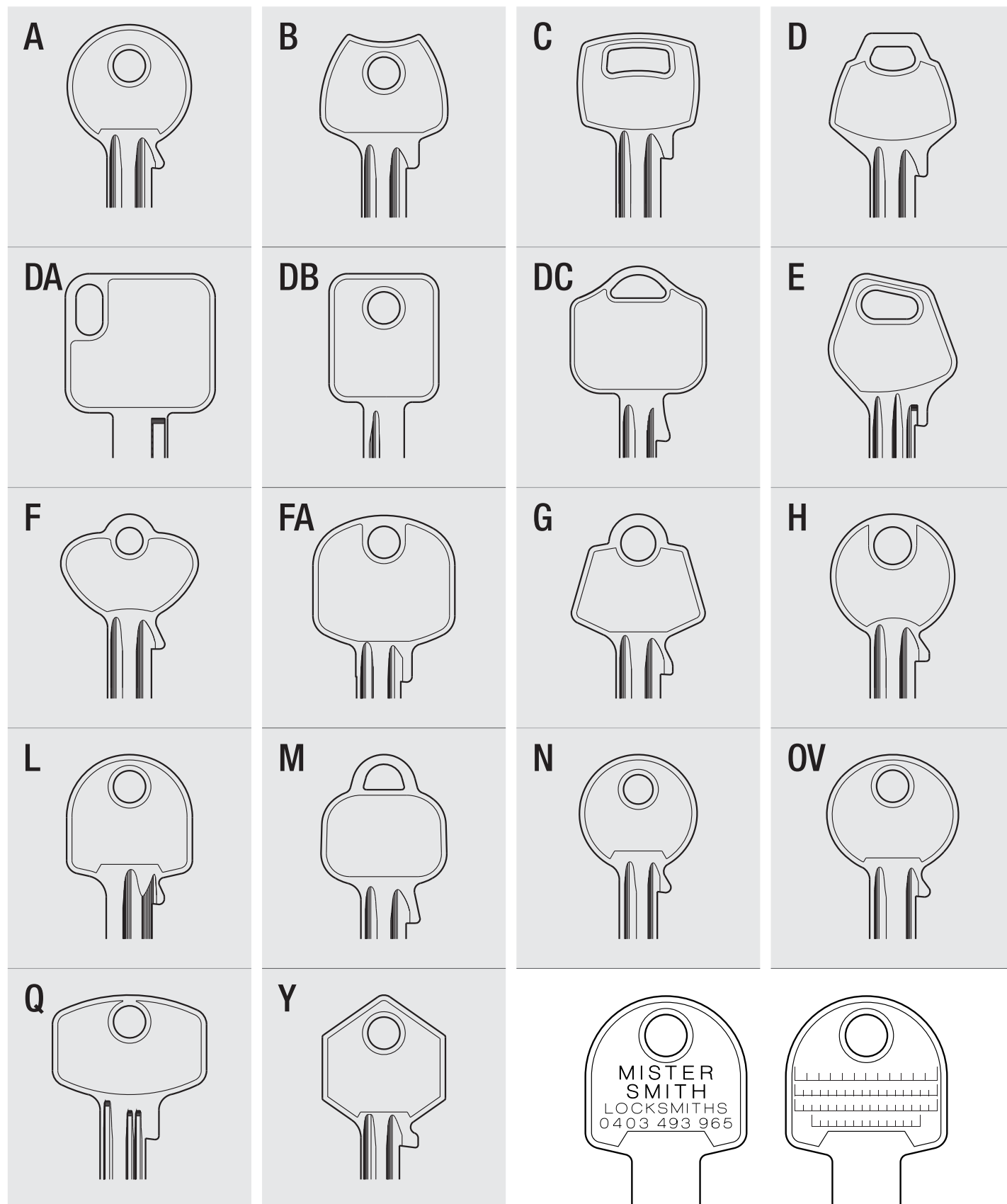

A

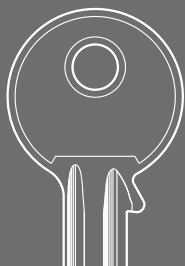

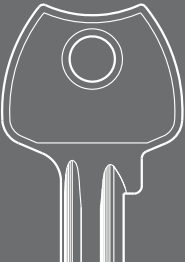
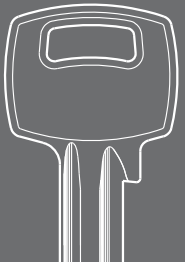

AA1	CB20	FAM1	IE8	LP20R	OA2R	SE7R	UL048	WA6R
AA1R	CB5	FAM1R	IE8R	LP5	OA3R	SI1R	UL049	WE1
AA5	CB6	FAM2R	IL1	LP5R	OL4	SIL1R	UL050	WE14
AA5R	CB78R	FB26	IL1R	LP7	OL5	SN3R	UL051	WE15
AA6	CB83	FB26R	ILS1	LP7R	OL5R	SN4R	UL052	WE16
AA6R	CC1	FEB1	JOW8	LT2	OL6	SO4	UL053	WE16R
AAA1	CEE1	FEB1R	JS1	MG1	OV1	SO7	UL054	WE1R
AB14	CLS242	FEB2	JS1R	MG1R	OV1R	SO8R	UL055	WE2
AB14R	CLS3	FEB2R	JW1	MG2	OV2	SQ4R	UL058	WE2R
AB54	COR1	FF1	JW11	MG2R	OV2R	SS12	UL059	WE5
AG2	CS121	FF1R	JW12	MG3	PC1	STA1	UL062	WE5R
AG2R	CS15R	FF2	JW13	MI1	PC10	STA1R	UL063	WE7
AG3	CS204	FF7	JW1R	MI1R	PC10R	STA2	UM2	WE7R
AG3R	CS205	FF7R	JW2	MI2	PC14	STA2R	UNI3	WMS1
AG4	CS206	FF8	JW2R	MI2R	PC18R	STA3	VAC29	WMS2
AG4R	CS207	FF8R	JW3	MI5	PC19R	STA3R	VI080	WR1
AG7	CS33	FF9	JW4R	MI5R	PC1R	SVN2	VI081	WR2
AG7R	CS33R	FF9R	JW5	MIG1	PC20	TAR4	VI082	YA1
AGB1R	CS38A	FH10R	JW6	MIG2	PC4	TAR4R	VI083	YA226
AKR9R	CS4R	FH13	JW7R	MN1	PC4R	TAR5	VI086	YA31
ALM1	CS68	FH15	JW8	MN2	PF092	TAR5R	VI1	YA31R
ALM1R	CS7	FH18	JW9	MN2R	PF092S	TG1	VI10	YA6
AMC1R	CS70	FH8R	KAK1	MN3	PF18	TL11	VI10R	YAR1
AMC2R	CT1	FM090	KEI1R	MN3R	PF2	TL11R	VI11	YT15
AMC3	CT1R	FM2	KK1	MN4R	PF210	TL13	VI12	ZA2R
AZ2	CT2	GD2	KLE3R	MN7	PF211	TN16	VI13	ZI1
AZ2R	CT2R	G01R	KLE3RX	MN7R	PF2S	TN16X	VI1R	ZI1R
AZ4	CVL1	G02R	KLE3X	MON1	PF7	TN2	VI2	ZI2R
BAI5R	CVL1R	GS7	KLE5RX	MON1R	PF7S	TN39	VI23	ZI4
BAL7	CVL3	GSS1	KLE5X	MP228	PF8	TO26	VI2R	ZI4R
BD2	CVL3R	HDL3	KLE6RX	MP229	PF8R	TP1	VI6	ZI5
BD2R	CVL4	HDL3R	KLE6X	MP230	PG1	TP1R	VI9	ZI5R
BE200	DEA2	HE1	KLE7RX	MP231	PG1R	TP2	VI9R	
BE201	DM32	HE1R	KLE7X	MSF1	PT2	TP2R	VL2	
BE202	DO1R	HE3R	KM1	MTA1R	RIQ9	TR2	VL2R	
BI110	EA1	IB1	KM1R	MTA3R	RIQ9R	TRM2	VL3	
BM1	ECM1	ICS1	LD4	MTA4	RM1A	TS1	VL3R	
BM2	ECM1R	ICS1R	LD4R	MTK5	RM1RA	TS2	WA1	
BR1	EL1	ICS2	LD5R	MTK5R	RM2A	TU1	WA1R	
BS1	ER2	ICS2R	LN1	NF1	RM2RA	UAP2	WA2	
CA10	ER3R	ICS3	LP13	NF1R	RZA3	UL046	WA2R	
CA10R	EVO1	IE6	LP13R	OA2	SE7	UL047	WA6	

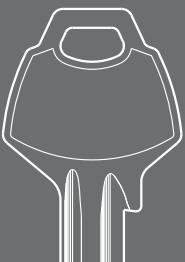
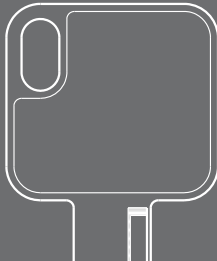
B 	CS204	IE2R	UL053	C 	ADT1	EL1	UL053
	CS205	MG1R	WA1		CS204	IB1	VI080
	CS206	UL050	WA1R		CS205	UL050	VI082
	CS207	UL051			CS206	UL051	WA1R
	EL1	UL052			CS207	UL052	WA2R

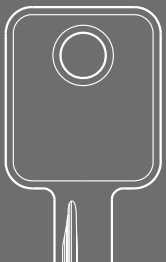
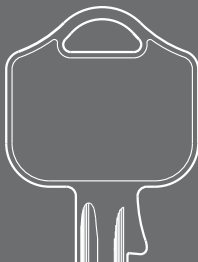
D 	CS204	EL1	UL051	DA 	AB1	CS206	T030R
	CS205	JL2	UL052		BK1	CS207	UL050
	CS206	JL2R	UL053		BK1R	MTA3R	
	CS207	UL050					

DB 	AB3	BUR2R	HW1	DC 	LW4	UL050	UL054
	AB3R	CE4	JU1		MIW14	UL051	
	BA2	CE7	RB2				
	BA2R	CS7	YA8				
	BUR1	DM10	YA8R				
	BUR1R	DM8					
	BUR2	HN1					

E 	AB91	FM1	JL5	VL5	F 	CS204	UL050
	BK26	FM6	PC13	VL5R		CS205	UL051
	CB6	FM7	UL050	WA1		CS206	UL052
	CS204	IB1	UL051	WA1R		EL1	
	CS205	JL3	UL052	WST1			
	CS206	JL3R	UL053	WTR1R			
	CS207	JL4	VI080				
	EL1	JL4R	VL2R				

FA

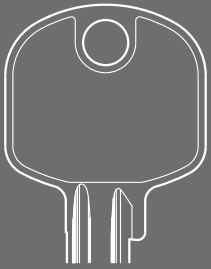

AB1	AB47R	BK1X	CS24	GR3	LT2	TN19R	UL050X	YA1
AB10	BAI1	CA2	DM119	IB1	R024	TN23	UL051	YT15
AB10R	BD3	CE2	DM14	IB1R	R08	TO1	VAC151X	ZE1
AB1R	BD3R	CE2X	DM3	IE6	SI1R	TO1X	VAC2X	ZE1R
AB1RX	BD4R	CS13	DM3X	JM1	STL1R	TOP1R	VAC48X	ZE1X
AB1X	BD9R	CS206	EV10	JM2R	TE2	TOP1RX	WK1	
AB22	BK1	CS207	EV10X	LH42X	TE8X	UL050	WK1X	

G

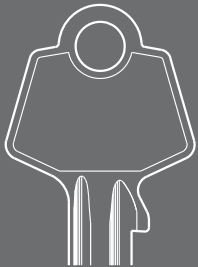

CB6	PF2
CS204	UL050
CS205	UL051
CS206	UL052
CS207	UL053
EL1	

H



CS206	FF3	MN9R	WA7
CS207	FF3R	UL050	WA7R
DS5R	MN8	UL051	
FF10	MN8R	UL052	
FF10R	MN9	UL053	

L

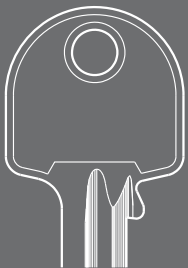

AB1	BAB14	CS205	EL1	FF2	LC2R	PF2	TN16X	UL052X
AB1R	BES1	CS205X	EV10	FH31	LP21	PF212	TN2	UL053
AB1X	BK1	CS206	EV10X	GE1	LP5	PF2S	TO1	UL053SL
AB36	BK1X	CS206X	EV3	GE106	LP5X	RW8R	TO1X	UL053X
AB36R	BK5-16	CS207	EV4	GE106X	LT2	SAR17	TO30RX	UL054
AB54	BK5-6	CS207X	EV69X	HUT1	LT2X	SAR17R	TOP1R	UL054SL
AB63	CB25R	CVL1	EZ2R	IB1	LT4	SAR3	TOP1RX	UL054X
AE2R	CB6	CVL1R	FAC7	IE12	LT4X	SAR3R	TY1	UL055
AG3	CB6X	CVL3	FB13R	IE2	LW4	SH10	UC1	UL055X
AG3R	CE2	CVL3R	FB13RX	IE6	LW4R	SH11	UC1R	UL058SL
AGB1R	CE20	CYS1	FB15RX	ILC2	LW5	SH3	UL050	UL062
AGB2R	CE20X	DM119	FB19R	JOW10	MC12	SH5	UL050SL	UL063
ASEC2	CE2X	DM119X	FB20RX	JS2	MC2	SH7	UL050X	UNI3
AW5	CE41X	DM14	FB21R	KF1	MC2R	SH9	UL051	VAC2
AW7	CS13X	DM3	FB22R	KS1	MER8	SL1	UL051SL	VAR3
AZ2	CS143X	DM3X	FB25R	LC11	MS2	TE2	UL051X	VI080
AZ2R	CS204	DX1	FB28R	LC11R	PF092	TE2X	UL052	VI081
BAB13X	CS204X	EG1	FDR2	LC2	PF092S	TE6	UL052SL	VI082

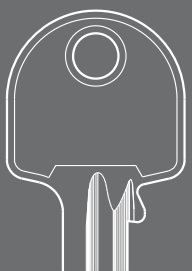
L 	VL2R	WE1	WK1	YA1	YA226X	YA6	ZE1	ZE1X	
	WA1	WE2R	WK1X	YA1E	YA31	YA6X	ZE12X	ZE39RX	
	WA1R	WE1	WMS1	YA1X	YA31X	YT15	ZE1R		
	WA2R	WEI2	WS3	YA226	YA5	YT16	ZE1RX		

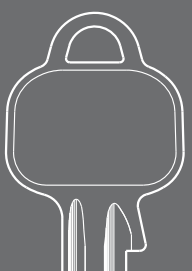
M 	AE1R	CS206	IB1	MIL2	UL051	UL053	VI082	YA226	
	CS204	CS207	KS1	UL050	UL052	VI080	YA1E		

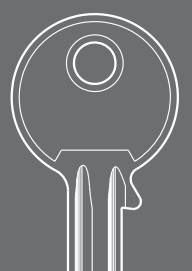
N 	BD17	CB3	FF18	IE3R	MTY2	RGM1R	UL057	WE3	ZI3R
	BSI1	CB85	GL3	JB1	NE34	RX1	UL058	WE3R	
	BSI1R	CC1	GL3R	JL1	OB1	STA8	UL059	WK3	
	BSI2R	CC1R	GL4	JOW4R	OC074	STA8R	UL060	YD4	
	BSI4	CEN2	GL4R	JU1	PA2	TAR3	UL061	YD4R	
	BSI4R	CEN2R	IE1	JU1R	PA2R	TAR3R	VI084	YT13	
	CA1	CS7	IE1R	MN5	PF070	TAR8	VI085	YT13R	
	CA9	FF14	IE28R	MN5R	PF9	TRE2	VI086	YT7	
	CB15	FF17	IE3	MTY1	RGM1	UL056	VI087	YT7R	

OV 	AB1	AB33	AB70X	ASS186	BK1	BK27	BK3-3	BK5-1	BK5-16
	AB10	AB4	AB79RX	AZ5	BK13	BK2R	BK3-4	BK5-10	BK5-17
	AB10R	AB5	AB8	BAB31	BK1R	BK3-1	BK3-5	BK5-11	BK5-18
	AB1R	AB55X	AB8R	BAI23	BK1X	BK3-10	BK3-6	BK5-12	BK5-19
	AB1RX	AB6	AL1	BAL1	BK21R	BK3-11	BK3-7	BK5-13	BK5-2
	AB1X	AB68X	AL1R	BAL1R	BK22R	BK3-12	BK3-8	BK5-14	BK5-20
	AB21R	AB69X	ARE1	BG1	BK23R	BK3-2	BK3-9	BK5-15	BK5-21

OV



BK5-22	BK6-3	CO1	EV69X	JOW12RX	LYG6	STU1	T054-7	T09RY1
BK5-23	BK6-30	CO1R	FAM6	JOW12X	LYH	SV3	T054-8	T09RY10
BK5-24	BK6-31	COR1	FB35R	JOW1R	LYH6	SV3R	T06	T09RY11
BK5-25	BK6-32	CS13X	FH16R	KF1	LYK	SV7	T07	T09RY12
BK5-26	BK6-33	CS206	FH30	KFA	LYK6	TN16X	T075R	T09RY13
BK5-27	BK6-34	CS206X	FS1	KFB	LYP5B	TN42	T081R	T09RY14
BK5-28	BK6-35	CS207	FS1R	KFC	LYP6A	TN42R	T082R	T09RY15
BK5-29	BK6-4	CS31R	FV1	KFD	LYP6D	T01	T08RX1	T09RY16
BK5-3	BK6-5	CS52X	GD8	KFE	MEG2	T0108X	T08RX10	T09RY17
BK5-30	BK6-6	DF3	GD8R	KFF	MIL1	T015	T08RX11	T09RY18
BK5-31	BK6-7	DF3R	GE1	KFG	ORA2	T016	T08RX12	T09RY2
BK5-32	BK6-8	DM105R	GOD4R	KFH	RG1	T017	T08RX13	T09RY3
BK5-33	BK6-9	DM11	GR1R	KFI	RO8	T01X	T08RX14	T09RY4
BK5-34	BK7R-1	DM119	GR9-5	KFJ	RU1	T02	T08RX15	T09RY5
BK5-35	BK7R-10	DM119X	GR9-7	KFK	RU10R	T025R	T08RX16	T09RY6
BK5-4	BK7R-2	DM123-1	GR9-8	KFL	RU11R	T028R	T08RX17	T09RY7
BK5-5	BK7R-3	DM123-	GR9-9	KFM	RU12	T029X	T08RX18	T09RY8
BK5-6	BK7R-4	10	GR9R-1	KFN	RU13	T03	T08RX2	T09RY9
BK5-7	BK7R-5	DM123-2	GR9R-3	KFO	RU16	T030	T08RX3	T09Y1
BK5-8	BK7R-6	DM123-3	GV7	KFR	RU19	T030R	T08RX4	T09Y10
BK5-9	BK7R-7	DM123-4	GVA	KFS	RU1R	T030RX	T08RX5	T09Y11
BK6-1	BK7R-8	DM123-6	GVA6	KFU	RU2	T030X	T08RX6	T09Y12
BK6-10	BK7R-9	DM123-7	GYB	KFW	RU20	T031R	T08RX7	T09Y13
BK6-11	BLA1	DM123-8	GYB6	KFX	RU21	T034	T08RX8	T09Y14
BK6-12	BLA2	DM123-9	GYC	LC11R	RU22R	T039R	T08RX9	T09Y15
BK6-13	BLA3	DM25	GYC6	LH4	RU23R	T04	T08X1	T09Y16
BK6-14	BRT1	DM28	GVD	LH42	RU28	T05	T08X10	T09Y17
BK6-15	BVA1	DM3	GVD6	LP21	RU2R	T054-1	T08X11	T09Y18
BK6-16	BVA1R	DM35R	GVE6	LP5	RU3	T054-13	T08X12	T09Y2
BK6-17	BY1	DM3X	GYF	LW24	RU3R	T054-14	T08X13	T09Y3
BK6-18	C1	DM48	GYF6	LYA	RU4R	T054-16	T08X14	T09Y4
BK6-19	C1R	DM7	GYG	LYA6	RU5	T054-17	T08X15	T09Y5
BK6-2	CB6	DO6	GYG6	LYB	RU5R	T054-18	T08X16	T09Y6
BK6-20	CB6X	EM11	GYH	LYB6	RU6	T054-19	T08X17	T09Y7
BK6-21	CE1	ER1	GYH6	LYC	RU7	T054-2	T08X18	T09Y8
BK6-22	CE17WPS	ERT1	GYK	LYC6	RU8R	T054-20	T08X2	T09Y9
BK6-23	CE1R	ET1	GYK6	LYD	RU9R	T054-21	T08X3	TOP1RX
BK6-24	CE2	ET1R	GYP5A	LYD6	SAN1	T054-23	T08X4	TR15
BK6-25	CE20	ET2R	GYP5B	LYE	SAN1R	T054-24	T08X5	TU2
BK6-26	CE2R	EV10	GYP5D	LYE6	SEI10	T054-3	T08X6	UL050
BK6-27	CE2X	EV10X	GYP6B	LYF	SHW1	T054-4	T08X7	UL050X
BK6-28	CE41X	EV2	HT2	LYF6	ST1	T054-5	T08X8	UL051
BK6-29	CE5	EV3	JOW1	LYG	STL1RX	T054-6	T08X9	UL051X

OV



UNI28	VYF	WK15	WK2R	WK44R	WSD1	YYA	YYK	ZE1X
UP1	VYF6	WK16	WK30	WK45R	WSD1R	YYA6	YYK6	ZE2
VAC151	VYG	WK17R	WK31	WK45X	YA1	YYB	YYP6A	ZE34
VAC30	VYG6	WK18	WK32	WK46	YA27R	YYB6	YYP6B	ZE34R
VAC30R	VYH	WK19	WK33	WK47R	YA31	YYC	YYP6D	ZE34RX
VG1	VYH6	WK1X	WK34	WK48	YA5	YYC6	ZE1	ZE34X
VYA	VYK	WK2	WK35	WK5	YA67	YYD	ZE10	ZE39
VYA6	VYK6	WK20	WK36	WK52R	YA70	YYD6	ZE10R	ZE39RX
VYB	VYP6B	WK21	WK37	WK53R	YA70R	YYE	ZE12	ZE39X
VYB6	VYP6D	WK22	WK38	WK54R	YA71	YYE6	ZE12X	ZE40X
VYC	WK1	WK25	WK39	WK56R	YA71R	YYF	ZE13	
VYC6	WK10	WK25R	WK4	WK6	YA72	YYF6	ZE13R	
VYD	WK11	WK26	WK40	WK6R	YA72R	YYG	ZE15	
VYD6	WK12	WK27	WK41R	WK7	YA84	YYG6	ZE16	
VYE	WK13	WK28	WK42R	WK71X	YA84R	YYH	ZE1R	
VYE6	WK14	WK29	WK43R	WK9	YA9	YYH6	ZE1RX	

Q

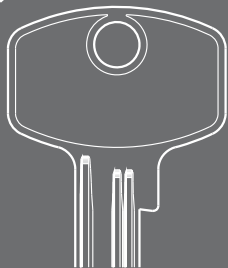

AB1	DM12-13	DM12-00	DM12-29	DM12-6	DM29	DM65-12	DM65-32	DM65R-19
AB1R	DM12-14	DM12-1	DM12-3	DM12-7	DM29R	DM65-13	DM65-33	DM65R-31
BK1	DM12-15	DM12-10	DM12-30	DM12-8	DM3	DM65-14	DM65-34	DM65R-32
CA11	DM12-16	DM12-11	DM12-31	DM12-9	DM33R	DM65-15	DM65-35	DM65R-34
CA2	DM12-17	DM12-12	DM12-32	DM12R-00	DM40	DM65-16	DM65-36	DM65R-35
CA8	AB1	DM12-13	DM12-33	DM12R-12	DM40R	DM65-17	DM65-4	DM65R-36
CB6	AB1R	DM12-14	DM12-34	DM12R-13	DM42	DM65-18	DM65-40	DM66
CE2	BK1	DM12-15	DM12-35	DM12R-16	DM42R	DM65-19	DM65-41	DM66R
CS206	CA11	DM12-16	DM12-36	DM12R-19	DM43	DM65-2	DM65-42	DM67
DM103	CA2	DM12-17	DM12-37	DM12R-31	DM43R	DM65-20	DM65-43	DM67R
DM108	CA8	DM12-18	DM12-38	DM12R-32	DM44	DM65-21	DM65-44	DM68
DM108R	CB6	DM12-19	DM12-39	DM12R-34	DM44R	DM65-22	DM65-45	DM68R
DM109	CE2	DM12-2	DM12-4	DM12R-35	DM45	DM65-23	DM65-46	DM69
DM109R	CS206	DM12-20	DM12-40	DM12R-36	DM46R	DM65-24	DM65-5	DM69R
DM115	DM103	DM12-21	DM12-41	DM14	DM47	DM65-25	DM65-6	DM70
DM115R	DM108	DM12-22	DM12-42	DM141R	DM47R	DM65-26	DM65-7	DM70R
DM119	DM108R	DM12-23	DM12-43	DM150	DM50	DM65-27	DM65-8	DM71
DM12-00	DM109	DM12-24	DM12-44	DM18	DM60	DM65-28	DM65-9	DM71R
DM12-1	DM109R	DM12-25	DM12-45	DM18R	DM65-00	DM65-29	DM65R-00	DM72
DM12-10	DM115	DM12-26	DM12-46	DM20	DM65-1	DM65-3	DM65R-12	DM72R
DM12-11	DM115R	DM12-27	DM12-47	DM26	DM65-10	DM65-30	DM65R-13	DM73
DM12-12	DM119	DM12-28	DM12-5	DM26R	DM65-11	DM65-31	DM65R-16	DM73R

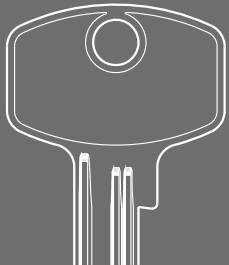
Q 	DM74	DM78	DM82	DM85R	DM89	DM93R	LT2	UL051	ZE1R
	DM74R	DM78R	DM82R	DM86	DM90	DM94R	RIQ1R	VAC2	
	DM75	DM79	DM83	DM86R	DM91	DM95	R08	VI080	
	DM75R	DM79R	DM83R	DM87	DM91R	DM95R	TE2	VI15R	
	DM76	DM80	DM84	DM87R	DM92	DM97R	TO1	VI16R	
	DM77	DM81	DM84R	DM88	DM92R	IB1	TOP1R	WK1	
	DM77R	DM81R	DM85	DM88R	DM93	LEA1	UL050	YA1	

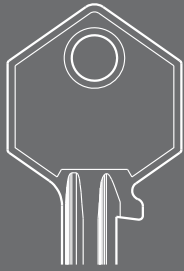
Y 	EL1	UL051	YA227	YA42	YA46	YA50	YA54	YA58	YA61
	JH1	UL054	YA31	YA43	YA47	YA51	YA55	YA59	YA62
	PC11	VAL1	YA31R	YA44	YA48	YA52	YA56	YA6	YA63
	UL050	YA226	YA41	YA45	YA49	YA53	YA57	YA60	YA6R



Household Keys
Chiavi Piatte
Flachschlüssel
Clés plates
Llaves Planas
Chaves Planas

PER:
FOR:

3F

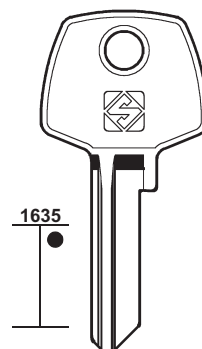
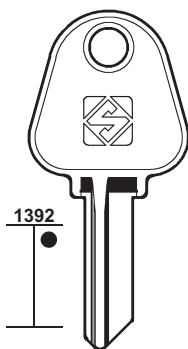
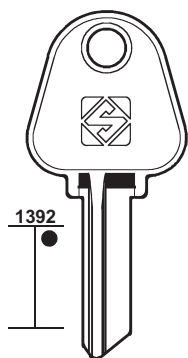
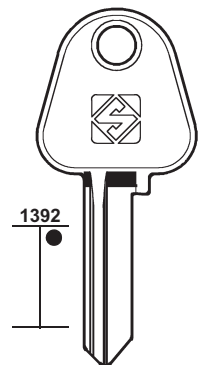

3

PER / FOR

3F (BR)

3M (PRC)

333 (IL)
+ CORNI (55)

555 (RC)
+ CINA (48)

606 (RA)

PER:
FOR:

3F

3M

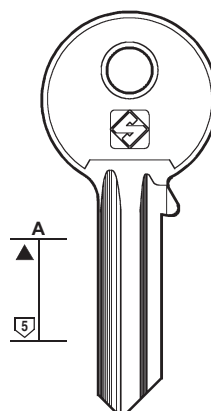
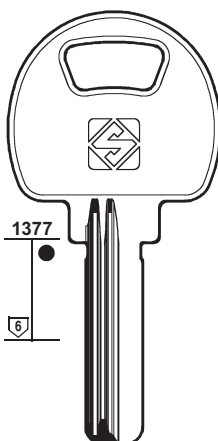
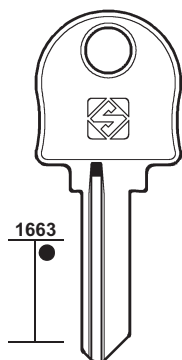
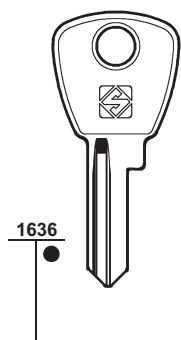

PER:
FOR:

333

606

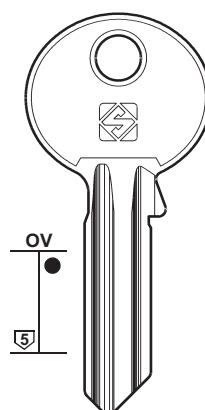
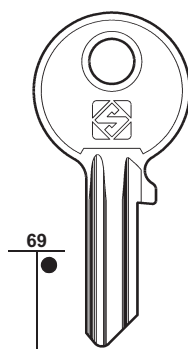
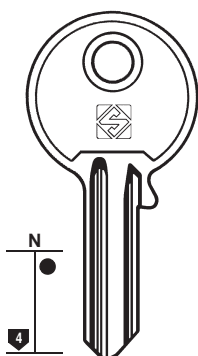
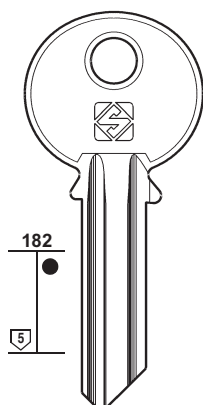



4

PER / FOR

aaa (IL)

ABA (GR)

ABBES (GB)

LAS (111)

ABC (E)

BAGEM

ABLOY (FIN)

KITTY

VIRO

PER:
FOR: aaa

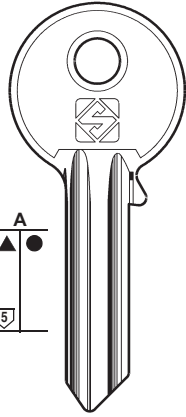

AAA1

ABA

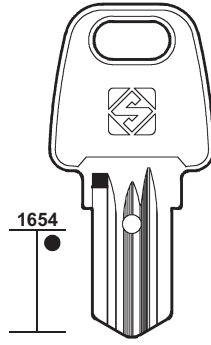

AAB1

ABC

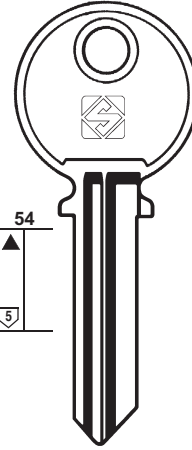

AC1

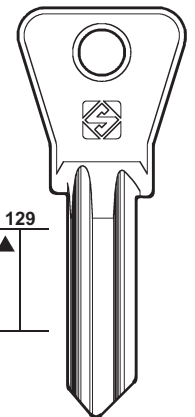

AC2

BAGEM

PER:
FOR:

ABLOY

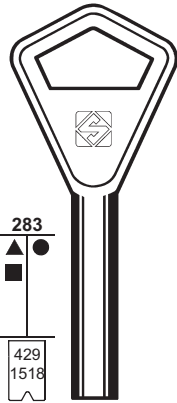

AY1

..... (DX)
..... (SX)
0-1-2-3-4-5-6-7-8-9

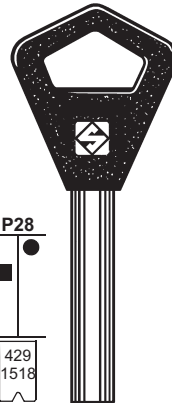

AY1P

..... (DX)
..... (SX)
0-1-2-3-4-5-6-7-8-9



KITTY - VIRO

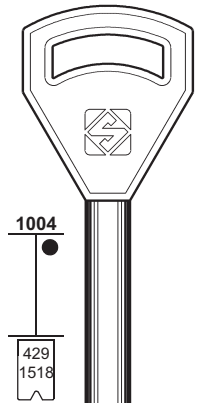

AY11

PER:
FOR:

ABLOY

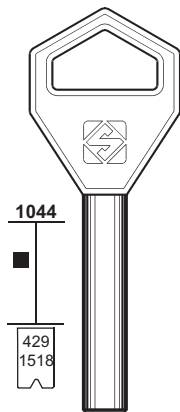

AY12

..... (DX)
..... (SX)
0-1-2-3-4-5-6-7-8-9

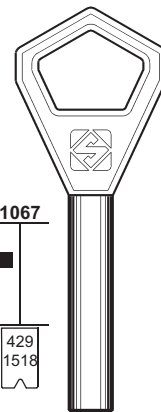

AY16

..... (DX)
..... (SX)
0-1-2-3-4-5-6-7-8-9

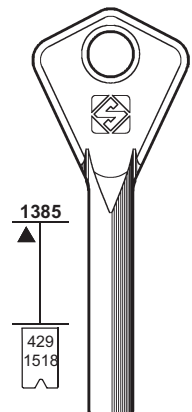

AY30

..... (DX)
..... (SX)
0-1-2-3-4-5-6-7-8-9



PER:
FOR:

ABLOY

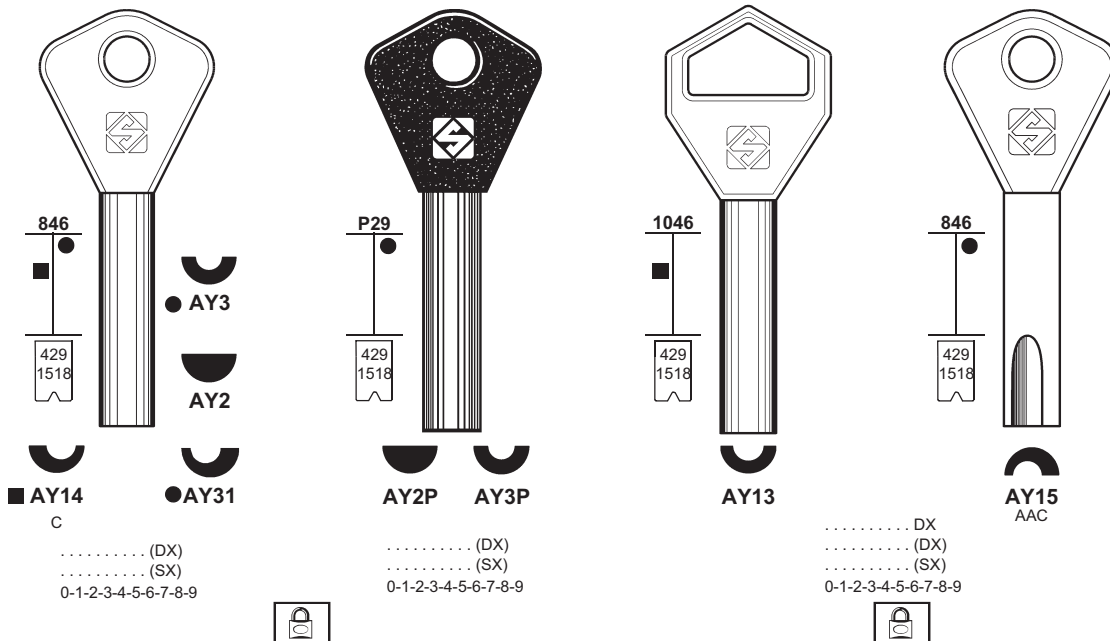

5

PER / FOR
ABLOY (FIN)

PER:
FOR:

ABLOY

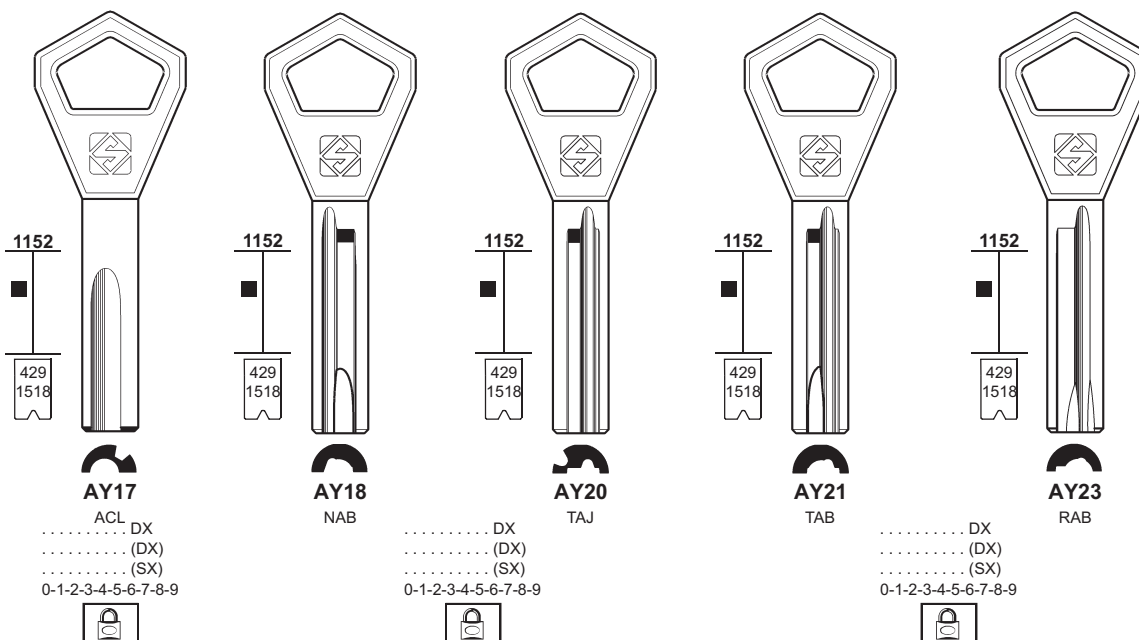

PER:
FOR:

ABLOY

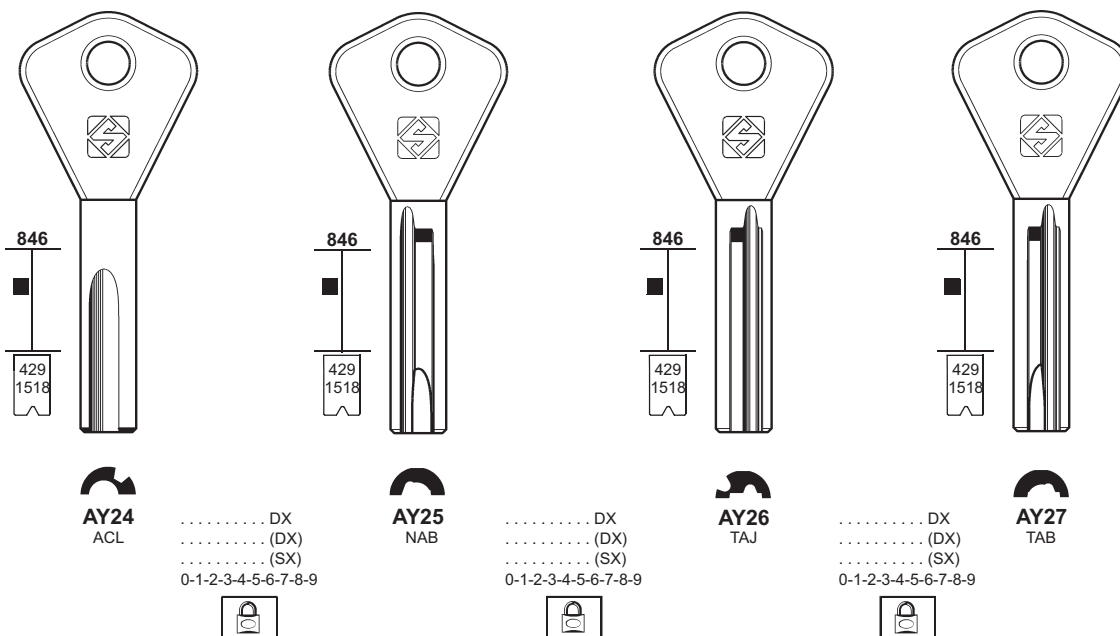



6

PER / FOR

ABLOY (FIN)

ABT (I)

+ VIRO (187)

ABUS (D)

CISA

JPM

OTHMER

TOP

+ G.R. (90)

+ GUARD (90-91)

+ PFAFFENHAIN (141)

+ YALE (194)

PER:
FOR:

ABLOY

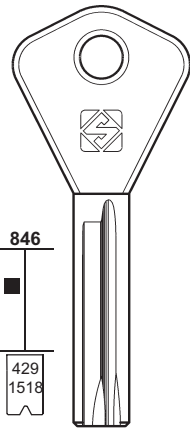

846
429
1518



AY28
RAB

..... DX
..... (DX)
..... (SX)
0-1-2-3-4-5-6-7-8-9

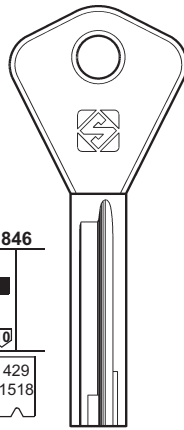

846
429
1518



AY29
RAG

..... (DX)
..... (SX)
0-1-2-3-4-5-6-7-8-9

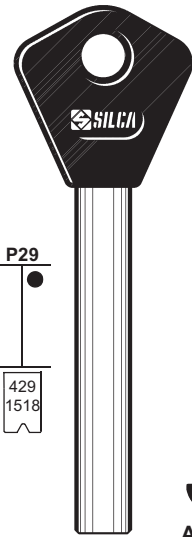

P29
429
1518



AY10P



PER:
FOR:

ABUS

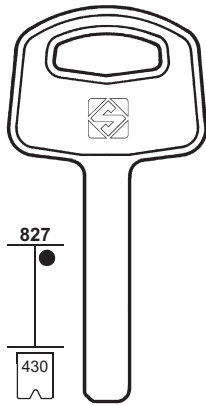

827
430

AB32
.....
1-2-3-4-5-6

GRANIT

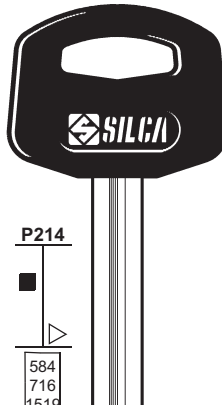

P214
584
716
1519

AB38P
.....
1-2-3-4-5-6

ABUS PLUS

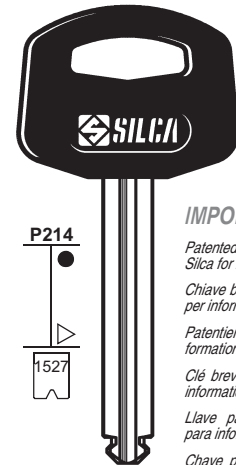

P214
1527

AB60P
.....
1-2-3-4-5-6

IMPORTANT!

Patented key, please contact Silca for information.

Chiave brevettata, rivolgersi a Silca per informazioni.

Patentierter Schlüssel. Bitte, für Informationen an Silca sich wenden.

Clé brevetée, contacter Silca pour information.

Llave patentada, contactar Silca para informaciones.

Chave patenteada, por favor contacte Silca para informação.

PER:
FOR:

ABUS

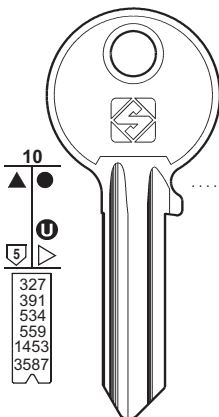

10
327
391
534
559
1453
3587

AB1R
.....
1-2-3-4-5-6

AB1
.....
1-2-3-4-5-6

BJ 1-20728
..... 1-2-3-4-5-6-7-8-9
C42
1-2-3-4-5-6-7-8-9
P
00000-02360

AY 1-6032
BA 1-6032
BB 1-6032
BC 1-6032
BD 1-6032
BK 1-6032
BL 1-6032
BM 1-6032
BN 1-6032
BP 1-6032
BQ 1-6032
BR 1-6032
BS 1-6032
BT 1-6032
BU 1-6032
BY 1-6032
SA 1-6032
SB 1-6032

AB10R
F3
BCISS 1-6032
F2D 1-6032

AB10
F3
..... AA 000-999
..... AB 000-999
..... AF 001-954
..... AM 001-988
..... AN 001-958
..... AV 001-999
..... BB 001-636
..... BK 001-997
..... BL 001-998
..... BM 002-999
..... BP 001-331
..... BQ 001-398
..... BR 001-397
..... BT 000-999
..... BU 000-999
..... BV 000-999
..... GF 001-892
..... GG 001-879
..... GH 001-359
..... GJ 001-358
..... GK 001-308
..... GM 001-999
BCISS 1-6032
F2C 1-6032

AB8

AB21
X4D

AB22

AB78R

AB33

AB26
OTHMER
B09

AB8R

AB21R
X4S

AB25R

AB47R

AB34
B49

AB36

AB37

AB44

AB42R

AB75

AB36R

AB37R

AB44R

AB42R

AB67

JM1
F3

AY-BA
BB-BC
BD-DK
BL-BM
BN-BP
BQ-BR
BS-BT
BU-BY
SA-SB
F3C
..... 1-6032

TOP1R
TOP

JM1R
F3
F3D 1-6032

JM2

JM2R

CISA - JPM - OTHMER - TOP

PER:
FOR:

ABUS

Key 1: Dimensions OV, 5. Bit patterns: AB79RX, AB70X, AB69X, AB68X, AB1X, AB1RX, AB55X. Brand: BRICARD.

Key 2: Dimension 1329, 5. Bit patterns: AB86, AB61, AB83, AB72 K1S, AB72R K1D.

Key 3: Dimension OV, 5. Bit patterns: AB4 003, AB5 001, AB6 004. Brand: GEGE.

Key 4: Dimension 54, 5. Bit pattern: AB7.



7

PER / FOR

ABUS (D)

- ANCHOR
- BRICARD
- BUFFO
- CISA
- GEGE
- JET
- JPM
- KALE
- + G.R. (90)
- + GUARD (90-91)
- + PFAFFENHAIN (141)
- + YALE (194)

PER:
FOR:

ABUS

Key 1: Dimensions A, 759, 5. Bit patterns: AB14, AB14R. Code: 1-2-3-4-5. Brand: ANCHOR - JET - JPM - KALE.

Key 2: Dimensions 255, 6. Bit pattern: AB9.

Key 3: Dimensions 595, 714, 5. Bit pattern: AB19. Code: 1-2-3-4-5-6.

Key 4: Dimensions 11, 326, 568, 3588, 5. Bit patterns: AB3, AB3R. Code: 1-2-3-4-5-6. A: 1-01321. Brand: CISA.

PER:
FOR:

ABUS

Key 1: Dimensions 11, 326, 500, 4. Bit pattern: AB2. Code: ... 1-342. Bit pattern: AB2R. Code: EE ... 1-800.

Key 2: Dimensions 11, 4. Bit pattern: AB18.

Key 3: Dimensions 167, 4. Bit patterns: AB11, AB11R.

Key 4: Dimensions 2, 5. Bit pattern: AB20. Brand: BUFFO - CISA.

Additional codes for AB2: 1-2-3-4-5-6, B ... 1-342, E ... 801-1236, EF ... 1-724, ER ... 801-1236.



8

PER / FOR

ABUS (D)

- ANCHOR
- ARMSTRONG
- BASI
- BURG
- CISA
- FTH
- GUARD
- GUITTEL
- IMP
- MASTER
- ROYAL

- + G.R. (90)
- + GUARD (90-91)
- + PFAFFENHAIN (141)
- + YALE (194)

PER:
FOR:

ABUS

AB17 AB17R
... 1-2000
... 1-2-3-4-5

AB13 AB13R ▲
... 1-2-3-4-5
FTH

AB29R

AB12 AB12R
... 1-2-3-4-5

AB16 AB16R
... 1-200
... 1-2-3-4-5

AB15 AB15R
... 1-60
... 1-60
... 1-2-3-4-5 1-2-3-4-5

AB23
... 1-24
... 65/25 1-2-3-4-5

AB23R

ANCHOR - IMP

ANCHOR - BURG
GUITTEL - IMP - ROYAL

CISA

BASI - GUARD

PER:
FOR:

ABUS

AB81

AB27
... 1-2-3-4-5-6
mm 50-60

AB30 AB30R

AB31

PER:
FOR:

ABUS

AB35 AB35R

AB39 AB39R

AB41R

AB43 AB43R

AB45

MASTER

ARMSTRONG

PER:
FOR:

ABUS

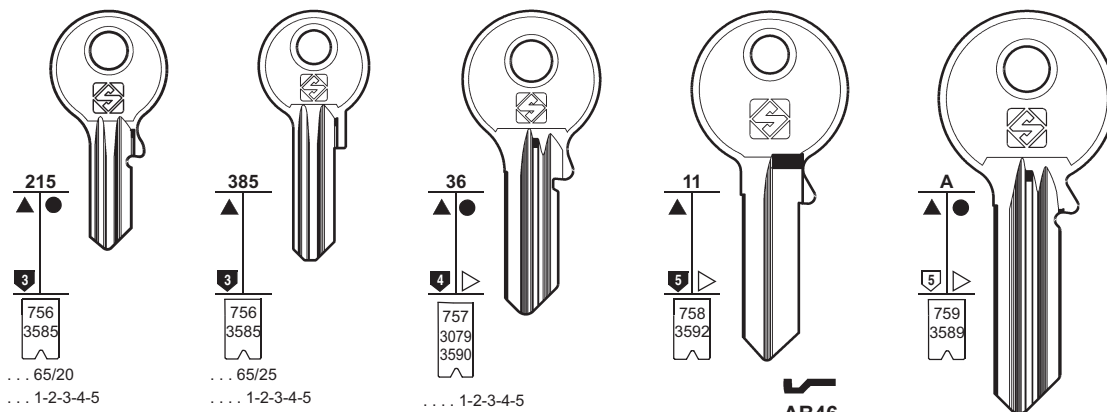

AB50

AB51

AB53

AB52
..... 1-2-3-4-5
..... 1-2-3-4-5-6

AB71

AB54
..... 1-2-3-4-5



9

PER / FOR

- ABUS (D)**
BUFFO
FORT
SECURITAL
 + G.R. (90)
 + GUARD (90-91)
 + PFAFFENHAIN (141)
 + YALE (194)

PER:
FOR:

ABUS

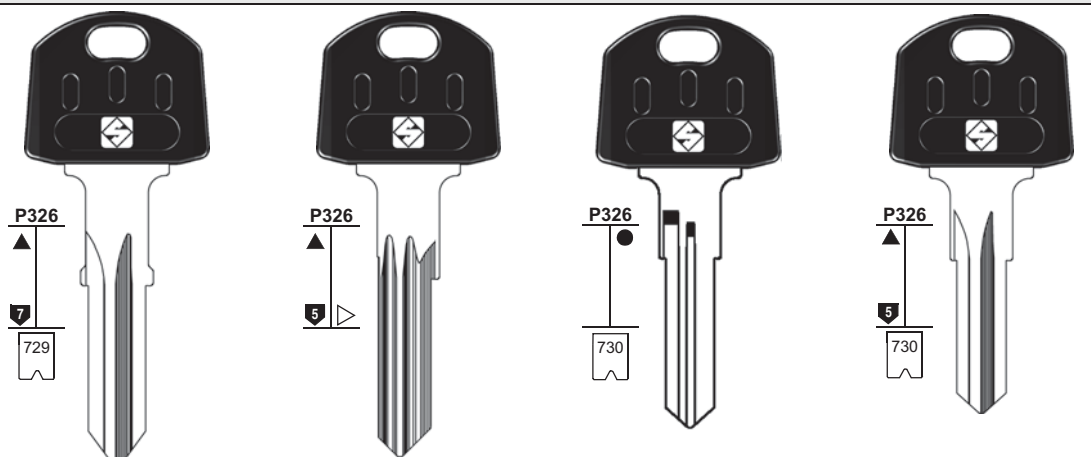

AB57AP **AB57RAP**
Z71 ... 1-1043 Z71 ... 1-1043
Z72 ... 1-1043 Z72 ... 1-1043

AB56AP
SL ...
1-2515

U72 **AB64RAP**
F82 V62 ... 1-331
X61 ... 1-331
X62 ... 1-331

AB65RAP W71

AB58RAP **AB59RAP**
X61 ... 1-331 V61 ... 1-331
X62 ... 1-331
V62 ... 1-331



BUFFO



PER:
FOR:

ABUS

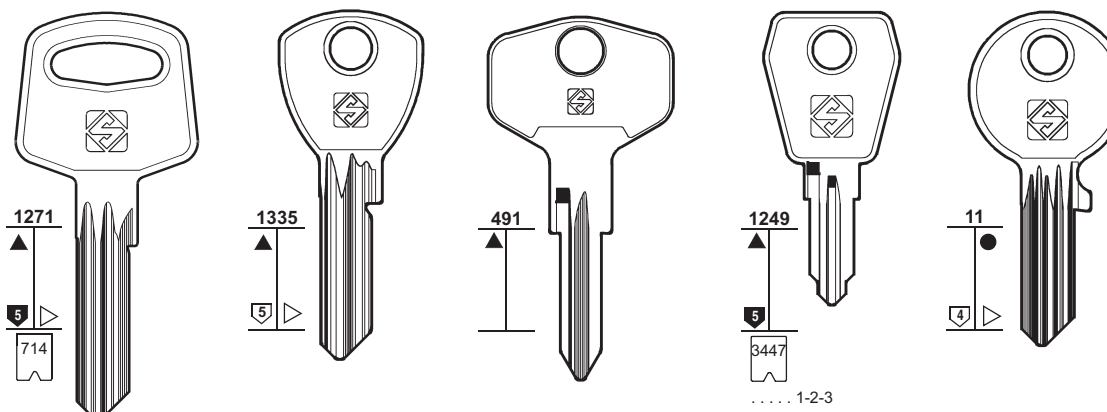

AB56 **AB56R**
SR ... SL ...
1-2515 1-2515

AB76 **AB76R**

AB93R

AB90R
FG

AB85
AL



FORT - SECURITAL



10

PER / FOR

ABUS (D)
 CISA
 BRICARD
 + G.R. (90)
 + GUARD (90-91)
 + PFAFFENHAIN (141)
 + YALE (194)

ACE (USA)
 CHICAGO (46)

ADAMS RITE (USA)

ADEMCO (USA)
 CHICAGO (46)

ADS (D)

AEP (LV)

AGA (E)
 ARREGUI
 BTV
 MECALUX
 SUYOKA
 + CHICAGO (46)

PER:
FOR:

ABUS

AB66R
 48/49
 1205-9533
 1717-9020

AB91

AB74
 D6
 00001-38832
 0001-4800
 (XN005710)1-38832
 000001-168000

AB84
 EC550
 SM
 00001-30000

AB77
 D8

AB48
 D6
 00001-38832
 0001-4800
 (XN005710)1-38832
 000001-168000

NEW ASTRAL

PER:
FOR:

ABUS

ADAMS RITE

ADS

AB40
 AAL
 EXTRA-CLASSE
 00001-50252

AB62
 EC75
 00001-10000
 D8 0001-8000

ADT1

AD1

AD2

CISA - BRICARD

mm 30-40-50

PER:
FOR:

AEP

AGA

AEP1

AEP2

AGA1
 B... 901-926

AGA1R
 A... 901-926

AGA2
 D... 901-926

AGA2R
 C... 901-926

AGA4
 G... 501-526
 G... 901-926

AGA4R
 H... 501-526
 H... 901-926

AGA5
 E... 501-526
 E... 901-926

AGA5R
 F... 501-526
 F... 901-926

AGA3

AGA25

AGA25R

BTV - MECALUX SUYOKA

ARREGUI

PER:
FOR:

AGA

54
477
1197
1197

S177
S842
S897
S898
S971
S972
S971
S1020

S841
S895
S896

AGA6 AGA8 AGA7 AGA9

GARI COLOMENCA - FB CASAS

SERRALLER - TERCA

AGB

599

U C

583

AGB1 AGB1R

SAVIO

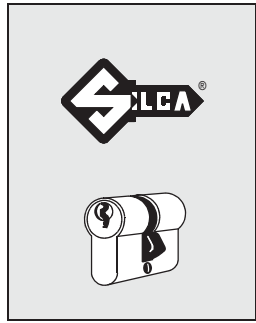

11

PER / FOR

AGA (E)
CASAS
COLOMENCA
FB
GARI
SERRALLER
TERCA
+ CHICAGO (46)

PER:
FOR:

AGB

599
600
600
1275

U

4

5

4

5

S171
S534

..... 0/9
..... A/Z

AGB2 AGB2R AGB3 AGB3R AGB4 AGB5

SAVIO SAVIO SCUDO 9000

AGB (I)
SAVIO

PER:
FOR:

AGB

1434
1434
1434
1434

C

7

S633

6

S647
S1330
S1409
S1440

7

S633

6

S647
S1330
S1409
S1440

..... 0/9
..... A/Z

AGB8 AGB9 AGB6 AGB7

SCUDO 7000 SCUDO 5000

SCUDO



12

PER / FOR

AGE (J)

AGENT (J)

AGUIA (P)

AISPUTE (LV)
KURZEMES

AKIRA (I)

YETI (198-199)

AKKA (I)

WALLY (188)

PER:
FOR:

AGE

AGENT

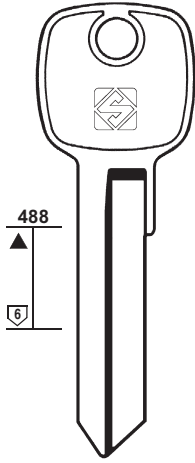

AGE5R

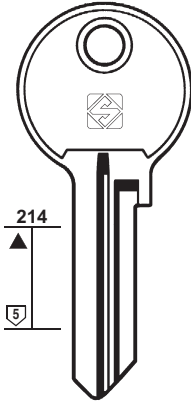

AGE2

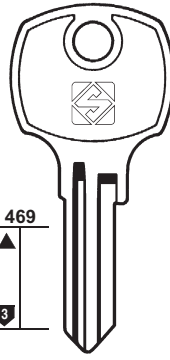

AGE3

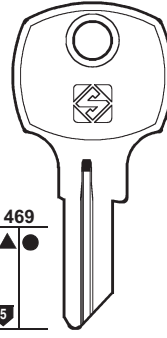

AGE1 ▲ AGE1R

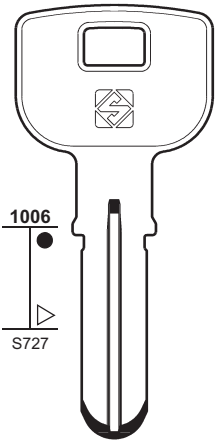

AGN1



PER:
FOR:

AGUIA

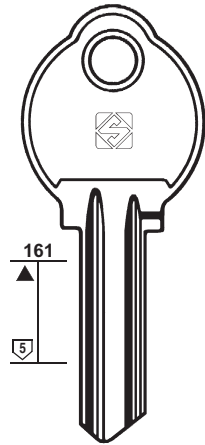

AG1 AG1R

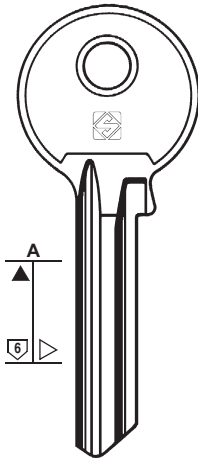

AG4 AG4R

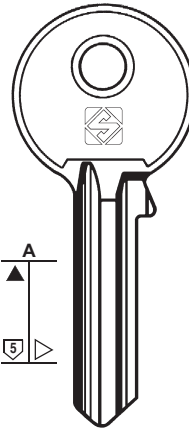

AG2 AG2R

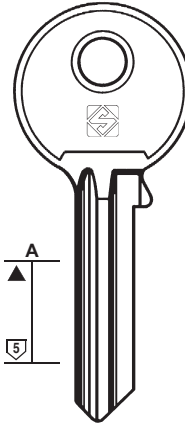

AG3 AG3R

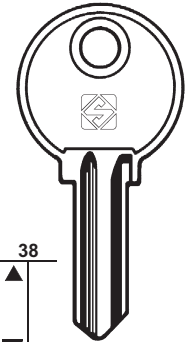

AG5 AG5R

AG7

AG7R

AG6

AG6R

PER:
FOR:

AGUIA

AISPUTE

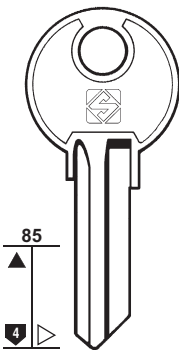

AG8 AG8R

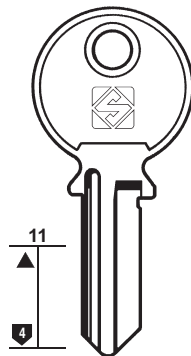

AG9 AG9R

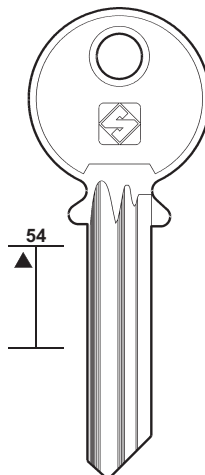

AG10

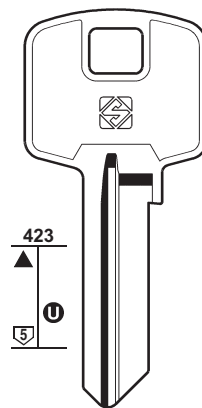

ASU1R

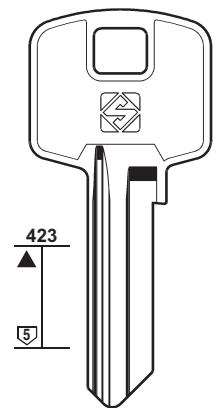

ASU2

KURZEMES

PER: FOR:	AL	AL AHRAM	ALA	
	 ● AL1 ▲ AL1R	 AHR2 	 AA6 ● AA6R mm 70	 AA5 ● AA5R mm 60

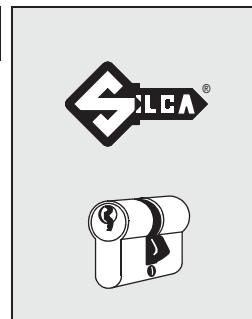

13

PER / FOR
AL (P)
AL AHRAM (ET)
ALA (I)
 CISA
 + CISA (50)
 + KESO (105)
ALDRIDGE E. (GB)
 ASEC SECURITY

PER: FOR:	ALA				
	 AA1 AA1R mm 50	 AA2 AA2R mm 40	 AA3 ... 1-2-3-4-5-6-7 mm 30	 AA4 AA4R CISA mm 15	 CS12 CISA mm 15

PER: FOR:	ALDRIDGE E.		
	 AE1R 	 AE2R 	 ASEC1 ... 1-2-3-4-5-6 ASEC SECURITY



14

PER / FOR

ALDRIDGE E. (GB)
ASEC SECURITY

ALF (F)
CISA (48)

ALFA (S)

ALI (RC)
CINA (48)

ALIANÇA (BR)

ALKE (I)

ALLGOOD (GB)
CENTURY (41)

ALMET (USA)
ARROW (18)

ALPHA (I)
+ CHICAGO (46)

PER: ALDRIDGE E.
FOR:

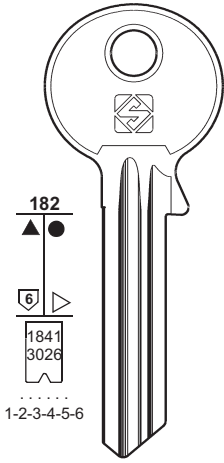

ASEC2

ASEC SECURITY

ALFA

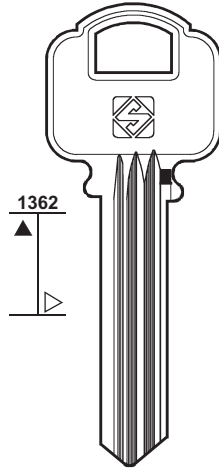

ALA1R



ALA2R

ALIANÇA

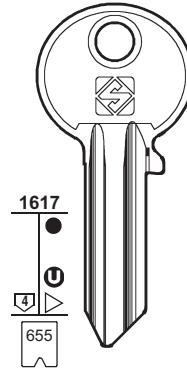

AI1

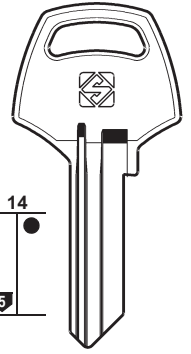

AI2

PER: ALKE
FOR:

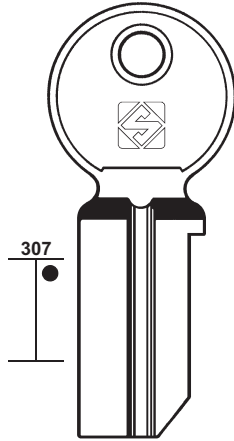

ALK1

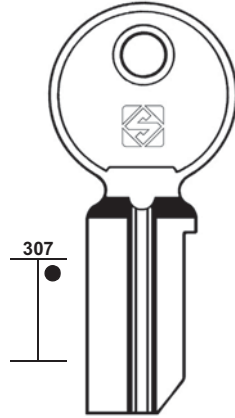

ALK2



ALPHA

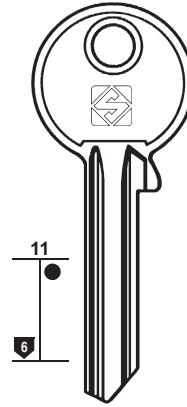

ALP2

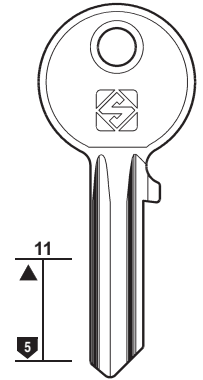

ALP11

PER: ALPHA
FOR:

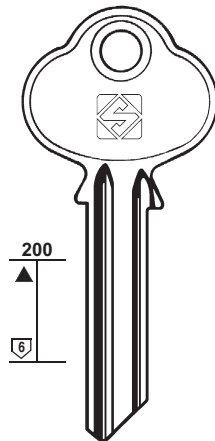

ALP3

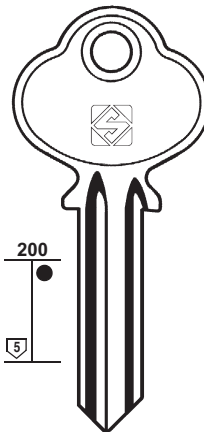

ALP10

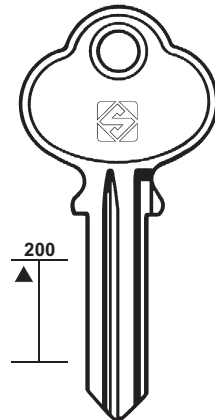

ALP1

PER:
FOR:

ALPHA

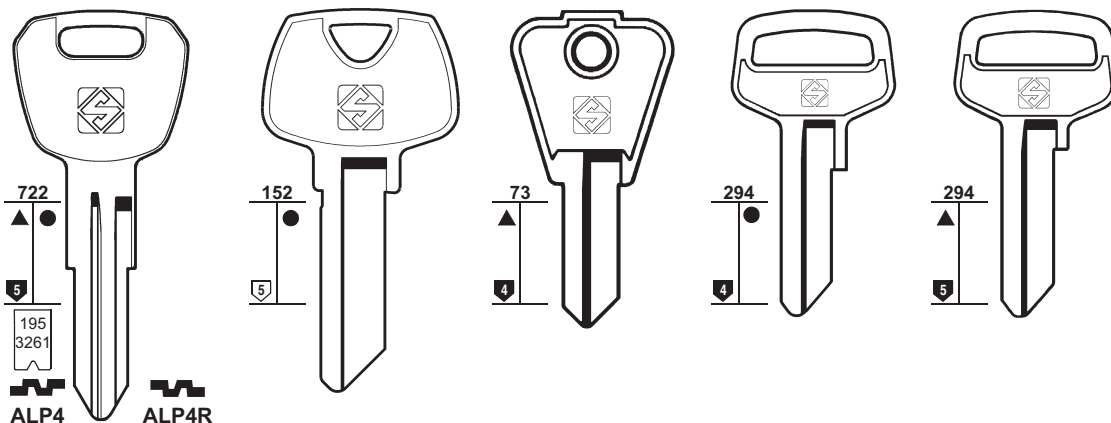

ALP4 ALP4R

S... 301-600

FEB

ALP9
7000...

ALP9R
LINCE
JD

ALP6R

ALP5R

ALP8R

ALP7R



MONACOR - SANY - VISONIC



HMP



HMP



HMP



15

PER / FOR

ALPHA (I)
 FEB
 HMP
 JD
 LINCE
 MONACOR
 SANY
 VISONIC
 + CHICAGO (46)

ALSO (USA)
 JUNKUNC (101)
 STS (162)

ALUBOX (I)

ALUNORM (I)
 CORBIN (53)

AM (I)
 POTENT (142)

AMARO LIMITADA (P)
 PICARDIE

AMELCO (BR)

AMERICAN (USA)
 JUNKUNC (101)

AMEROCK (USA)
 ARROW (18)

PER:
FOR:

ALPHA

ALUBOX

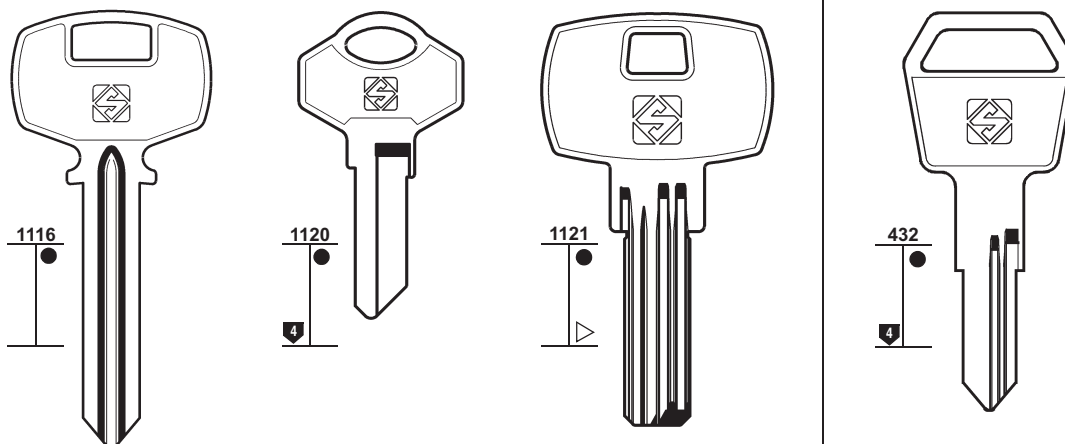

ALP12

ALP14R

ALP16

ALU1

PER:
FOR:

AMARO LIMITADA

AMELCO

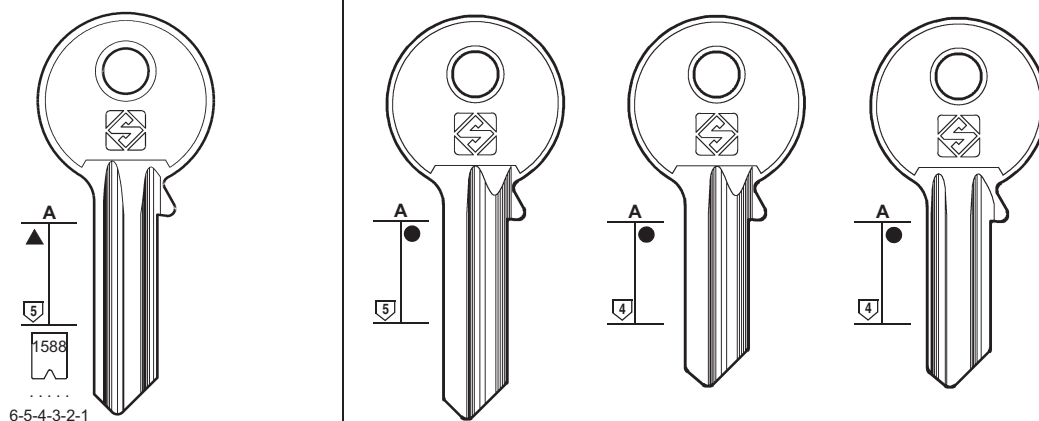

ALM1

ALM1R

AMC2R

AMC1R

AMC3

PICARDIE



16

PER / FOR

AMIG (E)

ANCHOR (S)
ANKERSLOT
+ ABUS (7-8)

ANHSIN (HK)

ANKERSLOT (NL)
ANCHOR
LITTO
ODA
+ ANCHOR (16)
+ LITTO (113)

PER:
FOR: AMIG

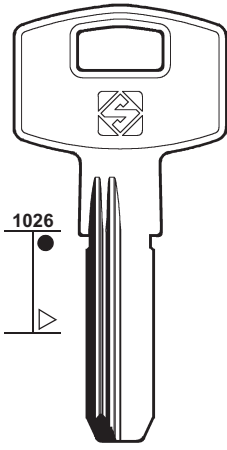

AMG1R



ANCHOR

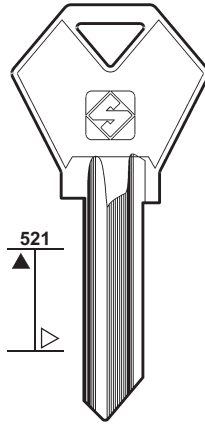

ACR1

ANKERSLOT

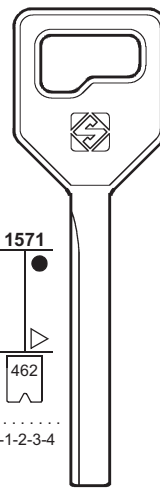

ACR3

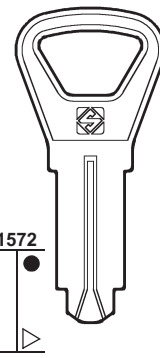

ACR4



ANHSIN

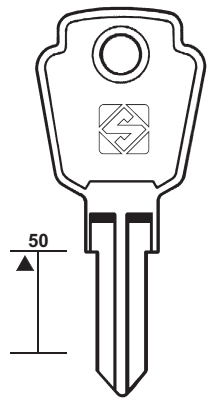

AH1

PER:
FOR:

ANKERSLOT

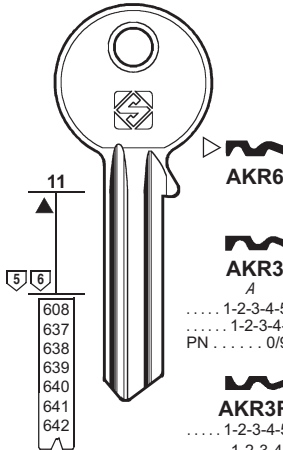

AKR6

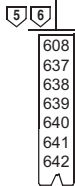

AKR3
A

..... 1-2-3-4-5-6-7
..... 1-2-3-4-5-6-7
PN 0/9 1-2-3-4-5-6-7

AKR3R

..... 1-2-3-4-5-6-7
..... 1-2-3-4-5-6-7
... L ... 1234567RSTUVWX



ODA

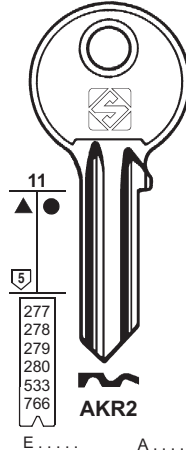

AKR2

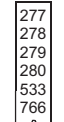

277
278
279
280
533
766
E
F
K
G
1-2-3-4-5-6-7



LITTO

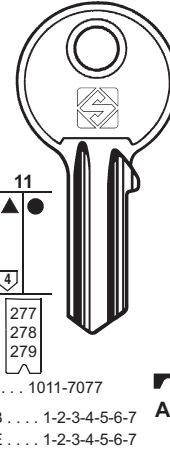

AKR1
A

..... 1011-7077
B 1-2-3-4-5-6-7
E 1-2-3-4-5-6-7
F 1-2-3-4-5-6-7
K 1011-7077
V 1-2-3-4-5-6-7
K ... 111-888



ANCHOR - LITTO - ODA

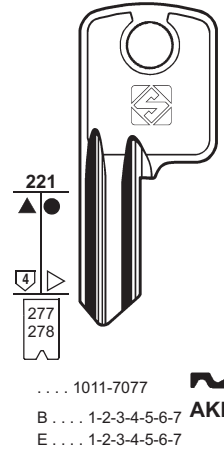

AKR7

..... 1011-7077
B 1-2-3-4-5-6-7
E 1-2-3-4-5-6-7
F 1-2-3-4-5-6-7
K 1011-7077
K ... 111-888



PER:
FOR:

ANKERSLOT

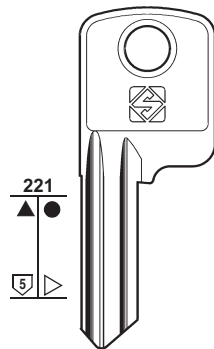

AKR10

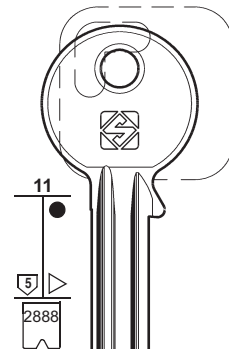

AKR15

PK
1-2-3-4-5-6-7

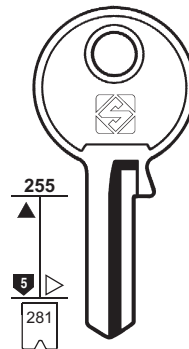

AKR5

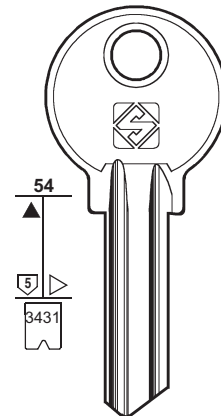

AKR4

.....
A111-GO777

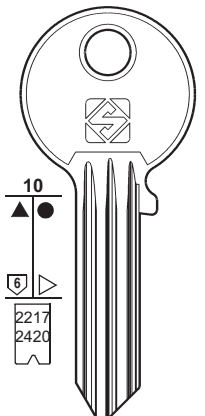

AKR8

..... 1-2-3-4-5-6-7-8-9
N 1 1-28800

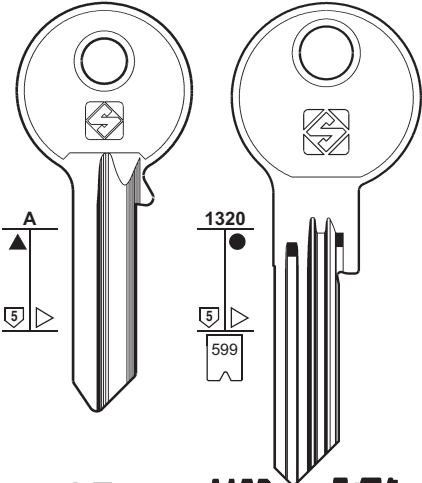
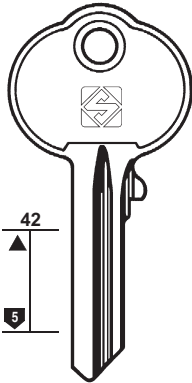
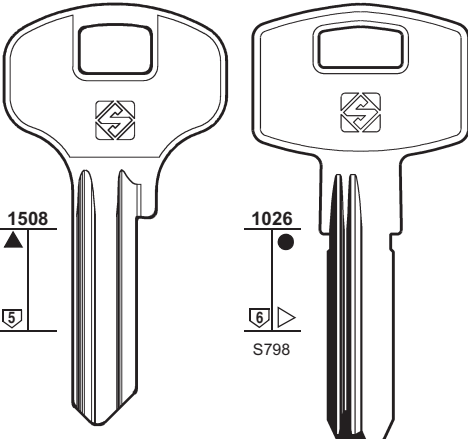
PER: FOR:	ANKERSLOT	ANTAR	APEKS	
	 <p>A 1320 599</p> <p>AKR9R AKR11R AKR14 V..... W..... X..... Z..... 1-65535</p>	 <p>42 5</p> <p>AN1 AN1R</p> <p>VEGA</p>	 <p>1508 5</p> <p>1026 S798</p> <p>APK1 APK2R</p>	



17

- PER / FOR**
- ANKERSLOT (NL)**
+ ANCHOR (16)
+ LITTO (113)
 - ANLO (F)**
+ GLOBE (87)
 - ANTAR (F)**
VEGA
+ RONIS (146-147)
 - APEKS (RUS)**
 - AQUILA (I)**
 - AREL (GB) (I)**
 - ARFE (E)**
STS
+ FORT (81)
+ STS (162)
 - ARMOR (F)**
+ RONIS (147)
 - ARMSTRONG (CZ)**
+ ABUS (8)
 - ARNOV (F)**
+ ZENITH (201)
 - AROUCA (BR)**

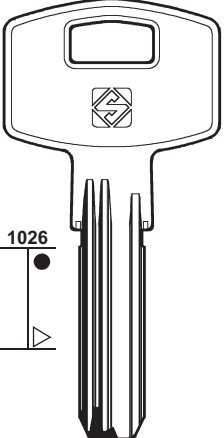
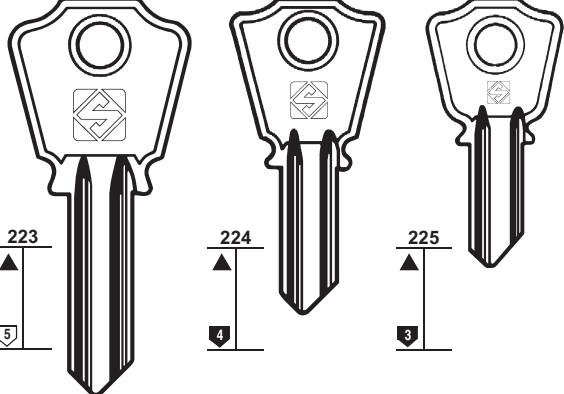
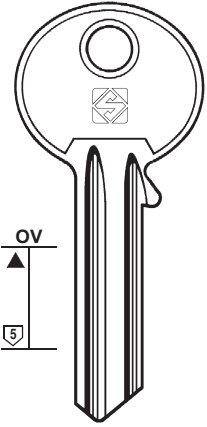
PER: FOR:	APEKS	AQUILA	AREL (GB)
	 <p>1026</p> <p>APK3R</p>	 <p>223 5</p> <p>224 4</p> <p>225 3</p> <p>AQ1 AQ1R AQ3 AQ3R AQ4 AQ4R</p>	 <p>OV 5</p> <p>ARE1</p>

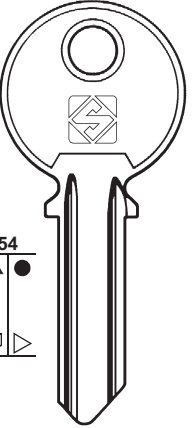
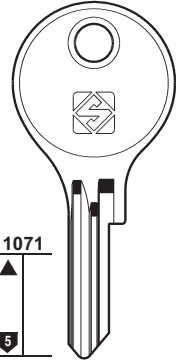
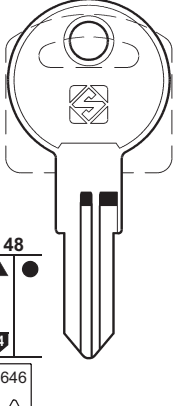
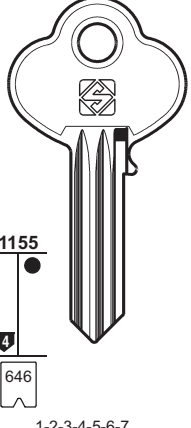
PER: FOR:	AREL (I)	ARFE	ARMSTRONG	AROUCA
	 <p>54</p> <p>ARL1 ARL1R</p>	 <p>1071 5</p> <p>ARF1</p> <p>STS</p>	 <p>48 4 646</p> <p>ART1 ART1R ... 101-801</p>	 <p>1155 4 646</p> <p>..... 1-2-3-4-5-6-7</p> <p>AUC1</p>



18

PER / FOR

AROUCA (BR)

ARREGUI (E)

AGA (10)

FAC (75)

ARROW (USA)

ALMET
AMEROCK
DOMINION
FORT
LG

ARSENJEVSK (RUS)

ASEC SECURITY (GB)

ALDRIDGE E. (13-14)

ASIA (RC)

TWIRHONB

+ YETI (198-199)

ASIAN (RC)

ASPA (NL)

+ DOM (63)

ASSA (S)

TEKA

+ RUKO (148)

PER:
FOR:

AROUCA

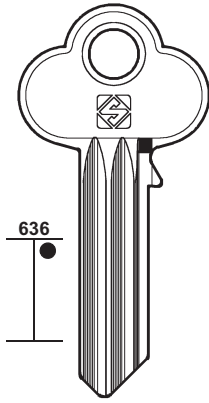

636



AUC4

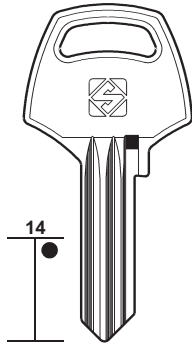

14



AUC5

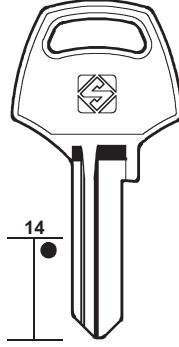

14



AUC6

ARROW

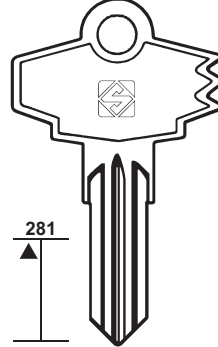

281



AW1



AW2

DOMINION - FORT - LG

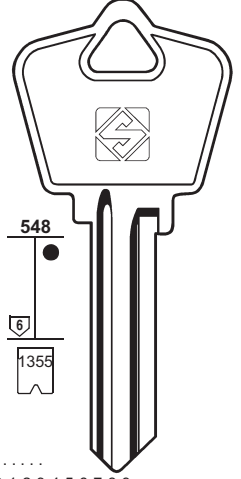

548

6

1355



AW3



AW4

.....
0-1-2-3-4-5-6-7-8-9



AW5
K7

AMEROCK

PER:
FOR:

ARROW

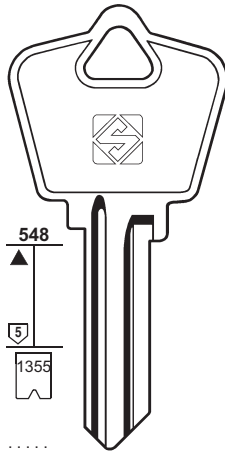

548

5

1355

.....
0-1-2-3-4-5-6-7-8-9



AW6
K7-5

ALMET

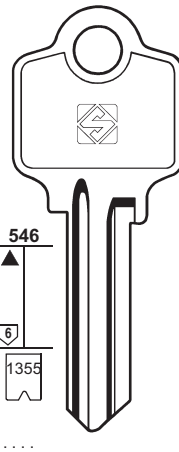

546

6

1355

.....
0-1-2-3-4-5-6-7-8-9



AW7
K2

ALMET

ARSENJEVSK

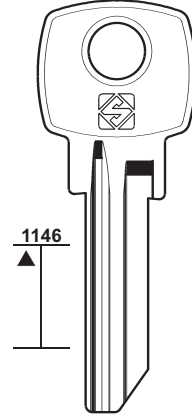

1146



ARS1

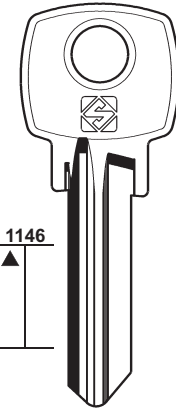

1146



ARS2

ASIA

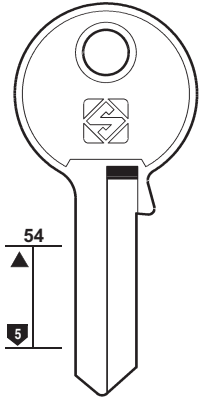

54

5



AS1

mm 45
TWIRHONB

PER:
FOR:

ASIAN

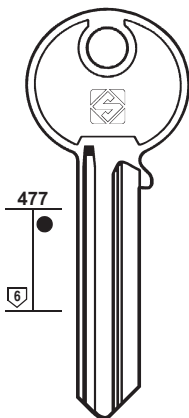

477

6



ASN1



ASPA

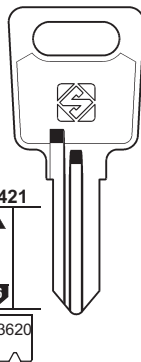

421

6

3620



APA1R
2U ... 1-748

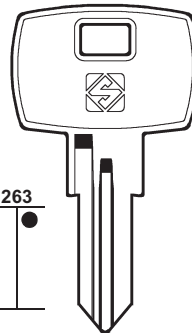

263



APA2R

ASSA

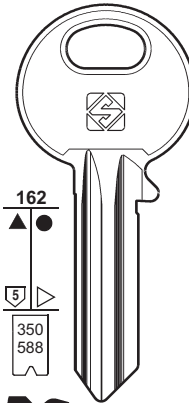

162

5

350
588



ASS63
22001



ASS6



ASS6R

20201 20301
..... 0-1-2-3-4-5-6-7-8-9-A-B-C
..... D-0-1-2-3-4-5-6-7-8-9-A-B-C

TEKA

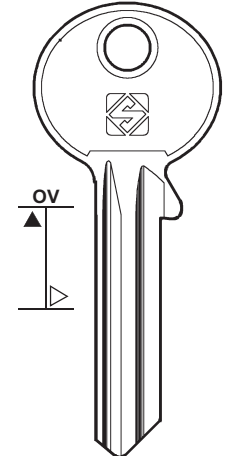

OV



ASS186

PER:
FOR:

ASSA

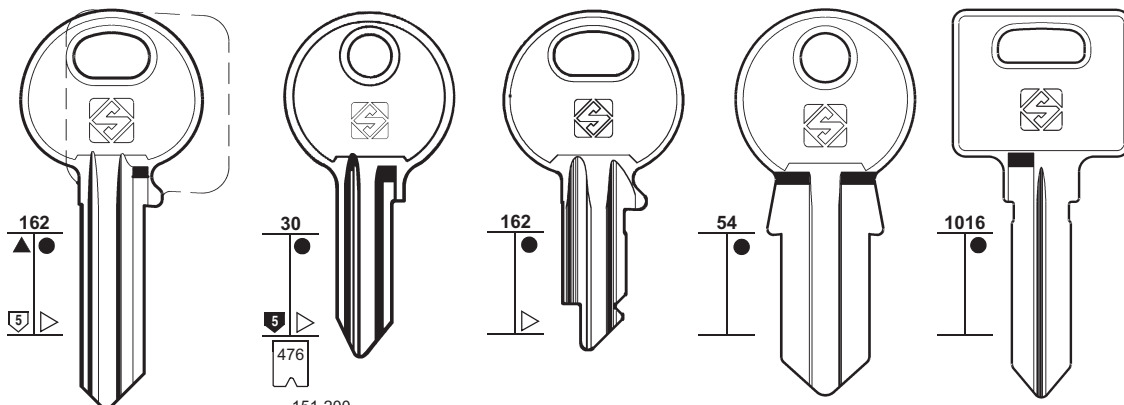

... 151-200
... 0-1-2-3-4-5-6

ASS137
22401

ASS47
21202

ASS181

ASS149

ASS148



19

PER / FOR

ASSA (S)
+ RUKO (148)

PER:
FOR:

ASSA

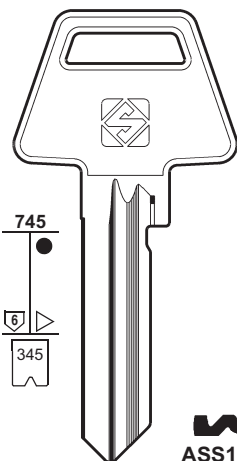

ASS122R
UM

ASS155
PK

ASS155R
UK

ASS142 TW
123456789
05-04

ASS150
11-08

ASS174
14-33

ASS143
05-05

ASS151
11-01

ASS175R
UL

ASS144 TW
123456789
05-13

ASS152
11-32

ASS176
TM

ASS145
14-01

ASS153
11-14

ASS177
TK

ASS146
14-09

ASS154
11-12

ASS178
TL

ASS147
14-25

ASS172
05-14

PER:
FOR:

ASSA

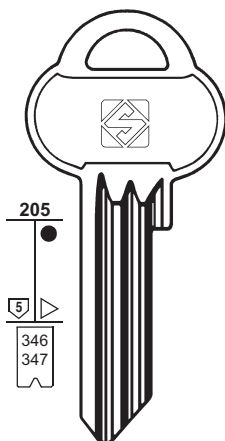

mm 28,7
560.

... 1-2-3-4-5-6-7
... 1-2-3-4-5-6-7-8

ASS9R

ASS9

ASS31R

ASS31

ASS11

ASS11R

ASS33

ASS33R

ASS2

ASS2R

ASS10R

ASS10



20

PER / FOR

ASSA (S)
+ RUKO (148)

PER:
FOR:

ASSA

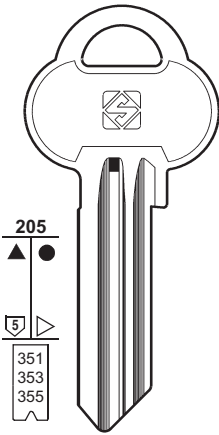

U ASS7

W ASS7R

D ASS64

H ● ASS64R

V ● ASS35R

T ● ASS35

RR ASS69

SS ▲ ASS69R

Z ▲ ASS37

X ASS37R

MM ASS68R

NN ASS44

PP ASS44R

FG ● ASS180R

5FG 10000-99809

. 1-2-3-4-5-6-7
. 1-2-3-4-5-6-7-8

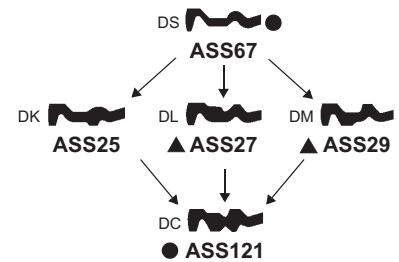
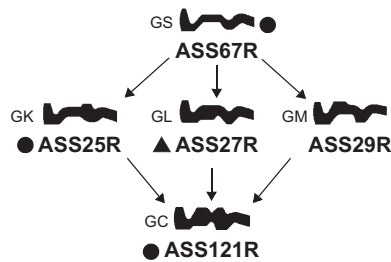
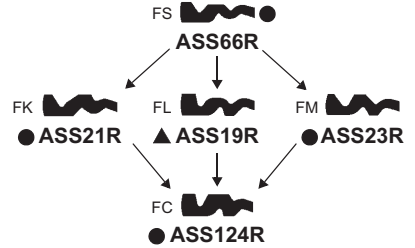
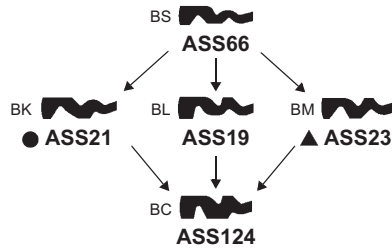
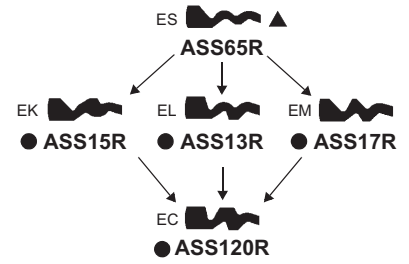
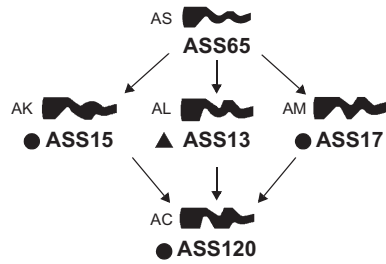

PER:
FOR:

ASSA



21

PER / FOR

ASSA (S)
+ RUKO (148)

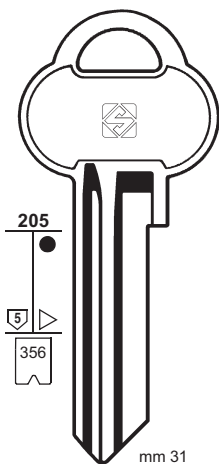

560.
..... 1-2-3-4-5-6-7

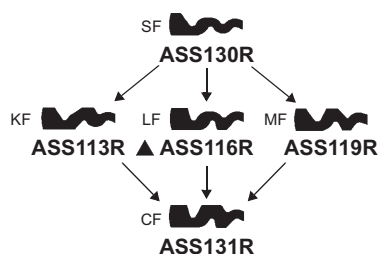
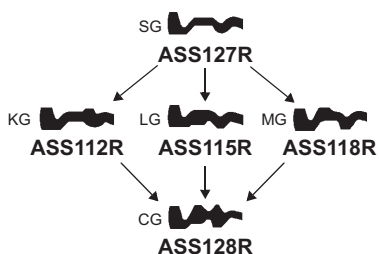
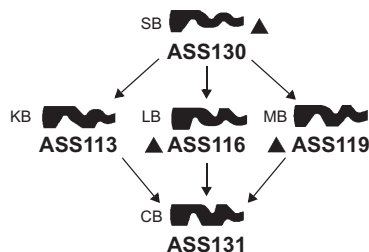
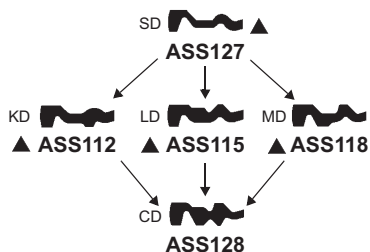
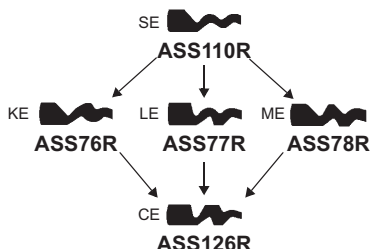
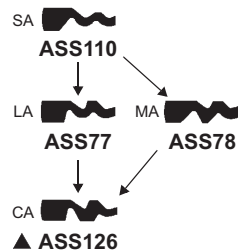
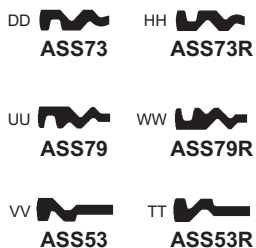

PER:
FOR:

ASSA

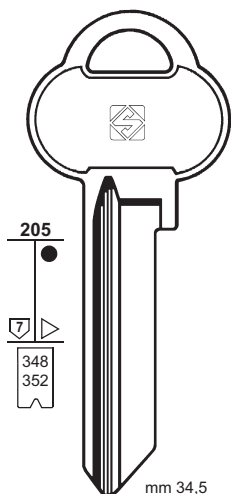

760.
..... 1-2-3-4-5-6-7

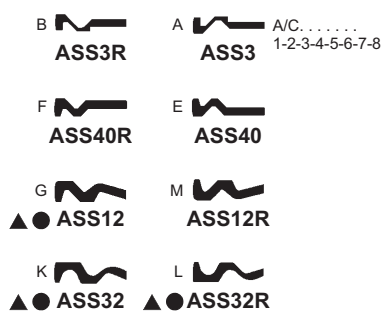



22

PER / FOR

ASSA (S)
+ RUKO (148)

PER:
FOR:

ASSA

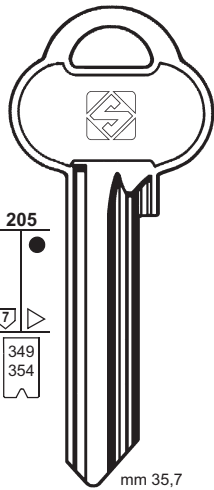

mm 35,7

760.

GG
ASS108

..... 1-2-3-4-5-6-7
..... 1-2-3-4-5-6-7-8

- D ASS4 H ASS4R
- U ASS8 W ASS8R
- V ASS34R T ASS34
- Z ASS36 X ASS36R
- NN ASS45 PP ASS45R
- RR ASS39 SS ASS39R
- KK ASS109 MM ASS48R

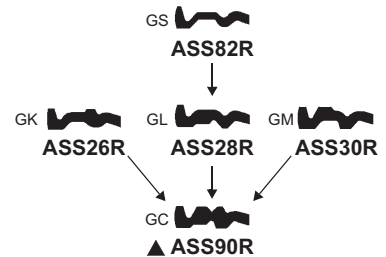
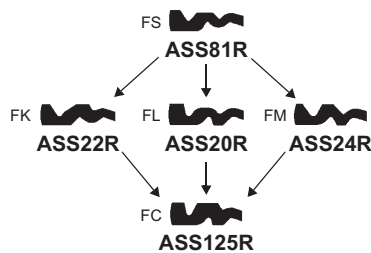
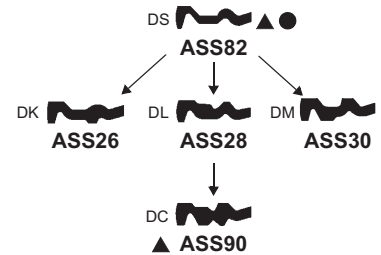
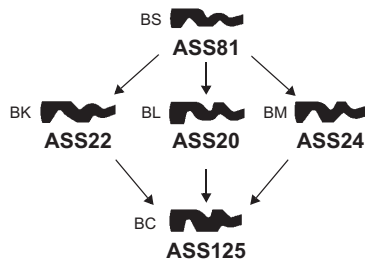
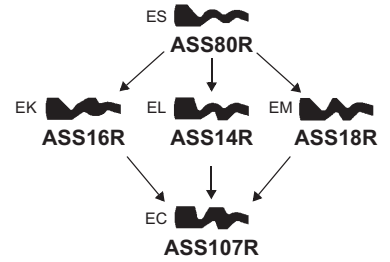
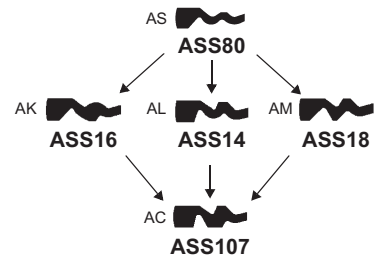

PER:
FOR:

ASSA



23

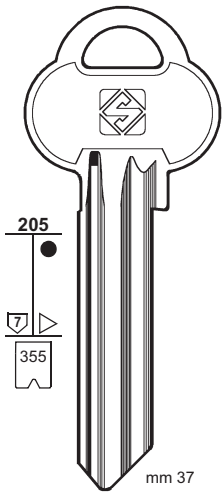

1DG 1-83499
 0FG 10000-99809
 0DG 1-99999
 DS 1-78678
 DJ 1-1234567
 SE 00001-43800
 1-2-3-4-5-6-7
 1-78670

- | | |
|------------------|------------------------|
| DD ASS52 | HH ASS52R ▲ ● ⊕ |
| PA ASS102 | PB ASS102R |
| PD ASS183 | PE ASS183R |
| PF ASS103 | PG ASS103R |
| PH ASS104 | PN ASS104R |
| PR ASS105 | PT ASS105R |
| UU ASS94 | WW ASS94R |
| VV ASS51 | TT ASS51R |
| | XX ASS106R |

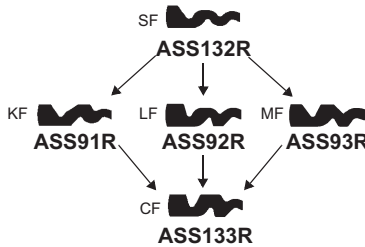
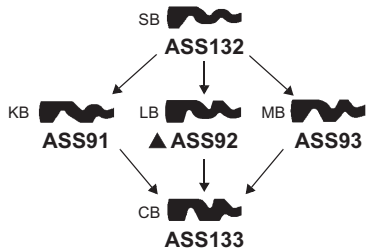
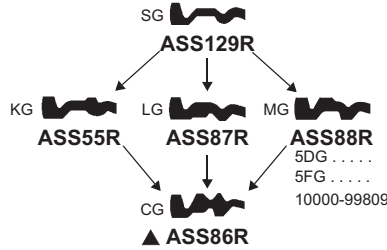
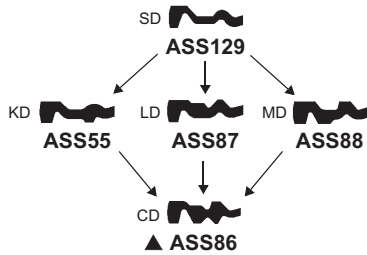
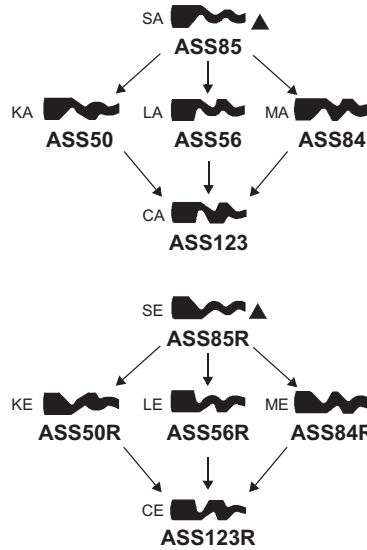

PER / FOR

ASSA (S)
 + RUKO (148)

ASTRA (AUS)

ATAL (F)
 KIFERM (106)
 LAS (110)
 L & F (116)
 RENZ (145)
 VACHETTE (181)

ATAY (RUS)

ATLAS (F)
 SUREX (163)

ATP (I)
 CITY (51)

AUBERT (F)
 ZENITH (201)

AUMON (E)

PER:
FOR:

ASTRA

ATAY

AUMON

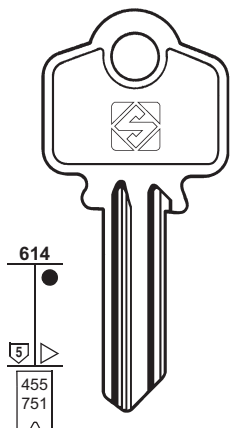

AT1
 0-1-2-3-4-5-6-7
 1-2-3-4-5-6-7-8

AT1R
 1-2-3-4-5-6-7-8

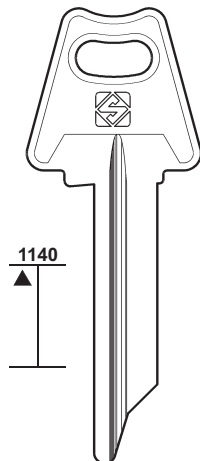

ATA1

ATA1R

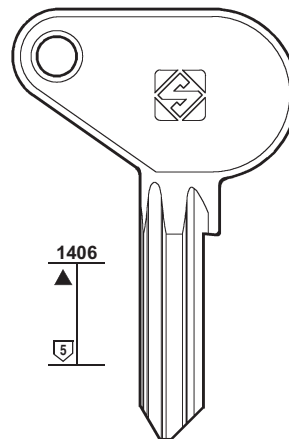

AUN1



24

PER / FOR

AUSTRAL LOCK (AUS)

AVA-CHUBB (S)

AVANGARD (RUS)

AVOCET (GB)
W.M.S.

AXA (NL)

AZBE (E)
CAVERS
+ TOK-WINKHAUS (171)

PER: AUSTRAL LOCK

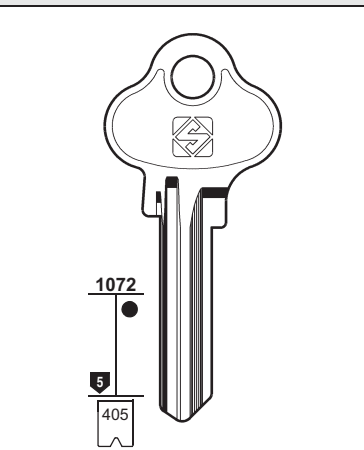

AUS1
..... 0-1-2-3-4-5-6-7-8-9-A

PER: AVA-CHUBB

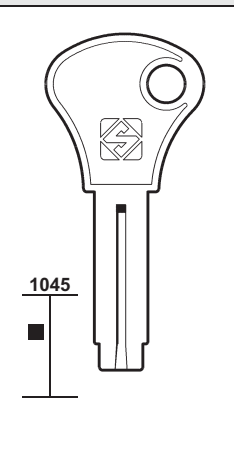

CHU7

PER: AVANGARD

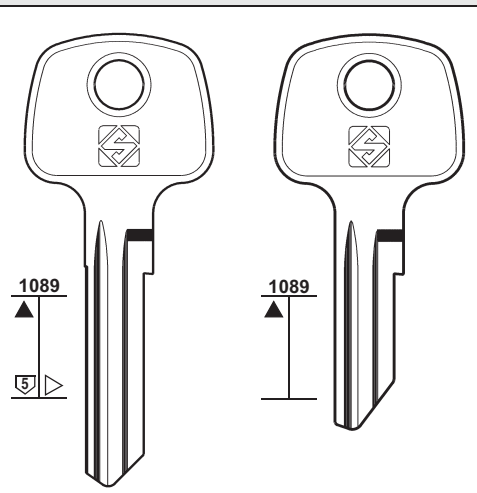

AV1 AV1R AV2

PER: AVOCET

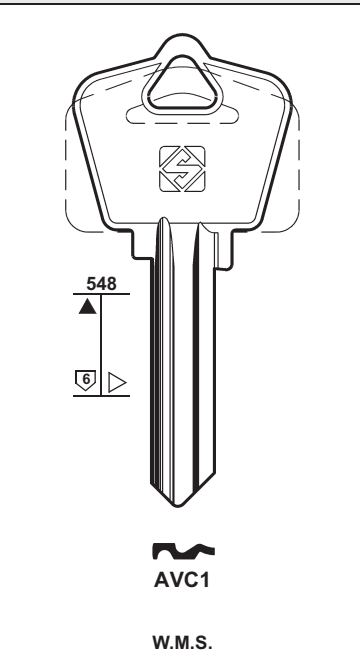

AVC1
W.M.S.

PER: AXA

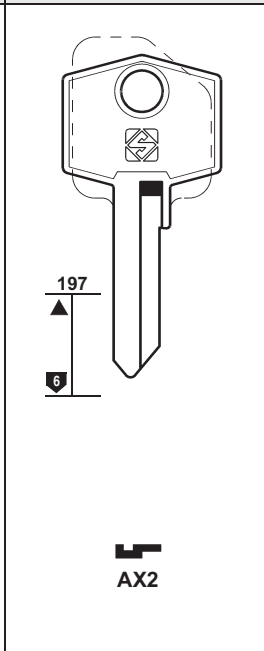

AX2

PER: AZBE

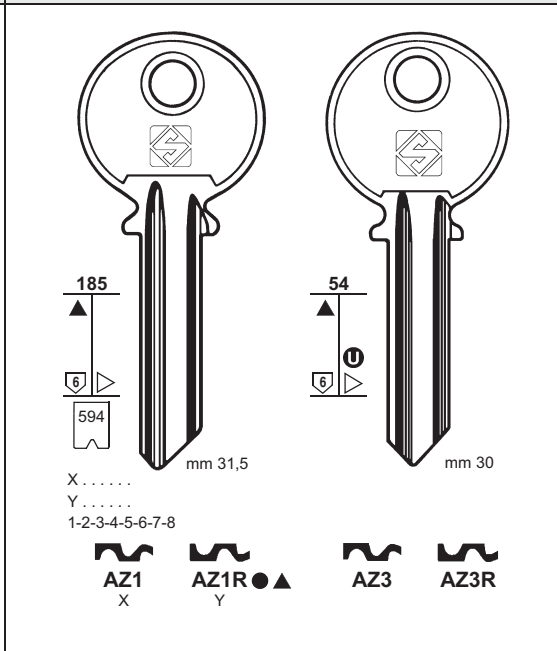

X
Y
1-2-3-4-5-6-7-8

AZ1 AZ1R AZ3 AZ3R

PER: AZBE

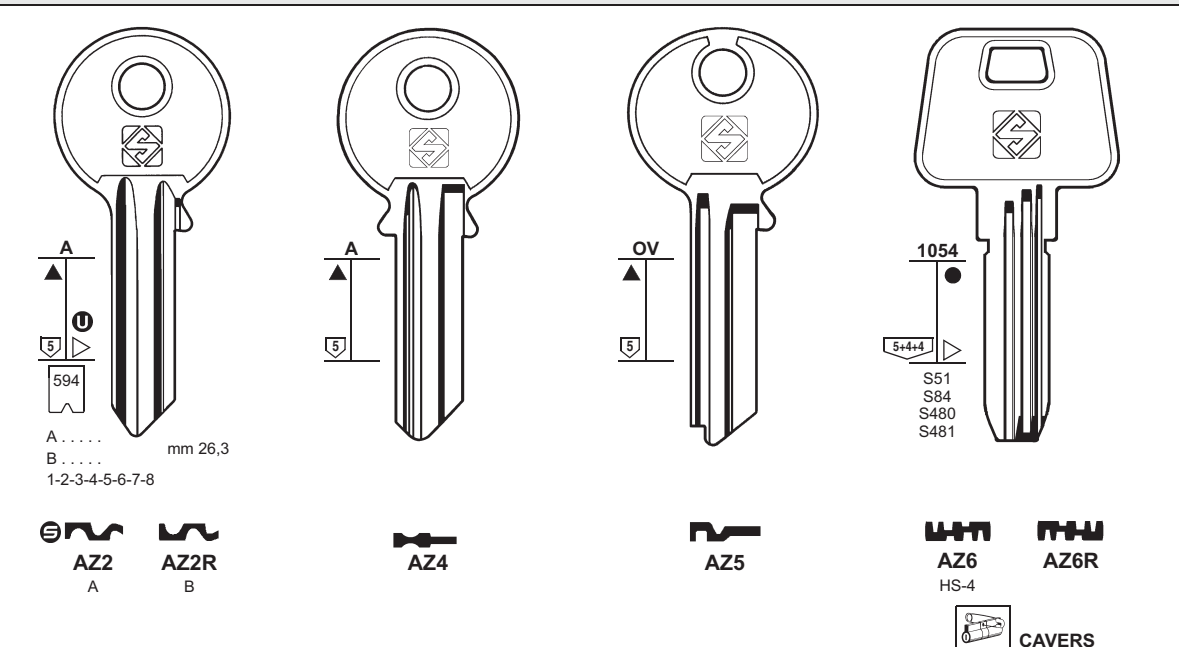

AZ2 AZ2R

AZ4

AZ5

AZ6 AZ6R



PER:
FOR:

AZBE

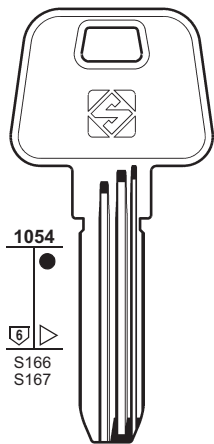

AZ7
HS-6

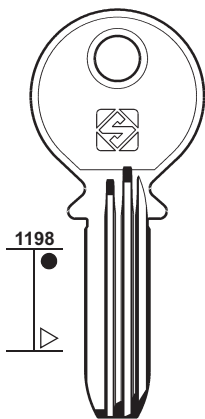

AZ8

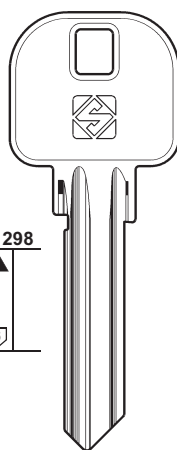

AZ9 **AZ9R**

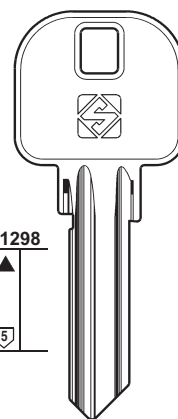

AZ10 **AZ10R**



25

PER / FOR

AZBE (E)
CAVERS
+ TOK-WINKHAUS (171)

AZMA (F)
VACHETTE (184)

BAAL (CH)
VÖGEL

BAB (D)
ESS

PER:
FOR:

BAAL

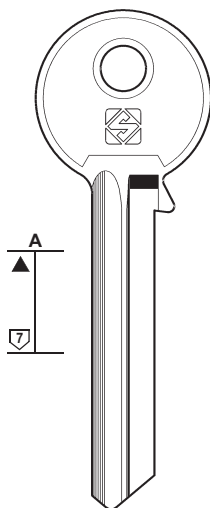

BAL7

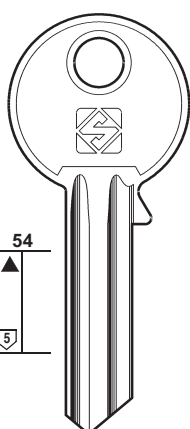

BAL5

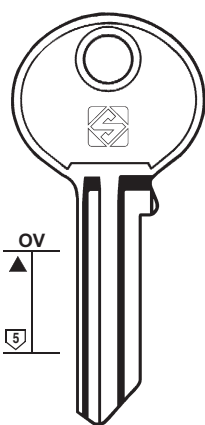

BAL1 **BAL1R**

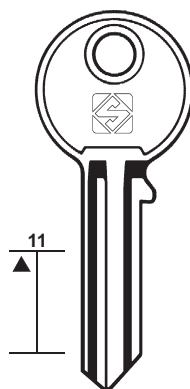

BAL2

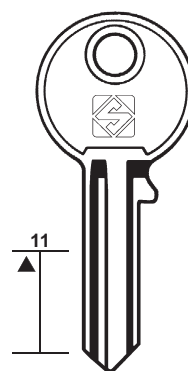

BAL3

VÖGEL

PER:
FOR:

BAAL

BAB

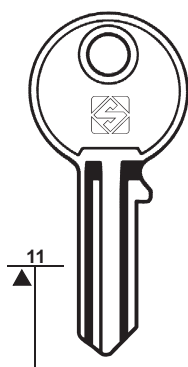

BAL4

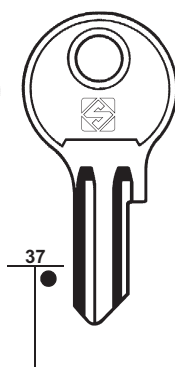

BAL6

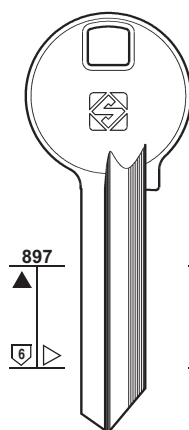

BAB6R

BAB7R

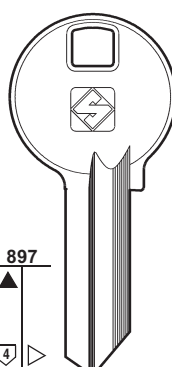

BAB4R

BAB5R

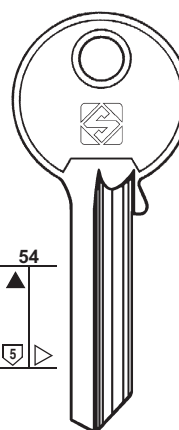

BAB2R

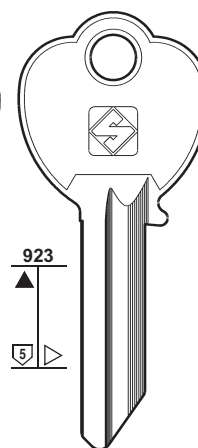

BAB18R

ESS



26

PER / FOR

BAB (D)
CORONA
HALLE
ZEISS-IKON

PER:
FOR:

BAB

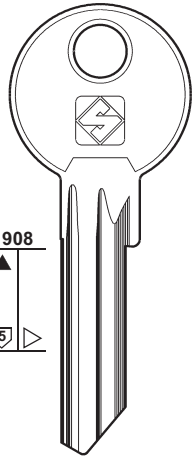

BAB14

ZEISS-IKON

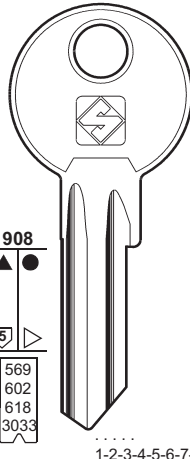

BAB13

CORONA - ZEISS-IKON

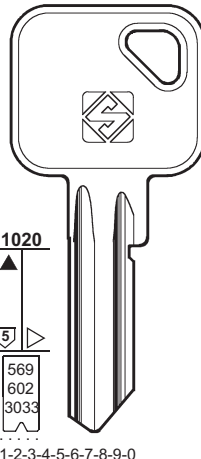

1-2-3-4-5-6-7-8-9-0
135679ACEGI

BAB13R

1234567890ABCDEFGHIJL



BAB25

1-2-3-4-5-6-7-8-9-0
135679ACEGI

BAB25R

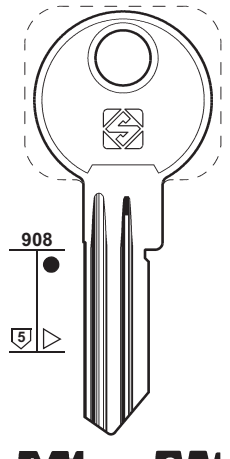

BAB27

BAB28R

BAB29

PER:
FOR:

BAB

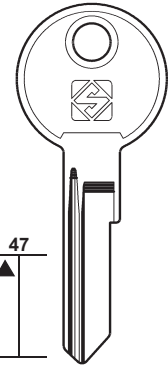

BAB15

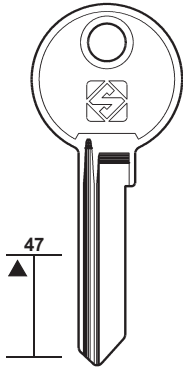

BAB16

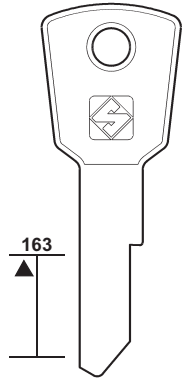

BAB19

HALLE

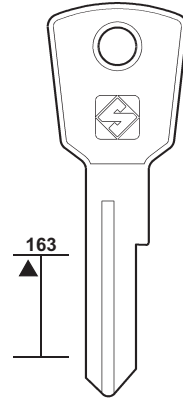

BAB20

HALLE

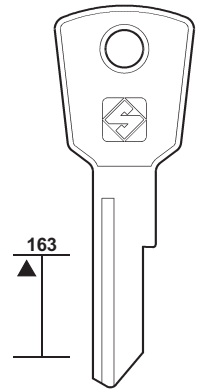

BAB21-3

BAB21-5

HALLE

BAB21-4

PER:
FOR:

BAB

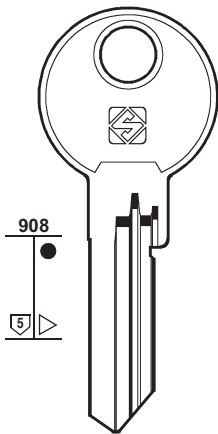

BAB26R-1

BAB26R-2

BAB26R-3

BAB26R-4

BAB26R-5

BAB26R-6

BAB26R-7

BAB26R-8

BAB26R-9

BAB26R-10

BAB26R-11

BAB26R-12



BAB26R-13

BAB26R-14

BAB26R-15

BAB26R-16

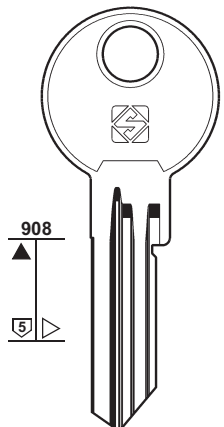
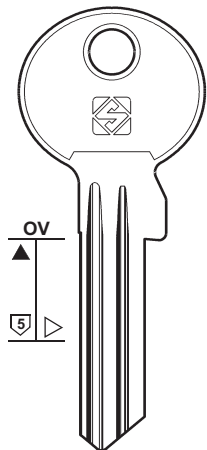
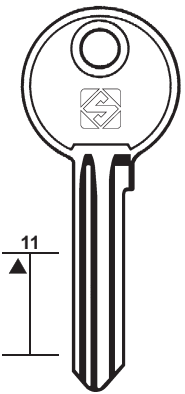
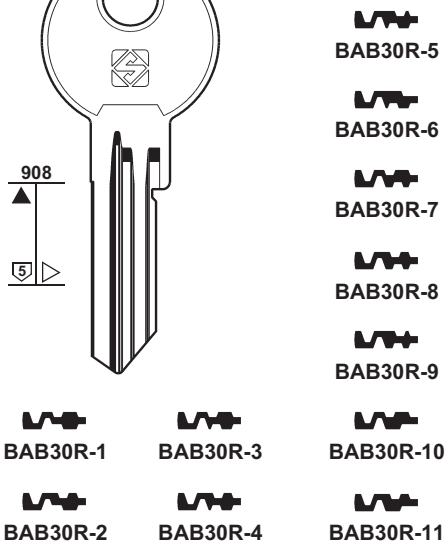

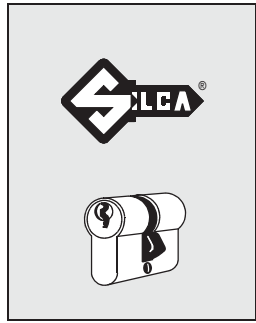

BAB26R-17





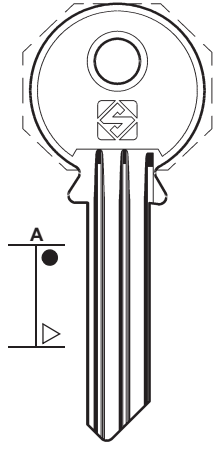
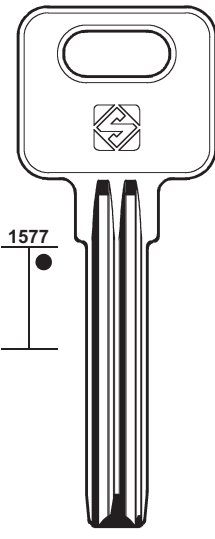
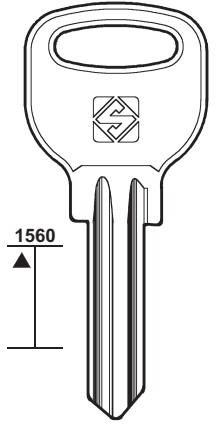



PER: FOR:	BAB		BABY CLIP
			
			
		BAB31 N26	EFSA - ETF

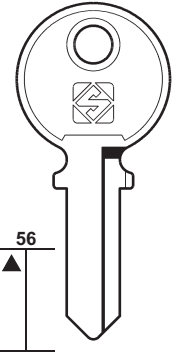
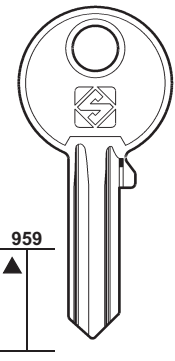
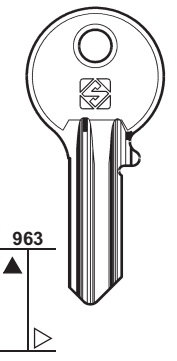
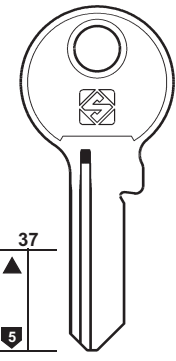
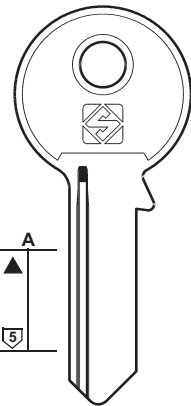

27

PER / FOR
BAB (D)
BABY CLIP (F) EFSA ETF
BAGEM (E) ABC (4)
BALDWIN (USA) SCHLAGE (151-152)
BALLY (I) TAMPALINI (164) ZANI (200)
BANE SEKULIĆ (SGC) BSS (36)
BANHAM (GB) + SIDLEEN (154)
BANKA (I) GIUSSANI (87)
BAODEAN (PRC)
BAODELI (PRC)
BARAS (GR)
BARGMAN (USA) ILCO (96)
BARRO (D) DOM (61)
BASI (D) + ABUS (8) + BUGA (36) + CISA (50-51) + EURO-LOCKS (71) + L & F (117)

PER: FOR:	BANHAM	BAODEAN	BAODELI
			
			

PER: FOR:	BARAS	BASI			
					
					
					
			mm 40	mm 50	



28

PER / FOR

- BASI (D)**
- CIC
- + ABUS (8)
- + BUGA (36)
- + CISA (50-51)
- + EURO-LOCKS (71)
- + L & F (117)

BASCO (USA)
BIZERBA
ELMO

BASSI (I)

BASTA (IRL)

BASTA (DK)
EURO LOCKS

BATON (RC)

PER:
FOR:

BASI

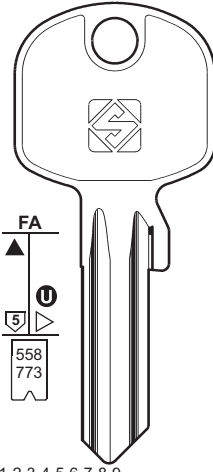

FA
5
558
773



BAI1

- 1-2-3-4-5-6-7-8-9
- 1-2-3-4-5-6-7-8-9-0
- 800001-803640

CIC

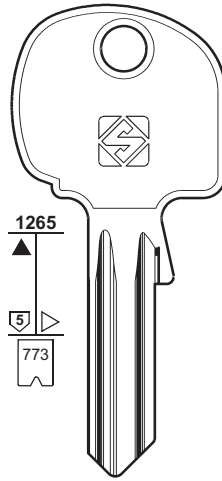

1265
5
773



BAI7

- 1-2-3-4-5-6-7-8-9-0
- 800001-803640

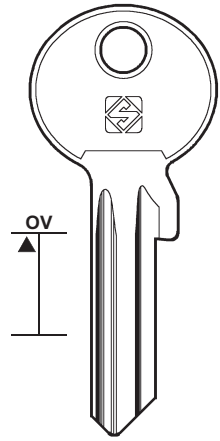

OV



BAI23

PER:
FOR:

BASCO

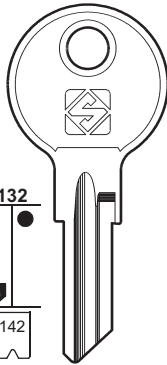

132
5
142



BA1



BA8

- C 1701-1950
- C 1951-2200
- C 250-499
- C 500-699

ELMO

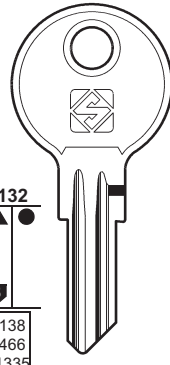

132
5
138
466
1335



BA5

- 101-350
- AN 1-500
- HC 0-499
- LL 1-326
- LL 1-200
- LL 1-200
- DD 1-250
- GC 101-150
- CH 751-1178
- RC 501-750

BIZERBA - ELMO



BA5R

- CH 501-750
- EM 501-750

BASSI

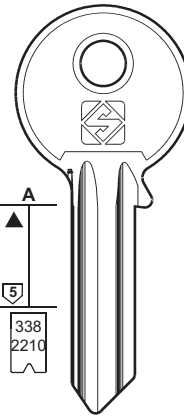

A
5
338
2210



TP1

- 0-1-2-3-4-5
- 1-2-3-4-5

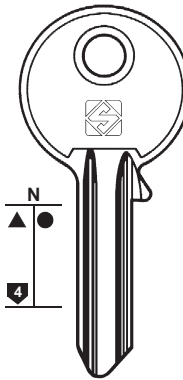

N
4



BSI2R

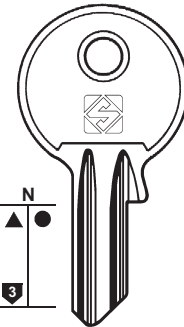

N
3



BSI1



BSI4



BSI4R



BSI1R

PER:
FOR:

BASTA (IRL)

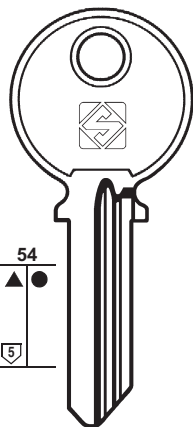

54
5



BAS1

BASTA (DK)

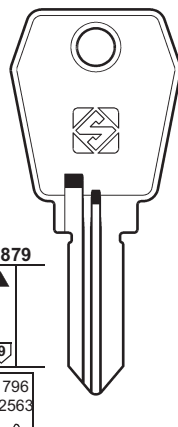

879
9
796
2563



BAS4R

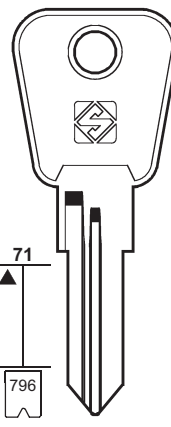

71
796



BAS5R

- C 1-1000

- M 1-1000
- V 1-1000
- W 1-1000
- C 1-1000

EURO LOCKS

Copyright by Silca S.p.A. 2013 - All rights reserved

BATON

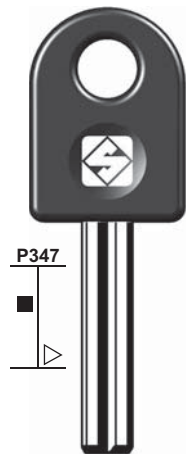

P347



BAT1P



PER: FOR:	BATON	BECCARINI	BELLEVILLE	BELL
	 BAT2	 BN2 BN2R	 BLV3	 BLL1 BLL3

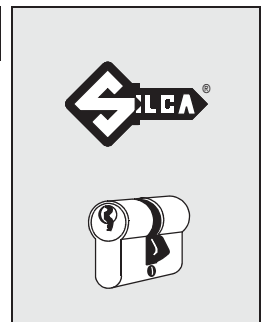

29

PER / FOR
BATON (RC)
BATU (E) CISA (50) IFAM (95)
BECCARINI (I)
BEDI (F) YETI (198-199)
BELLEVILLE (USA)
BELL (RC) + YETI (198-199)
BENCO (NL) YETI (199)
BENDIX (USA) YALE (194)
BERAM (RC) VIRO (187)
BERETTA (I) FASEM (77)
BERRY (D) BKS (30) CES (42)
BERTO (CH)
BERTOLOTTI (I) TICINO (166)
BEST (USA) FALCON
BETA (I) PICARD + CORNI (55)
BEY (TR)
BIB (I) MERONI (123)
BIBERING (D) TAS (165)

PER: FOR:	BERTO	BEST	BETA																																		
	 BRT1	<table border="0"> <tr> <td>A </td> <td>H </td> </tr> <tr> <td> BES1</td> <td>BES8</td> </tr> <tr> <td>..... 0-1-2-3-4-5-7-8-9</td> <td></td> </tr> <tr> <td>..... 0-1-2-3-4-5</td> <td></td> </tr> <tr> <td>..... 0-1-2-3-4-5-6-7-8-9</td> <td></td> </tr> <tr> <td>B </td> <td>J </td> </tr> <tr> <td>BES2</td> <td>BES9</td> </tr> <tr> <td>C </td> <td>K </td> </tr> <tr> <td>BES3</td> <td>BES10</td> </tr> <tr> <td>D </td> <td>L </td> </tr> <tr> <td>BES4</td> <td>BES11</td> </tr> <tr> <td>E </td> <td>FM </td> </tr> <tr> <td>BES5</td> <td>BES12</td> </tr> <tr> <td>F </td> <td>M </td> </tr> <tr> <td> BES6</td> <td>BES18</td> </tr> <tr> <td>G </td> <td></td> </tr> <tr> <td>BES7</td> <td></td> </tr> </table>	A	H	BES1	BES8 0-1-2-3-4-5-7-8-9	 0-1-2-3-4-5	 0-1-2-3-4-5-6-7-8-9		B	J	BES2	BES9	C	K	BES3	BES10	D	L	BES4	BES11	E	FM	BES5	BES12	F	M	BES6	BES18	G		BES7		 1-2-3-4-5-6 1-2-3-4-5-6
A	H																																				
BES1	BES8																																				
..... 0-1-2-3-4-5-7-8-9																																					
..... 0-1-2-3-4-5																																					
..... 0-1-2-3-4-5-6-7-8-9																																					
B	J																																				
BES2	BES9																																				
C	K																																				
BES3	BES10																																				
D	L																																				
BES4	BES11																																				
E	FM																																				
BES5	BES12																																				
F	M																																				
BES6	BES18																																				
G																																					
BES7																																					
		FALCON	PICARD																																		

PER: FOR:	BETA	BEY
	 1-2-3-4-5-6	
		S2953



30

PER / FOR

BIELLE (I)
FASEM
OMIV
P.C.

BIFFAR (D)
TOK-WINKHAUS (171)

BILMA (E)

BIGLA (CH)

BIRD (HK)
YALE (193)

BIZERBA (HK)
BASCO (28)

BKS (D)
BERRY
DAMM
GEBÄ
HÄFELE
HÖHRMANN
YALE
+ LITTO (113)
+ YALE (193-194)

PER: **BIELLE**
FOR:

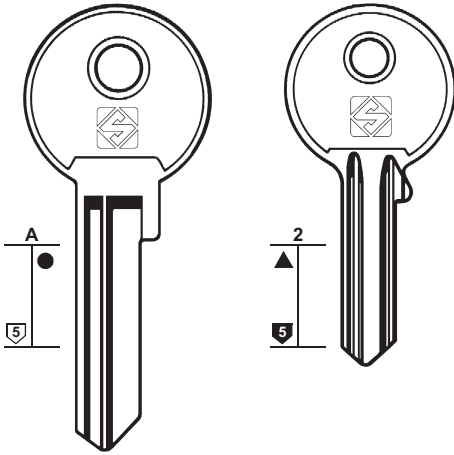

BI110

BI062

▲●BI063

FASEM - OMIV - P.C.

PER: **BILMA**
FOR:

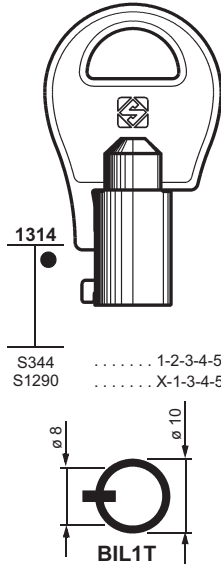

S344 1-2-3-4-5-6
S1290 X-1-3-4-5-6

BIL1T

PER: **BIGLA**
FOR:

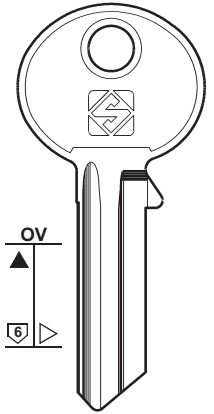

BG1

PER: **BKS**
FOR:

BK3-1	●●BK3-7	▲BK7R-1	BK7R-6	
BK3-2	●●BK3-8	BK7R-2	BK7R-7	▲ BK27
●●BK3-3	BK3-9	BK7R-3	BK7R-8	▲ BK23R
●●BK3-4	BK3-10	BK7R-4	BK7R-9	▲ BK22R
▲ BK1R	▲ BK3-5	BK3-11	BK7R-5	▲ BK21R
▲ BK2R	YA9	BK3-6	●●BK3-12	▲ BK13

PZ **▲●BK1**
 01234567
 0123456789
 1234567890ABCDEFGHIJ
 050001-80453

Serie O
 BERRY - DAMM - GEBÄ - HÖHRMANN - YALE

BK1X
 PZ
 0211
 1234567890ABCDEFGHIJ

PER: **BKS**
FOR:

BK18 0212	BK28 17	BK36 04
BK17 0213	BK29 19	BK38 06
BK16 0214	BK30 01	BK37 05
PZ ▲●BK15 01234567 0123456789 1234567890ABCDEFGHIJ 050001-80453	BK31 02	BK32 09
HÄFELE	BK20 07	BK34 14

PER:
FOR:

BKS

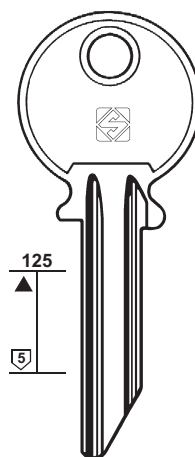
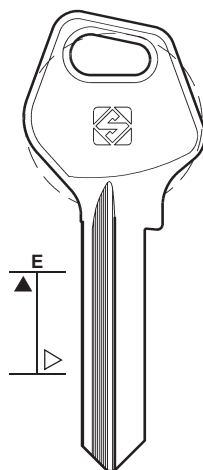
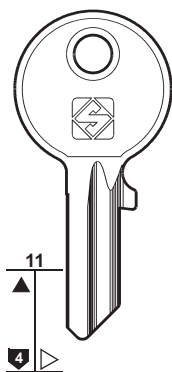
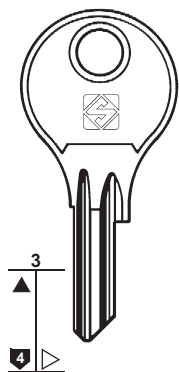

BK4



BK4R

34



BK8



BK8R



BK11R



BK26



LT1

METEOR - YALE



31

PER / FOR

BKS (D)
METEOR
YALE
 + LITTO (113)
 + YALE (193-194)

PER:
FOR:

BKS

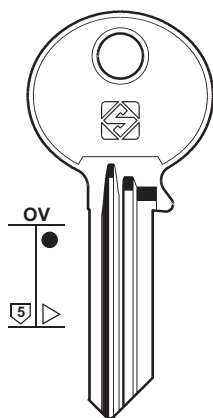

Serie 1000



BK5-1



BK5-9



BK5-17



BK5-25



BK5-33



BK5-2



BK5-10



BK5-18



BK5-26



BK5-34



BK5-3



BK5-11



BK5-19



BK5-27



BK5-35



BK5-4



BK5-12



BK5-20



BK5-28



BK5-5



BK5-13



BK5-21



BK5-29



BK5-6



BK5-14



BK5-22



BK5-30



▲ BK5-7



BK5-15



▲ BK5-23



BK5-31



BK5-8



BK5-16



BK5-24



BK5-32

PER:
FOR:

BKS

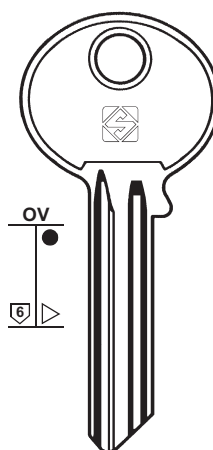

Serie 1000



BK6-1



BK6-9



▲ BK6-17



BK6-25



BK6-33



BK6-2



BK6-10



BK6-18



BK6-26



BK6-34



BK6-3



BK6-11



BK6-19



BK6-27



BK6-35



BK6-4



BK6-12



BK6-20



BK6-28



BK6-5



BK6-13



BK6-21



BK6-29



BK6-6



BK6-14



BK6-22



BK6-30



BK6-7



BK6-15



BK6-23



BK6-31



BK6-8



BK6-16



▲ BK6-24



BK6-32



32

PER / FOR

BKS (D)

+ LITTO (113)

+ YALE (193-194)

BLASER (CH)

VADETO

WILKA

BLINKY (PRC)

BLOCKSHAFT (I)

BLOCTOUT (F)

+ BRICARD (35)

BLOCUS (F)

+ PREFER (142)

+ RONIS (146)

BMB (D)

BODA (FIN)

+ CES (41-42-43-44)

PER:
FOR:

BKS

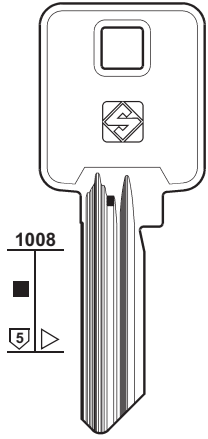

1008

5

BK10-00
Serie 2000

BK10-01

BK10-07

BK10-13

BK10-19

BK10-02

BK10-08

BK10-14

BK10-20

BK10-03

BK10-09

BK10-15

BK10-21

BK10-04

BK10-10

BK10-16

BK10-22

BK10-05

BK10-11

BK10-17

BK10-23

BK10-06

BK10-12

BK10-18

BK10-30

PER:
FOR:

BLASER

BLINKY

BLOCKSHAFT

BLOCUS

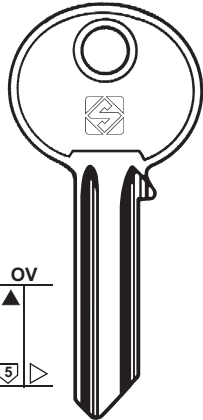

OV

5

BLA3

BLA1

BLA2
WILKA

VADETO

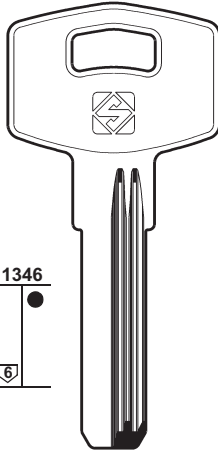

1346

6

BNK1

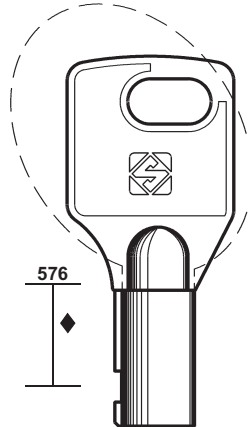

576

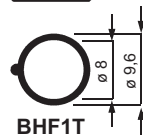

BHF1T

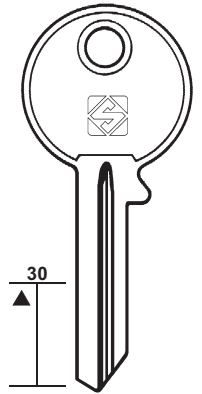

30

BL1

BL1R

PER:
FOR:

BMB

BODA

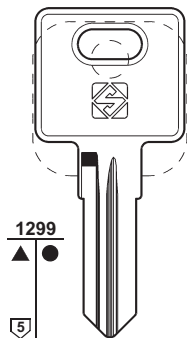

1299

5

BMB1

BMB1R

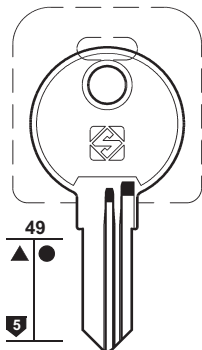

49

5

BMB2

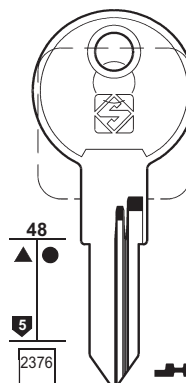

48

5

2376

BMB3
A ... 1-200

BMB5
A ... 401-600

BMB3R
A ... 1-200

BMB4
A ... 201-400

BMB4R
... 1-2-3

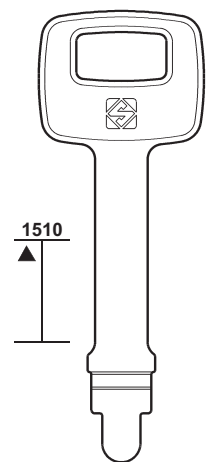

1510

BDA10

PER: FOR:	BOMMER	BOMORO		BÖRKEY
	 BOR1 BOR1R	 BO2 BO2R	 BO6 BO6R	 BY1
		LAPORTE - PRESTA		HUWIL

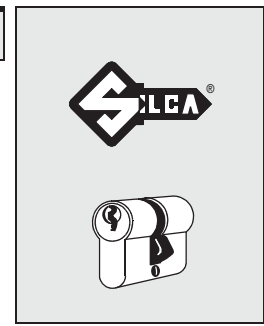

33

PER / FOR
BOMMER (USA)
BOMORO (D) HUWIL LAPORTE PRESTA
BÖRKEY (D) + KABA (102)
BOSS (I) MARLIN
BOTT (F) CES (42)
BRABANTIA (E) CLAUSOR (51) ME-FA (122)
BRASIL (BR)

PER: FOR:	BOSS		BRASIL	
	 BOS1	 BOS3	 BRA1R	 BRA2R
	 mm 60 MARLIN	 mm 70-90	 BRA3R	

PER: FOR:	BRASIL			
	 BRA16R	 BRA7R 1-2-3-4-5 1-2-3-4-5-6	 BRA9R	 BRA10R



34

PER / FOR

BRASIL (BR)

BRETER (I)
GIUSSANI
ZADI

+ GIUSSANI (86)

PER:
FOR:

BRASIL

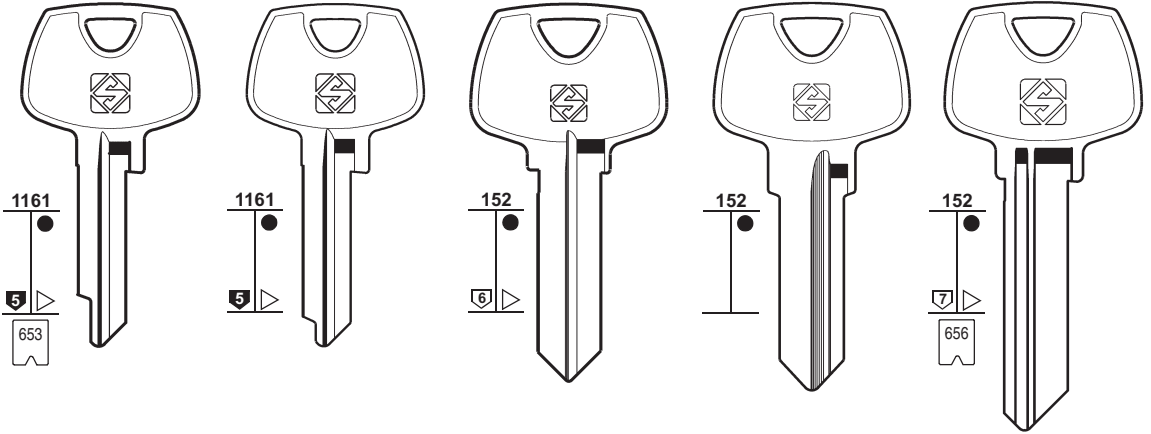

BRA6R

..... 1-2-3-4-5-6



BRA11R



BRA8R



BRA15R



BRA5

..... 1-2-3-4-5-6-7

PER:
FOR:

BRETER

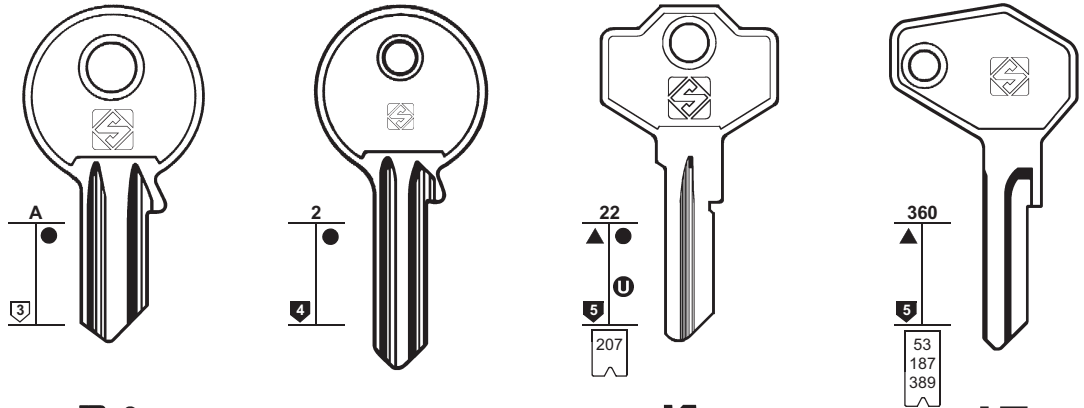

BR1



GS3



GS3R



SM1

G... 0-480
... 3001-3480
G... 3001-3480
... 9001-9741
G... 9001-9741



ZD7

... 0001-1625
E... 1-500
... 501-710
... 9001-9500



GIUSSANI



GIUSSANI



ZADI

PER:
FOR:

BRETER

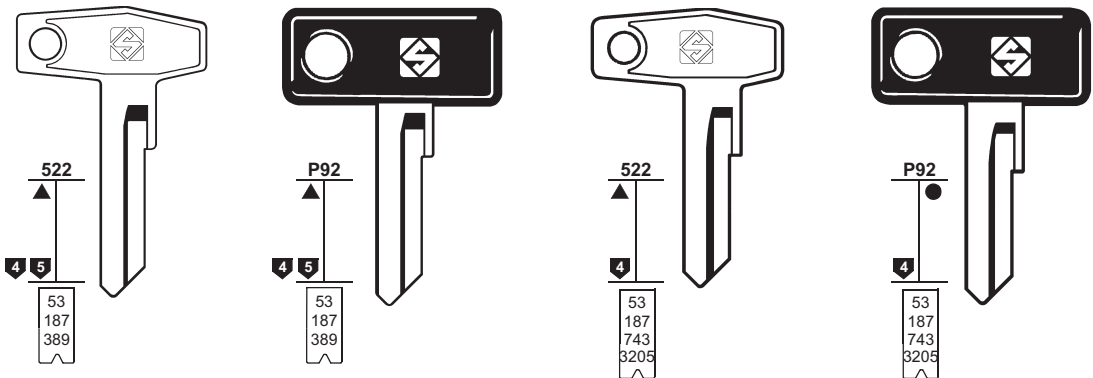

ZD9

... 1-1625
E... 500
... 501-710
... 9001-9500
... 5001-6278



ZD9P

... 1-1625
E... 500
... 501-710
... 9001-9500
... 5001-6278



ZD11

... 1-1625
E... 1-500
... 5001-6278
E... 501-710
... 1234
H... 100-341



ZD11P

... 1-1625
E... 1-500
... 5001-6278
E... 501-710
... 1234
H... 100-341



ZADI



ZADI



PER:
FOR:

BRICARD

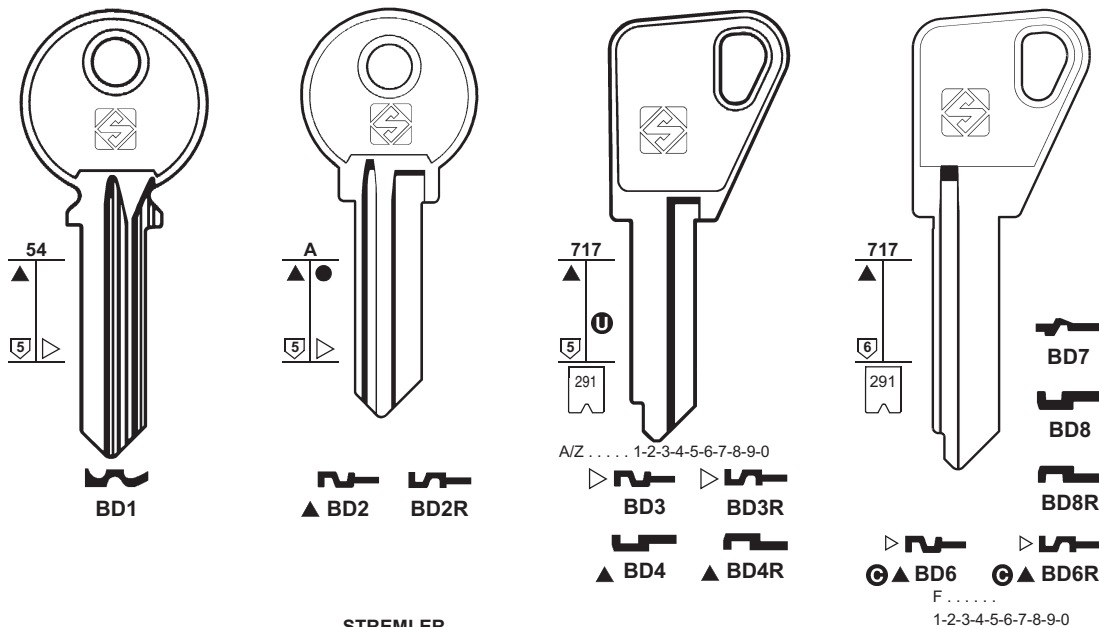

35

PER / FOR

- BRICARD (F)**
 ABUS
 BLOCTOUT
 INLOC
 STREMLER
 + ABUS (7-10)
 + CISA (48-49)
 + G.R. (90)
 + KWIKSET (108)
 + LOB (114)
 + SARGENT (150)

PER:
FOR:

BRICARD

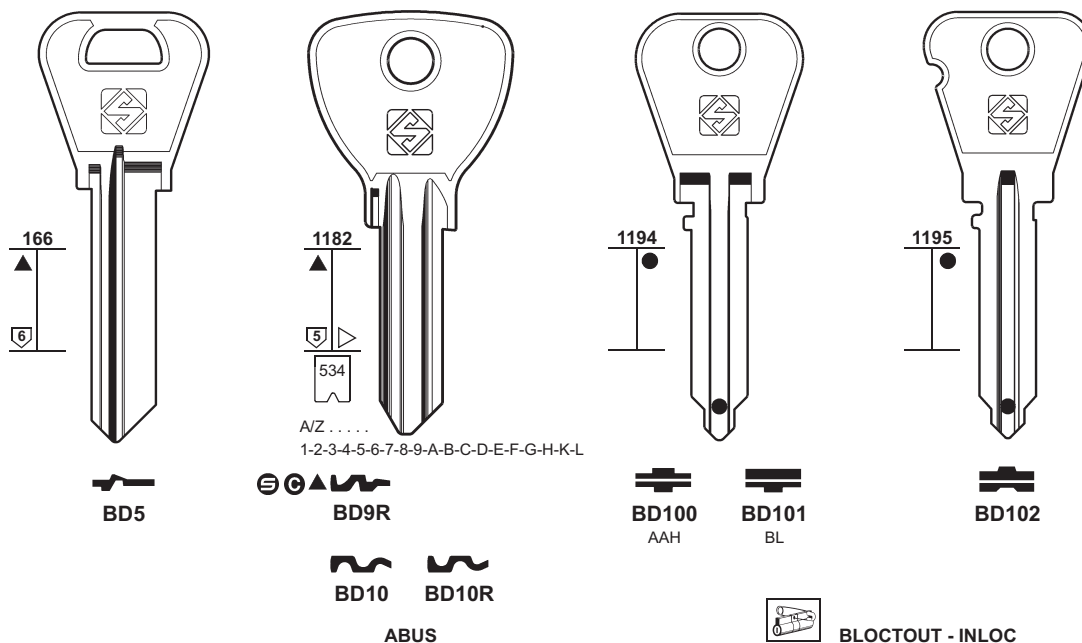

PER:
FOR:

BRICARD

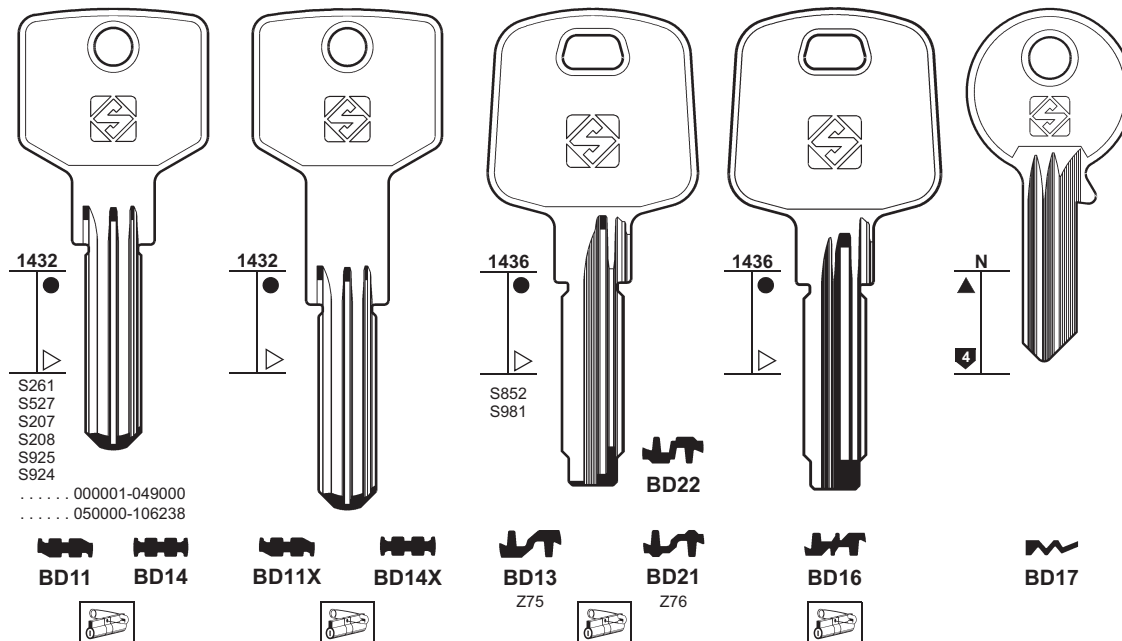



36

PER / FOR

BRUMME (D)

FANA

FTH

+ ZEISS-IKON (201)

BSS (SCG)

BANE SEKULIĆ

+ URBIS (180)

BTV (E)

AGA (10)

DOM (61)

STS (162)

BUFFO (GR)

ABUS (7-9)

BUG (D)

CORONA (55)

BUGA (F)

BASI

CITY

IFAM

BULAT (PRC)

BULLDOG (GB)

BULLOCK (I)

ZADI (200)

BURAM (YU)

PER: **BRUMME**

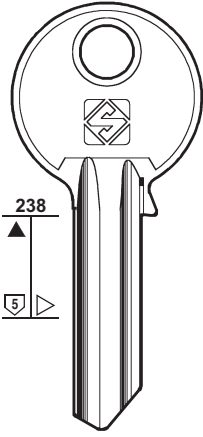

238
▲
5



BRM1 **BRM1R**

FANA - FTH

BSS

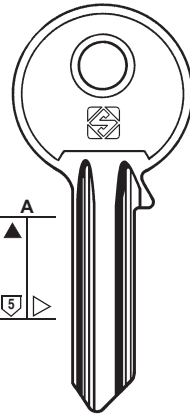

A
▲
5



BS1

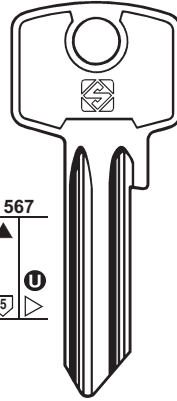

567
▲
5



BS2



BS7

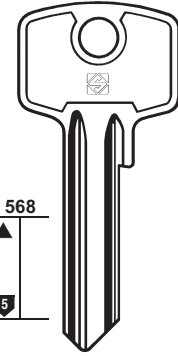

568
▲
5



BS3



BS4R

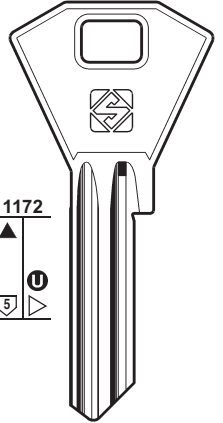

1172
▲
5



BS5



BS5R

BANE SEKULIĆ

PER: **BSS**

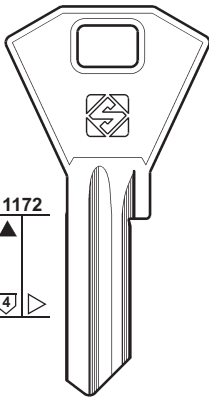

1172
▲
4



BS6R

BUGA

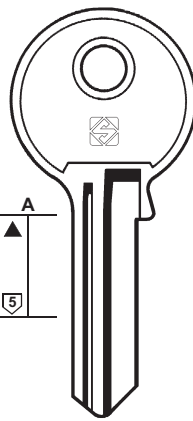

A
▲
5



CS33



CS33R

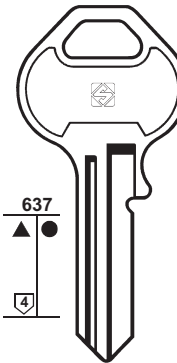

637
▲
4



CS32



CS32R

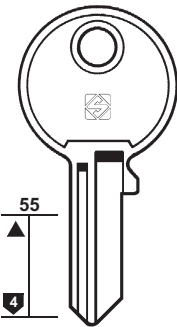

55
▲
4



CS26



CS26R

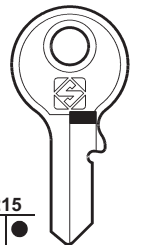

215
▲
3



CS23



CS23R

BASI



mm 50-60

BASI - CITY



mm 40

CITY



mm 30

BASI - IFAM



mm 20

PER: **BULAT**

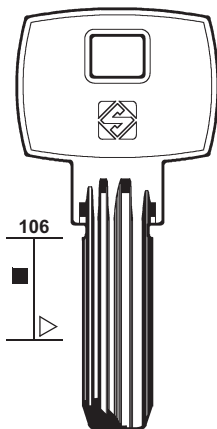

106
■
▶



BUT1R



BULLDOG

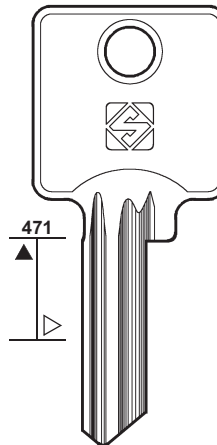

471
▲
▶



BLG1

BURAM

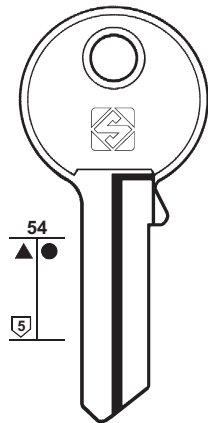

54
▲
5



BU1



BU1R

PER:
FOR:

BURG

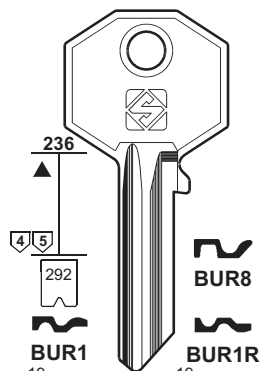

BUR1	BUR8
19	19
20	20
21	22
23	24
27	28
29	30
31	32
33	34
49	799
769	0-1-2-3-4-5-6
799	

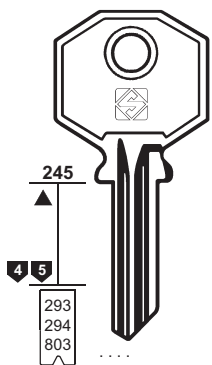

BUR2
11
12
13
14
15
16
17
18
25
30
35
36
37
38
40
41
42
43
44
45
47
50
51
52



BUR2	BUR2R
11	11
12	12
13	26
14	46
15	309
16	329
17	349
18	369
25	389
30	419
35	439
36	459
37	519
38	539
40	559
41	579
42	599
43	619
44	639
45	669
47	679
50	699
51	719
52	739
	759
	789
	809
	819
	829

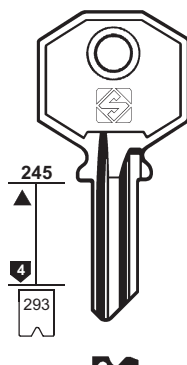

BUR6
11
12
259
269
279
0-1-2-3-4-5-6

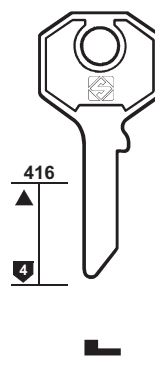

37

PER / FOR

- BURG (D)**
- MELSMETALL**
- + ABUS (8)
- + HOPPE (93)
- + MELSMETALL (122)
- + OJMAR (134)
- + RONIS (147)
- + VIRO (187)
- + ZEISS-IKON (201)

PER:
FOR:

BURG

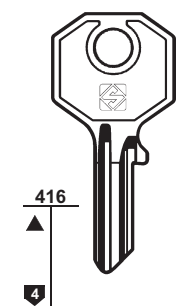

BUR11
BUR4

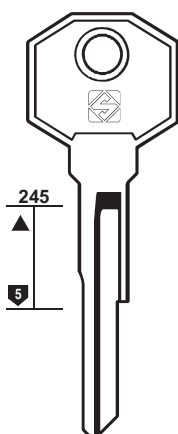

BUR5

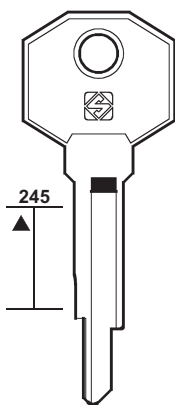

BUR12

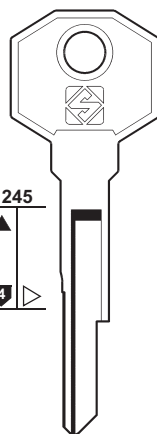

BUR19

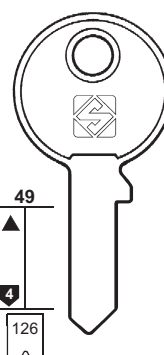

BUR3 **BUR3R**
BUR10R

M... 601-983



PER:
FOR:

BURG

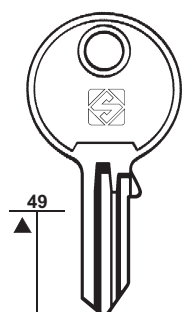

BUR9

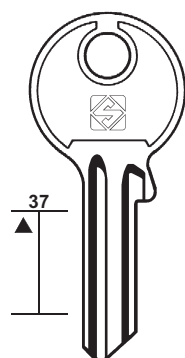

BUR15

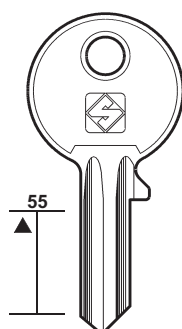

BUR16

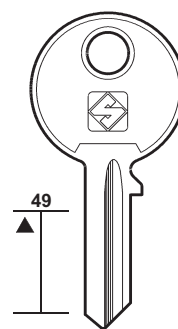

BUR17R



38

PER / FOR

BURG (D)
HOPPE
OTTO

- + ABUS (8)
- + HOPPE (93)
- + MELSMETALL (122)
- + OJMAR (134)
- + RONIS (147)
- + VIRO (187)
- + ZEISS-IKON (201)

PER:
FOR:

BURG

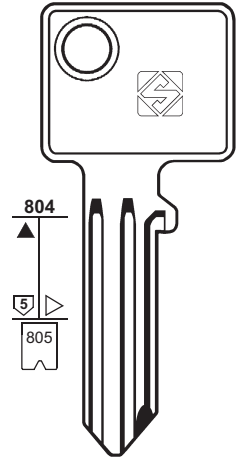
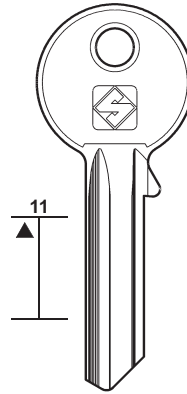
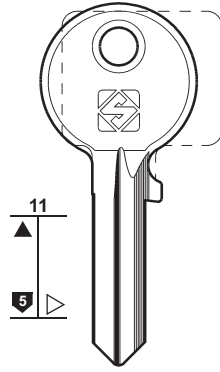
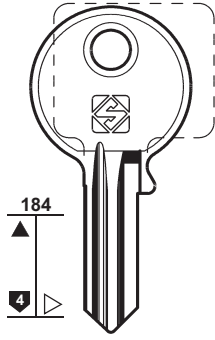

BUR22



BUR22R



● BUR23



BUR23R



BUR29

39R/68R



BUR18



BUR13

- (600/40) 123456
- (600/50) 123456
- (600/60) 123456



mm 30-35



mm 40

PER:
FOR:

BURG

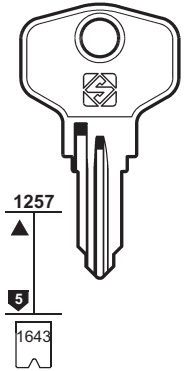
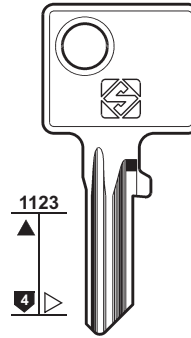
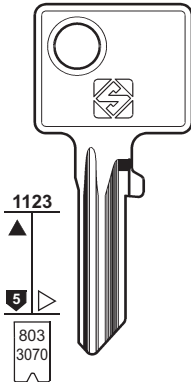
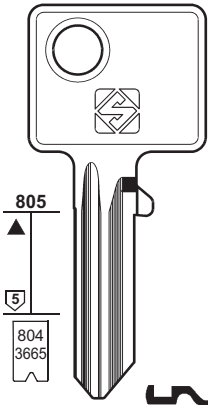

BUR14R

- ▲ ● BUR21
- (116/40)
- (116/50)
- (116/60)
- 123456



BUR21R



mm 50

- BUR20 BUR20R
- (116/30)
- 0-1-2-3-4-5
- 1-2-3-4-5-6



BUR26

- BUR24R
- 2W ... 1-246

HOPPE - OTTO

PER:
FOR:

BURG

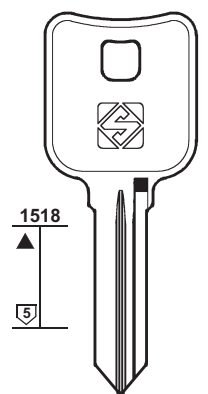
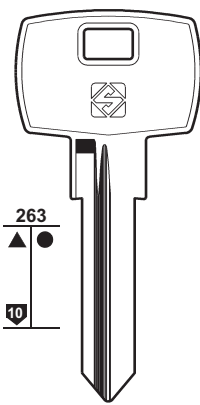
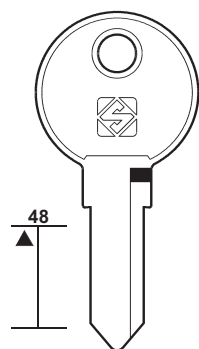
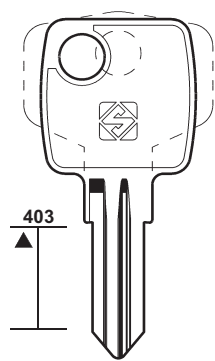

- BUR28R
- 34W

- BUR31 BUR31R

- BUR32
- 26W
- BUR34R

- BUR38

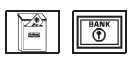

PER:
FOR:

BURG

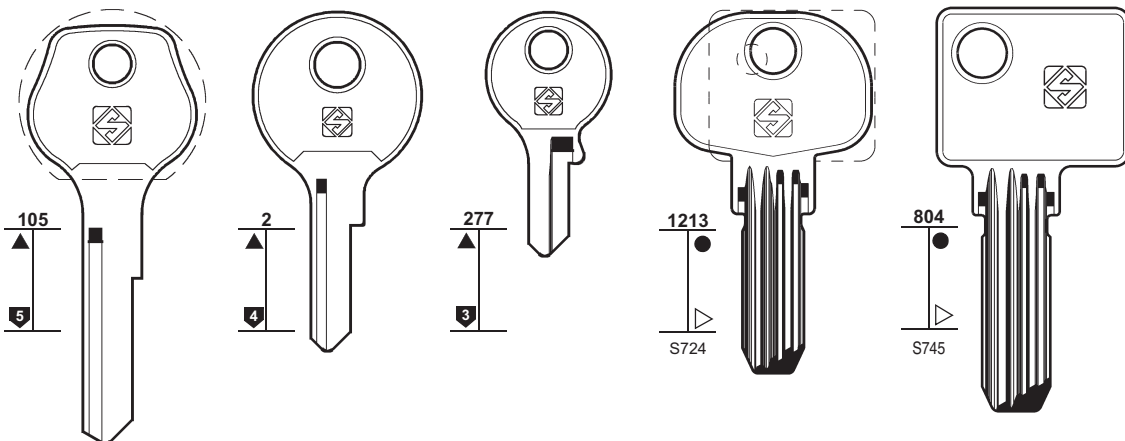

BUR57R
71R

BUR55R
77R

BUR56
405/20

BUR27
75W

BUR33
76W



39

PER / FOR

- BURG (D)**
 + ABUS (8)
 + HOPPE (93)
 + MELSMETALL (122)
 + OJMAR (134)
 + RONIS (147)
 + VIRO (187)
 + ZEISS-IKON (201)

PER:
FOR:

BUS

BUVA

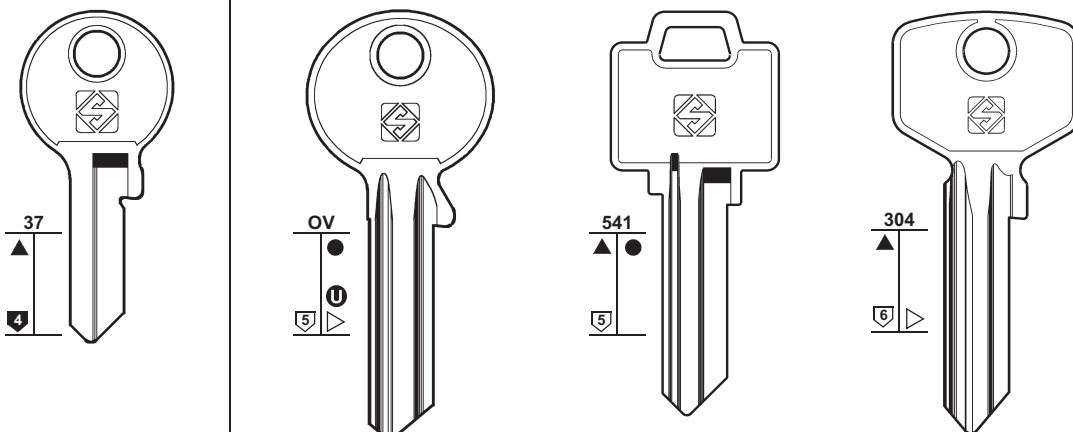

BUS1

BVA1 ▲ **BVA1R**

BVA3

BVA4

KROST

GERA - KALE

BUS (D)
KROST

BUVA (D)
GERA
KALE
+ PHAFFENHAIN (141)

BV (D)
CAS-CISMA (40)
FASEM (77)

BWS (GB)
CORBIN (53)

CAB (I)
+ CAS-CISMA (40)
+ SIMECA (155)
+ YALE (194)

CAF (I)

CAM (F)
ISEO (97)

PER:
FOR:

CAB

CAF

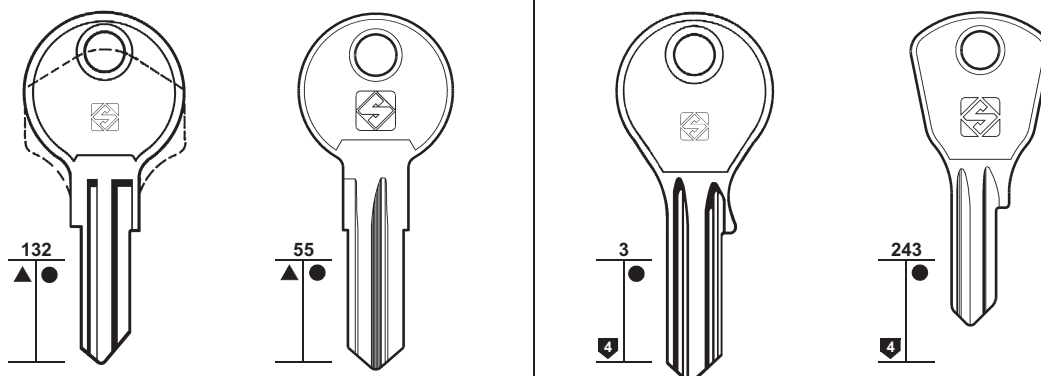

CAB1

CAB2R

CAF1 **CAF1R**

CAF2 **CAF2R**





40

PER / FOR

CANDA VEN CV (V)

CAP (F)

- 👁 CITY (51)
- 👁 KRV (105)
- 👁 PREFER (142)
- 👁 VACHETTE (184)

CARACAL (RC)

CARAT

- 👁 YALE (194)

CAROLI (I)

- 👁 MERONI (193)

C.A.R.S. (I)

- 👁 OMA (135)

CASAS (E)

- 👁 AGA (11)

CAS-CISMA (I)

- BV
- CAB
- DOMUS
- ETNA
- FTH
- GSA
- GUARDIAN
- LAPERCHÉ
- M
- MST
- SISO
- STIQAM
- STREMLER
- TECHNAL
- TESTA

CASI (D)

- 👁 SCHLECHTENDAHL (152)

CASIO (I)

- 👁 OLIVETTI (134)

CASH-BOX (D)

- + 👁 CLAUSOR (51)
- + 👁 KIFERM (106)

CASMA (I)

- 👁 CES (43)
- 👁 P.C. (140)

CATOR (F)

- 👁 RONIS (146-147)

CAVERS (F)

- 👁 AZBE (24)
- 👁 CISA (48)
- 👁 CITY (51)
- 👁 SPIDER (159)

CAYS (E)

PER:
FOR:

CANDA VEN CV

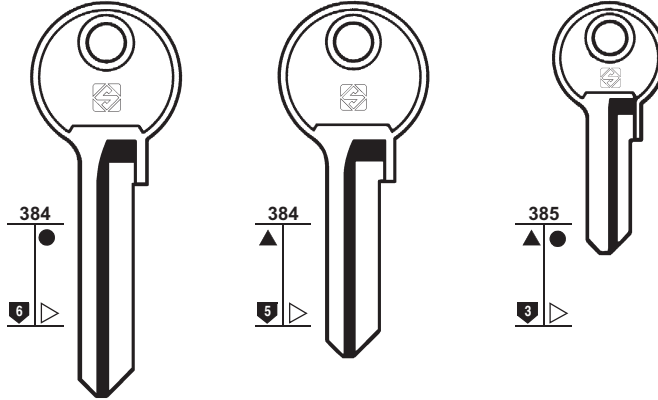

CV1

CV2

CV3



CARACAL

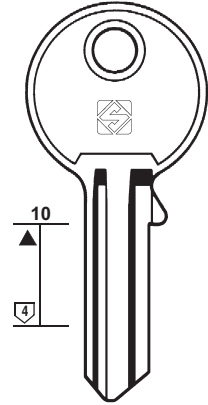

CAR1



PER:
FOR:

CAS-CISMA

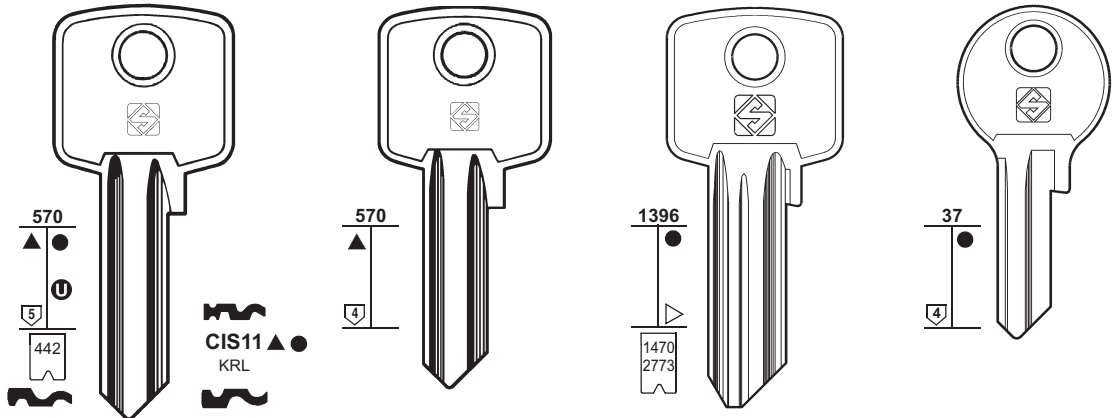

CIS5

- 1234567
- 123456789AB
- L 1001-2178
- L 14001-14500
- L 15001-18199
- 20001-20625

CIS11 ▲ ●
KRL

CIS5R ●

CIS8 ●

CIS6 ● CIS6R

CIS9
..... 12345678AB

CIS12
..... 12345678

CIS7

ETNA - FTH - GSA - LAPERCHÉ
STREMLER - TECHNAL

ETNA - GSA
LAPERCHÉ - STREMLER



PER:
FOR:

CAS-CISMA

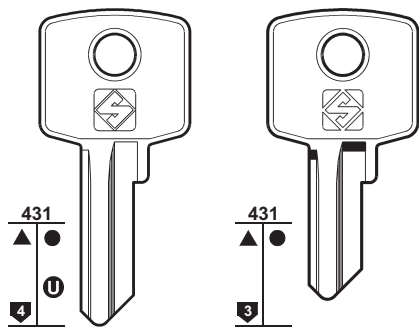

CIS2

CIS4 ▲ ● CIS4R ●

CIS1 CIS3



BV - CAB - DOMUS - GUARDIAN
M - MST - SISO - STIQAM - TESTA

CASH-BOX

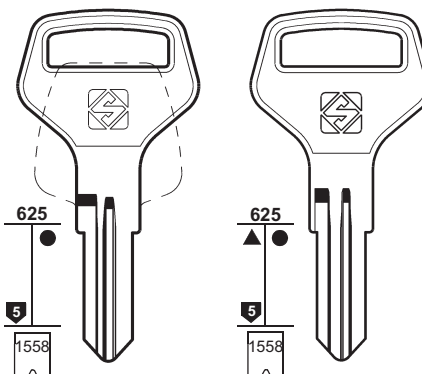

... 101-170
... 201-270

CAX1R



... 0-1-2
... 301-370

CAX2R



CAYS

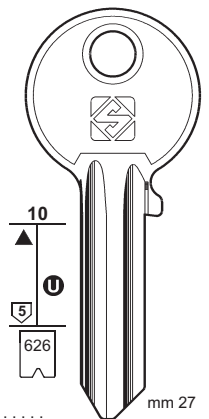

..... mm 27
0-1-2-3-4-5-6-7-8-9

⊕ CYS1 CYS1R ▲

PER: FOR:	CAYS	CCC	CEE	CEMA

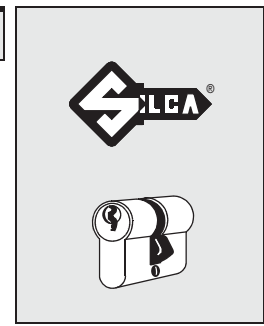

41

- PER / FOR
- CAYS (E)
 - CCC (IL)
 - CEE (P)
 - CCL (F)
CORBIN (55)
 - CEKA (D)
HUWIL (94)
 - CEMA (I)
ELFIN
LAMPA
 - CENTURY (GB)
ALLGOOD
 - CES (D)
BODA
ELZETT
FRECOV
HÄFELE
HANNO
JOSTA
KARDEX
KIND
KNAPP
MAUSER
NEMEF
OJMAR
SÄNTIS
STUV
VOKO
WASO
WECO

PER:
FOR:

CENTURY

	ALLGOOD			

PER:
FOR:

CES

ELZETT FRECOV HÄFELE HANNO JOSTA KARDEX KIND KNAPP MAUSER NEMEF OJMAR VOKO WASO WECO	BODA ELZETT FRECOV KNAPP	ELZETT FRECOV HÄFELE HANNO JOSTA KARDEX KIND KNAPP MAUSER NEMEF OJMAR SÄNTIS VOKO WASO WECO	BODA ELZETT FRECOV KNAPP	CE8 12345678 CE34 123456789 CE35 123456789 CE36 123456789	CE9 12345678 CE10	FRECOV HÄFELE HANNO JOSTA KARDEX KIND KNAPP MAUSER NEMEF OJMAR VOKO WASO WECO	BODA FRECOV KNAPP OJMAR	CE18 N... 1-50 ... 101-400	



42

PER / FOR

CES (D)
 BERRY
 BODA
 BOTT
 COMBA
 ELZETT
 FEFI
 FRECOV
 FUHR
 GIESCHE
 HÄFELE
 HANNO
 HÖHRMANN
 JOSTA
 KARDEX
 KIMA
 KIND
 KNAPP
 MAUSER
 MBB
 NEMEF
 OJMAR
 OTIS
 SÄNTIS
 SIEBAU
 SOLID
 SS
 STUV
 TORE
 TRITON
 VOKO
 WASO
 WECCO

PER:
FOR:

CES

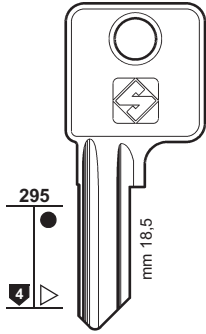

CE33

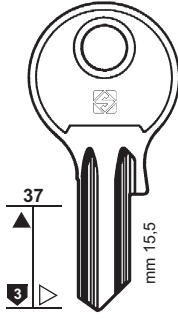

CE13
 ELZETT
 FRECOV
 HÄFELE
 HANNO
 JOSTA
 KARDEX
 KIND
 KNAPP
 MAUSER
 NEMEF
 OJMAR
 VOKO
 WASO

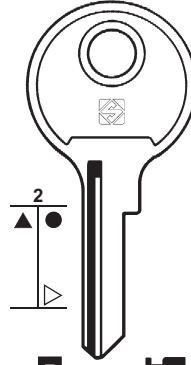

CE11 ▲ CE11R
 BOTT

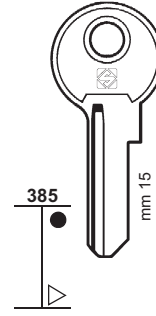

CE19
 CE19R

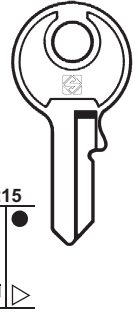

CE30
 CE30R

PER:
FOR:

CES

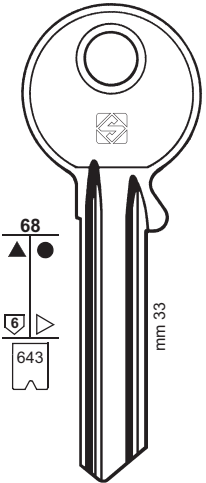

CE3 CE3R

 1-2-3-4-5-6-7-8-9-0
 BODA

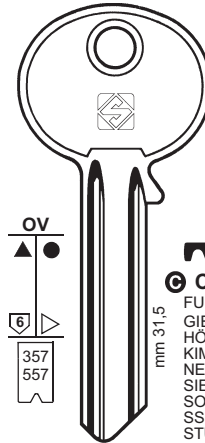

CE1
 FUHR
 GIESCHE
 HÖHRMANN
 KIMA
 NEMEF
 SIEBAU
 SOLID
 SS
 STUV

.....
 1-2-3-4-5-6-7-8-9-0
 A
 1-2-3-4-5-6-7-8

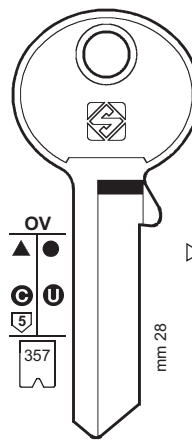

CE5

.....
 1-2-3-4-5-6-7-8-9-0
 BB 1-12000
 BBF 1-12000
 BT 1-12000
 TS 1-12000

CE2
 BERRY
 COMBA
 FEFI
 HÄFELE
 HÖHRMANN
 MBB
 NEMEF
 OTIS
 SÄNTIS
 SOLID
 STUV
 TORE
 TRITON

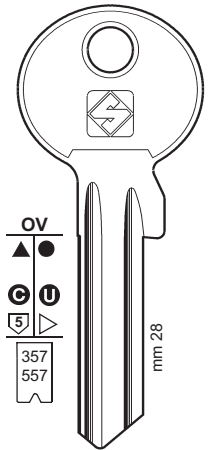

CE2X

PER:
FOR:

CES

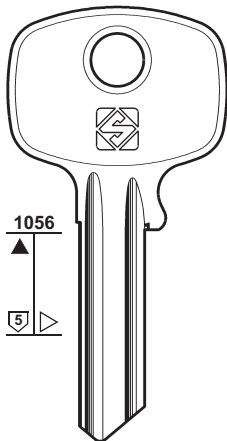

CE40

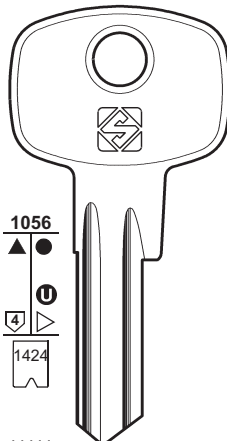

CE41

.....
1-2-3-4-5-6-7-8-9-0

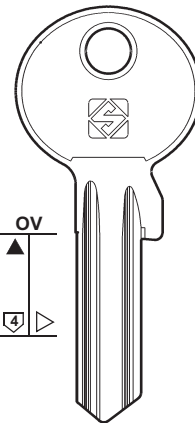

CE41X-OV

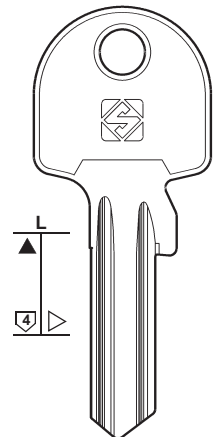

CE41XL

HÄFELE

PER:
FOR:

CES

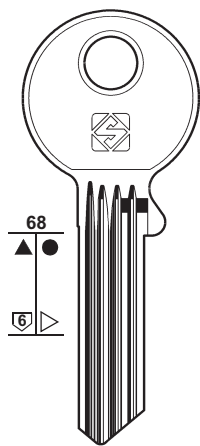

CE17XPS

CE17WPS

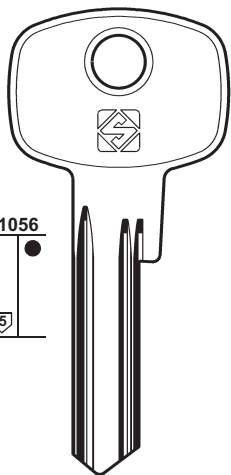

CE127
NEMEF

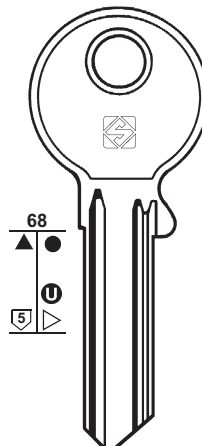

CE20

CE114
NEMEF



43

PER / FOR

CES (D)
BODA
CASMA
NEMEF
SPEEDAL

PER:
FOR:

CES

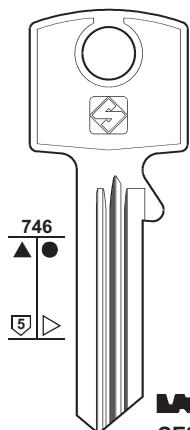

CE23R

CE28

CE31

CE24R

CE32R

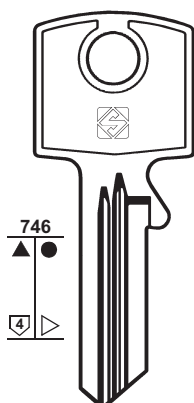

CE25R

CE27 CE26R

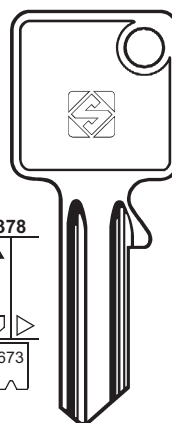

CE12
..... 1234567890

CASMA - SPEEDAL

PER:
FOR:

CES

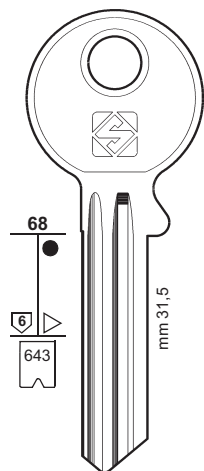

K CE15 CE39
 TB CE16

15 CE14-15

16 CE14-16

17 CE14-17

18 CE14-18

25 CE14-25
..... 1234567890

26 CE14-26

27 CE14-27

28 CE14-28

35 CE14-35

36 CE14-36

37 CE14-37

38 CE14-38

45 CE14-45

46 CE14-46

47 CE14-47

48 CE14-48

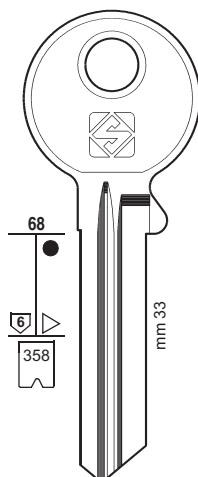

15 CE22-15
 16 CE22-16
12..... 1-100000

17 CE22-17

18 CE22-18

25 CE22-25

26 CE22-26

27 CE22-27

28 CE22-28

35 CE22-35

36 CE22-36

37 CE22-37

38 CE22-38

45 CE22-45

46 CE22-46

47 CE22-47

48 CE22-48

BODA

BODA



44

PER / FOR

CES (D)
BODA
THÖMEE

PER:
FOR:

CES

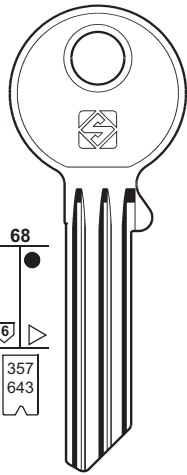

.....
1-2-3-4-5-6-7-8-9-0

CE130-1 C/2	CE130-2 B/2	CE130-3 B/1	CE130-4 C/4	CE130-5 A/4	CE130-6 A/5	CE130-7 C/5
CE130-8 C/1	CE130-9 A/2	CE130-10 D/1	CE130-11 A/34	CE130-12 B/3	CE130-13 X/678	CE130-14 1/68
CE130-15 4/67	CE130-16 4/68	CE130-17 AB5	CE130-18 B1/5	CE130-19 C1/5	CE130-20 AD1	CE130-21 AD4
CE130-22 A1-5	CE130-23 AB1-3	CE130-24 D1-5	CE130-25 D/2	CE130-26 D/5	CE130-27 D/4	CE130-28 A/3
CE130-29 C/34	CE130-30 C/3	CE130-31 B/34	CE130-32 B/5	CE130-33 B/4	CE130-34 D/3	CE130-35 A/1

BODA - THÖMEE

PER:
FOR:



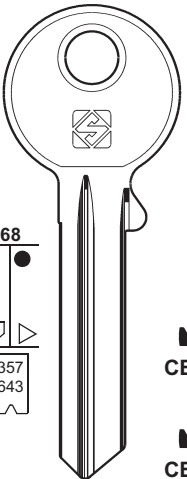





CES

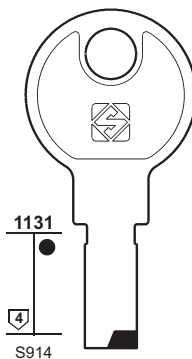

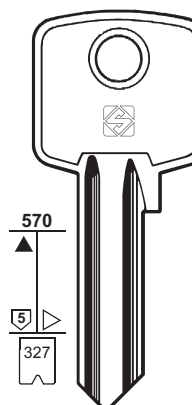
.....
1-2-3-4-5-6-7-8-9-0

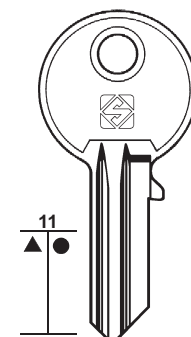

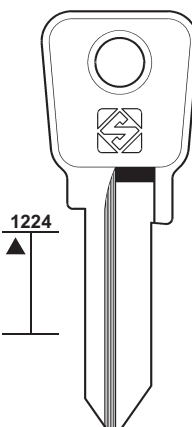



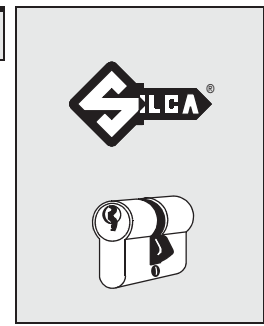



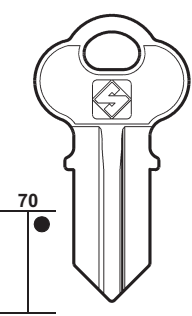

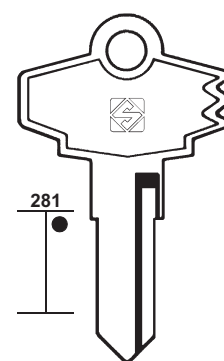

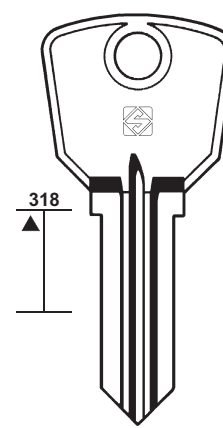

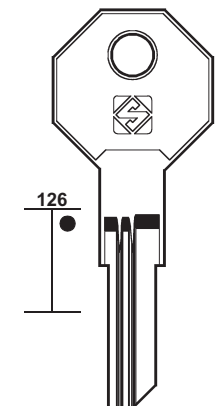
CE129-1 R/8	CE129-2 Z/568	CE129-3 1/678	CE129-4 2/568	CE129-5 R/7	CE129-6 Z/68	CE129-7 G/56
CE129-8 G/68	CE129-9 R/R	CE129-10 G/5	CE129-11 G/6	CE129-12 3/567	CE129-13 G/67	CE129-14 3/R
CE129-15 3/568	CE129-16 Y/567	CE129-17 G/57	CE129-18 2/R	CE129-19 1/56	CE129-20 Y/68	CE129-21 1/67
CE129-22 3/68	CE129-23 G/678	CE129-24 3/58	CE129-25 3/678	CE129-26 4/578	CE129-27 4/568	CE129-28 3/57
CE129-30 4/678	CE129-31 3/578	CE129-32 2/57	CE129-33 Z/67	CE129-34 G/578	CE129-35 1/567	CE129-36 1/G
CE129-38 X/R	CE129-39 4/78	CE129-40 1/568	CE129-41 G/8	CE129-42 G/7	CE129-43 X/6	CE129-44 4/56
CE129-46 Z/7	CE129-47 2/56	CE129-48 G/58	CE129-49 2/67	CE129-50 2/68	CE129-51 4/567	CE129-52 4/G
CE129-54 X/G	CE129-55 3/78	CE129-56 Z/5	CE129-57 2/G	CE129-58 2/578	CE129-59 Z/G	CE129-60 Z/56
CE129-62 X/58	CE129-63 Y/67	CE129-64 4/R	CE129-65 Y/56	CE129-66 Z/567	CE129-67 Y/G	CE129-68 Z/78
CE129-70 2/58	CE129-71 X/7	CE129-72 1/58	CE129-73 4/57	CE129-74 X/67	CE129-75 Y/6	CE129-76 3/56
CE129-78 Y/57	CE129-79 Y/8	CE129-80 Z/8	CE129-81 2/567	CE129-82 X/8	CE129-83 Y/58	CE129-84 3/67
CE129-86 Z/6	CE129-87 3/G	CE129-88 2/678	CE129-89 X/5	CE129-90 R/6		

BODA - THÖMEE











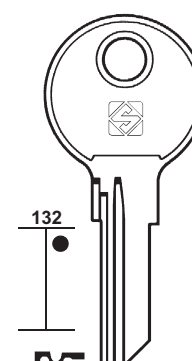

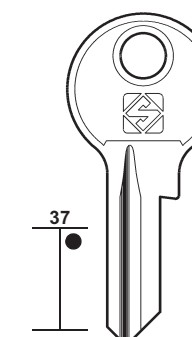

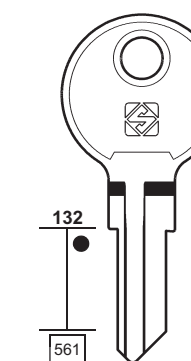

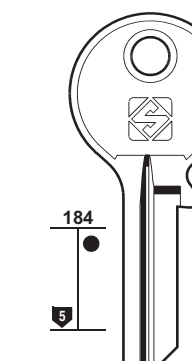
PER: FOR:	CES	CHAVO	CHEK	CHELIABINSK
	 <p>1131 S914</p> <p>MS... 1-20</p> <p>CE131</p>  	 <p>570</p> <p>327</p> <p>CHV1 CHV1R</p>  	 <p>11</p> <p>CK1</p>  <p>CHEYLOCK</p> 	 <p>1224</p> <p>CLK1</p> 



45

PER: FOR:	CHICAGO			
	 <p>70</p> <p>CH1</p> 	 <p>281</p> <p>CH2</p> 	 <p>318</p> <p>CH3</p> 	 <p>126</p> <p>CH4</p> 
	<p>CH5</p> 	<p>CH6</p> 	<p>CH7</p> 	<p>CH8</p> 
	<p>CH15</p> 	<p>CH7R</p> 	<p>ILLINOIS - ODA</p> 	
	<p>FORT</p> 		<p>STEELCASE</p> 	

PER / FOR
CES (D)
CEV (I) IDRO-STOP (94)
CF (F) FTH (81)
CFP (D) WILKA (191)
CHANGE-O-MATIC (F) CORBIN (55)
CHAVO (P) + CISA (48) + SOFI-SONAFI (157)
CHEK (HK) CHEYLOCK
CHELIABINSK (RUS)
CHEYLOCK (HK) CHEK (45)
CHG (F) GABON (84)
CHICAGO (USA) FORT ILLINOIS ODA STEELCASE

PER: FOR:	CHICAGO			
	 <p>132</p> <p>CH18</p> 	 <p>37</p> <p>CH11</p> 	 <p>132</p> <p>561</p> <p>CH19</p> 	 <p>184</p> <p>CH27</p> 
	<p>CH12</p> 	<p>CH10</p> 	<p>CH13</p> 	<p>CH14</p> 
	<p>CH11 FR</p> 	<p>CH24R</p> 	<p>YA18</p> 	<p>CH20</p> 
	<p>STEELCASE</p>	<p>LL... 1-225</p>	<p>FL... 201-240</p> <p>UM... 226-425</p> <p>LL... 226-450</p> <p>... 500-550</p> <p>... 600-650</p>	



46

PER / FOR

CHICAGO (USA)

ACE
 ADEMCO
 AGA
 ALPHA
 EURO LOCKS
 FORT
 GEM
 IFAM
 L & F

CHRIST (D)

DOM (60)
 HUWIL (94)

CHSS (RC)

CHUBB (GB)

+ AVA-CHUBB (24)

CIAL (BR)

CIB (F)

FTH (81)
 OMIV (136)
 PREFER (142)
 UCEM (175)

CIBC (I)

CISA (50)
 FTH (82)

CIC (I)

BASI (28)
 CORNI (55)

CIEF (F)

CIELS (I)

PER:
FOR:

CHICAGO

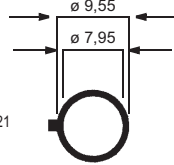
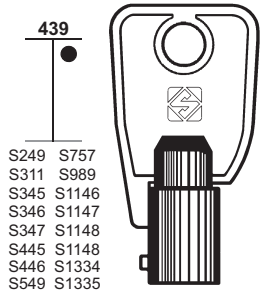

... 1-999
 2001-2100
 0123
 7654321
 7654321
 7654321
 1234567
 280001-285000
 320001-326000
 24568ABCDEFGHIJKLMNO

CH9T

..... HD 0001-9400
 HD 0001-9400
 HMC 00001-31000
ACE - ADEMCO - AGA - ALPHA
EURO LOCKS - FORT
GEM - IFAM - L & F

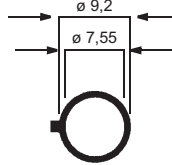
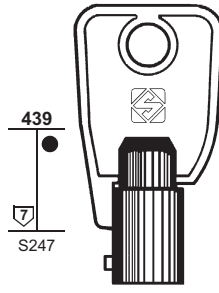

CH16T

..... 7-6-5-4-3-2-1

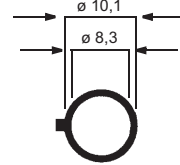
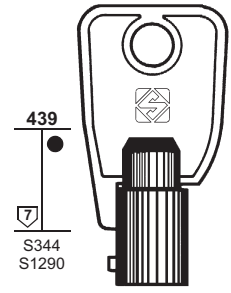

CH17T

..... 123456
 X123456

PER:
FOR:

CHSS

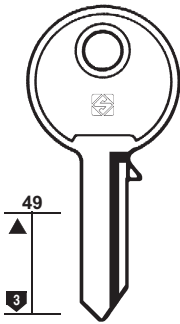

CHS1



mm 30

CHUBB

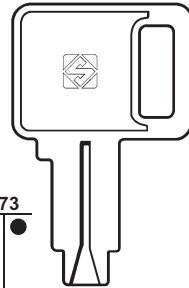

CHU5



1-2-3-4-5

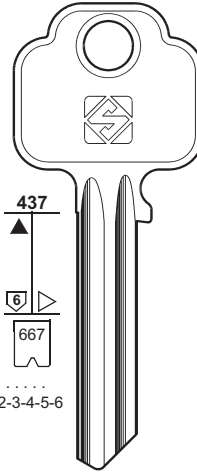

CHU6

1-2-3-4-5-6

CIAL

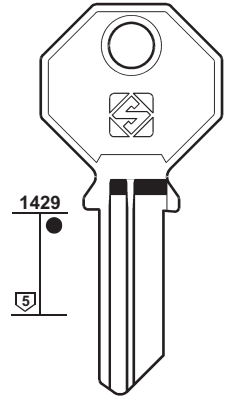

CIA1

PER:
FOR:

CIEF

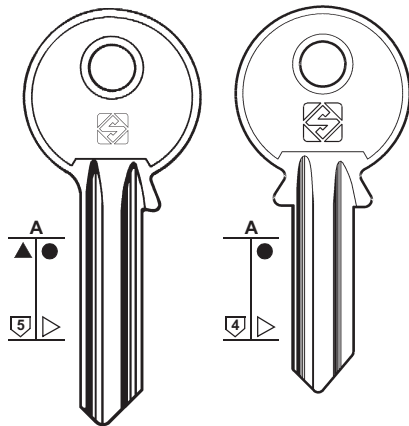

FEB2

● **FEB2R**

FEB1

FEB1R

CIELS

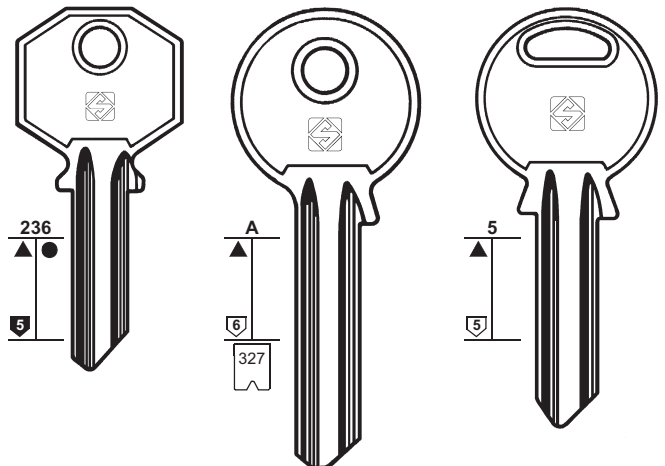

CLS1

CLS242

● **CLS3**

● **CLS220**

CLS2

1-2-3-4-5-6



PER: **CIERRA SOLA**
FOR:

CIFIAL

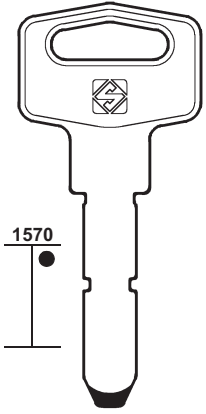

CRL1

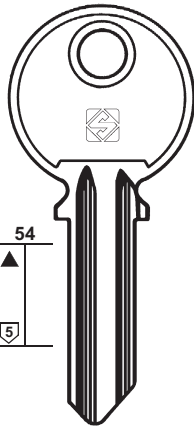

CF1 **CF1R**

CF2 **CF2R**

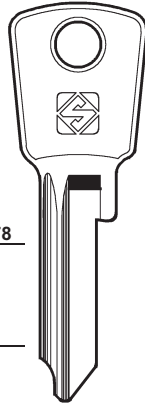

CF3

LE FEBURE

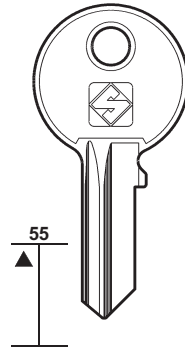

CF4



47

PER / FOR
CIERRA SOLA (RA)

CIFIAL (P)
LE FEBURE

CIGNO (I)
CISA (50)

CILA-GENTILI (I)

CINA (RC)
SHANGHAI
+ SHANGHAI (153)

PER:
FOR:

CILA-GENTILI

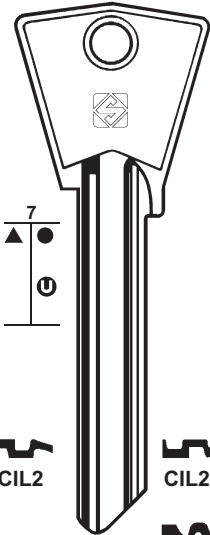

CIL2 **CIL2R**
CIL6

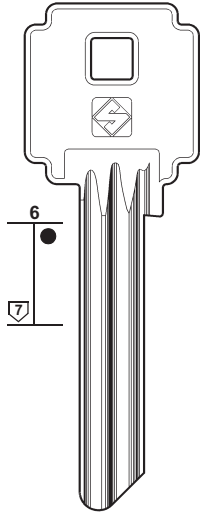

CIL7

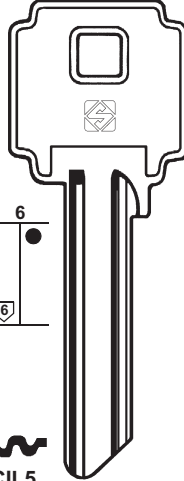

CIL5 **CIL1** **CIL1R**

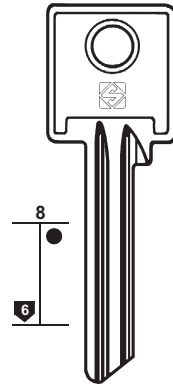

CIL3



PER:
FOR:

CINA

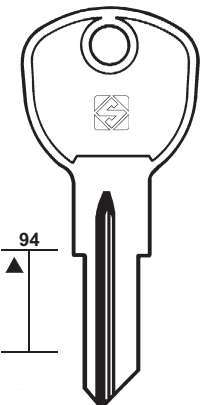

RC1R

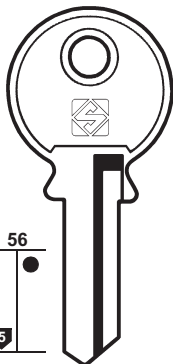

A303

C303

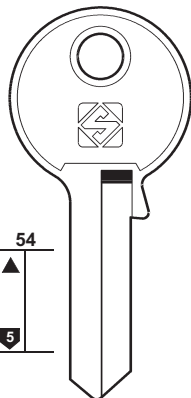

AS1



mm 45

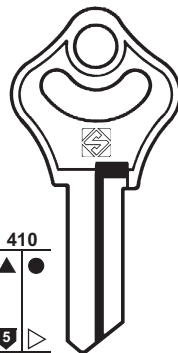

SG808 **SG808R**



SHANGHAI

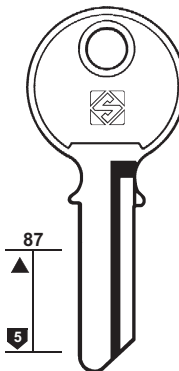

SG1



SHANGHAI



48

PER:
FOR:

CINA

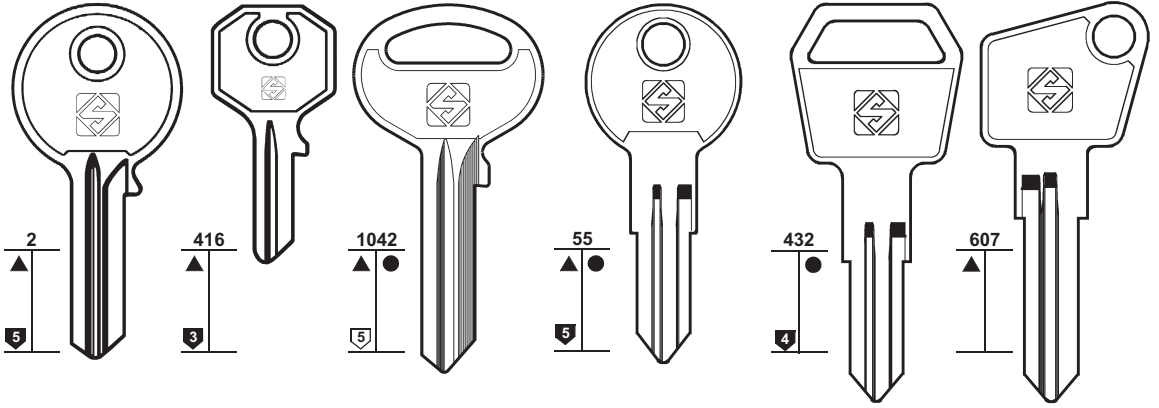

454



C555



555



RC3R ▲ RC4

ALI - EIKO



RC5



● RC5R



RC6



RC6R



RC7R



PER / FOR

CINA (RC)

555
ALI
EIKO
+ SHANGHAI(153)

CISA (I)

ABUS
ALA
ALF
BRICARD
CAVERS
CHAVO
DOBUS
ESCO
ESSENDIA
GEFI
GETE
GEVY
GTV
ITO
LOGO
NB
SCHÜCO
STANDARD
TIEFENTHAL
TZAFRER
UNIFERRO
+ ABUS (6-7-8-10)
+ ALA (13)

PER:
FOR:

CISA

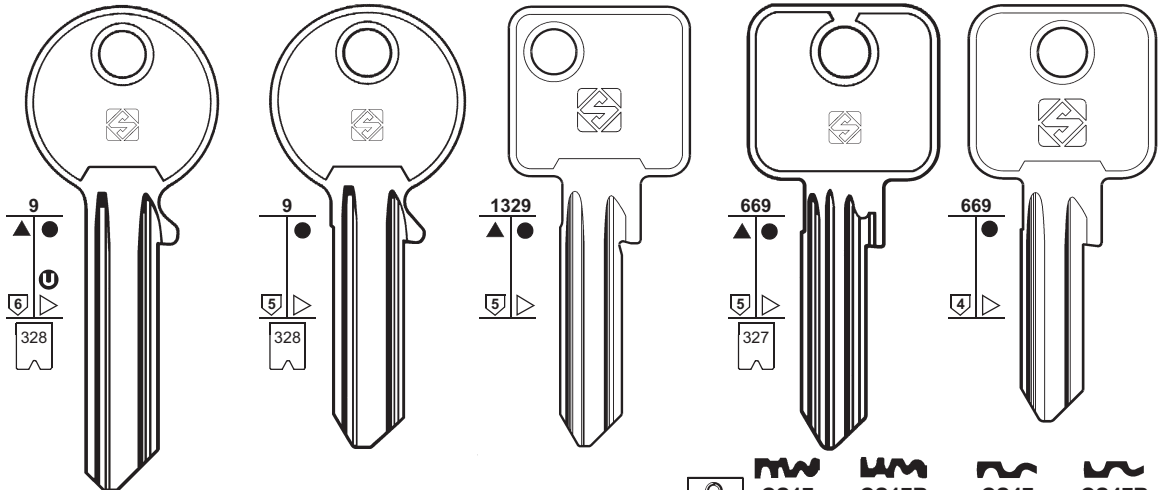

● CS501R



mm 70



CS501

..... 1-2-3-4-5



CS500R



CS500

..... 1-2-3-4-5



CS85

ABUS



CS17

mm 50-55-60-65
70-75-77-84-94



mm 50-60



CS17R

..... 1-2-3-4-5-6



ALA



CS47



mm 50-60



CS47R



mm 50-60

PER:
FOR:

CISA

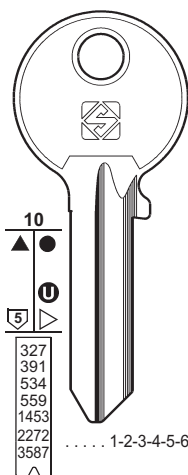

..... 1-2-3-4-5-6



mm 50-60

AY 1-6032
BA 1-6032
BB 1-6032
BC 1-6032
BD 1-6032
BJ 1-6032
BK 1-6032
BL 1-6032
BM 1-6032
BN 1-6032
BP 1-6032
BQ 1-6032
BR 1-6032
BS 1-6032
BT 1-6032
BU 1-6032
BY 1-6032
SA 1-6032
SB 1-6032
..... 123456
..... 123456789

CS206
ABUS
ALF
CHAVO
ESCO
ESSENDIA
GEFI
GETE
GTV
ITO
NB
SCHÜCO
STANDARD
TIEFENTHAL
UNIFERRO
P.....
00000-02360
E..... 1234567890ABCDEFGHI
G28D



CS13

BRICARD



CS13R

BRICARD



CS14



CS14R



CS15



CS15R



CS18

LOGO



CS18R

LOGO



CS68



CS24

LOGO



CS24R

LOGO



CS88



CS27

ABUS

CAVERS

ESCO

ESSENDIA

GEFI

GETE

GTV

NB

SCHÜCO

STANDARD



CS31

CS31R

CS138

G08D

CS38

CS38R

CS142

CS44

CS44R

CS143



CS138

G08D

CS142

CS143

CS147

CS147

CS147

CS147

CS147

CS147

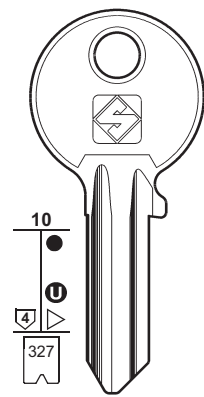

..... 1-2-3-4-5-6



DOBUS - GEVY - TZAFRER



CS16

LOGO

..... 1-2-3-4-5-6



CS25

LOGO

CS30

CS30R



CS34

CS34R



CS36

CS37

CS37R



CS42

G28D

CS105

CS105

CS105



CS16R

LOGO

..... 1-2-3-4-5-6



CS25R

LOGO

CS30R

CS30R



CS34R

CS34R



CS41

CS37R

CS37R



CS43

G16D

CS105

CS105

CS105

PER:
FOR:

CISA

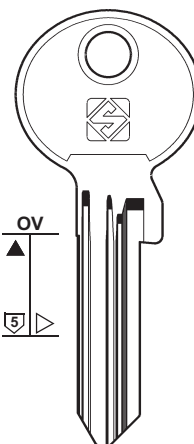
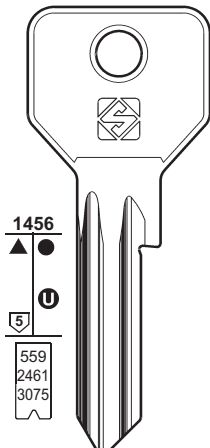
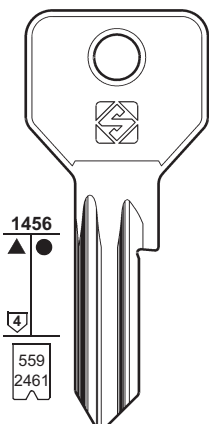
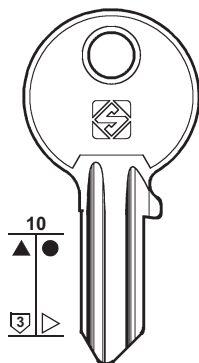

CS4 ●CS4R



CS120

..... 1-2-3-4-5-6-7-8
..... (C 2000) 1-2-3-4-5-6-7-8



⊖ CS119 CS152 ●

..... 0-1-2-3-4-5-6-7-8 R027
..... 1-2-3-4-5-6-7-8
..... (C 2000) 1-2-3-4-5-6-7-8



CS13X CS52X ●

BRICARD G14D



●CS66



●CS120R



▲●CS119R



49

PER / FOR

CISA (I)

ABUS

BRICARD

ESLA

JPM

+ ● ABUS (6-7-8-10)

+ ● ALA (13)

PER:
FOR:

CISA

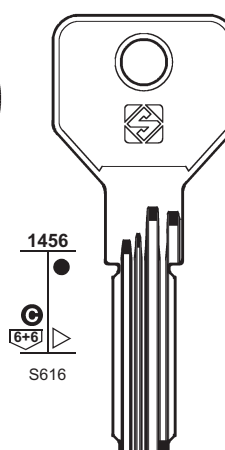
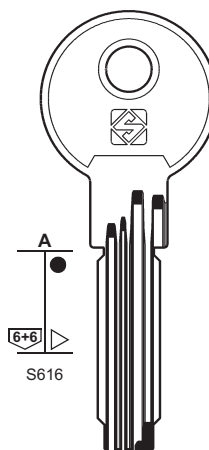
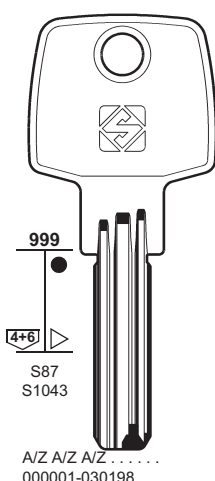
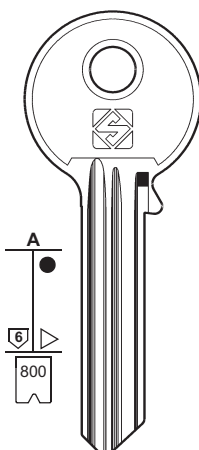
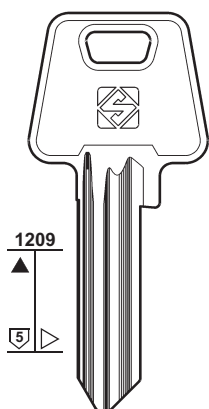

CS61

JPM



CS121

..... 0-1-2-3-4-5-6-7-8-9

ESLA



CS48



ABUS
BRICARD



⊖ CS70 (W60)

..... AM 1-38832 AM



ASIX



CS146

..... AM 1-38832 AM



ASIX

PER:
FOR:

CISA

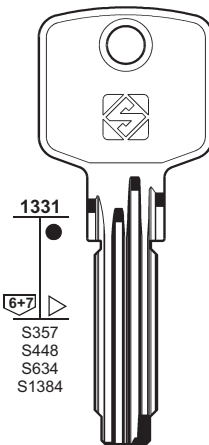

..... (XN008710) 1-11808
..... (XN005710) 1-38832
..... 900001-944826



CS144

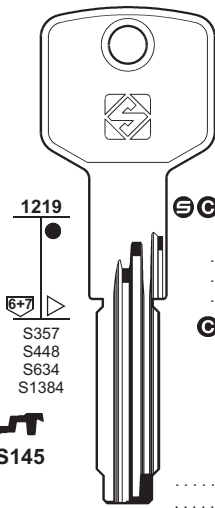

..... (XN008710) 1-11808
..... (XN005710) 1-38832

CS145



CS139

..... (XN008710) 1-11808
..... (XN005710) 1-38832

⊖ CS62 (W08)

..... (XN008710) 1-11808
..... (XN005710) 1-38832
..... 900001-944826

⊖ CS115 (W05)

BRICARD



CS141

..... (XN008710) 1-11808
..... (XN005710) 1-38832



CS140

..... (XN008710) 1-11808
..... (XN005710) 1-38832

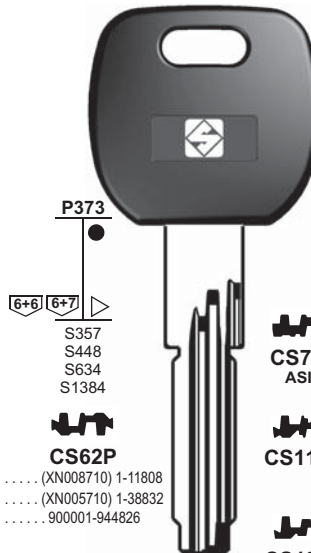

..... (XN008710) 1-11808
..... (XN005710) 1-38832
..... 900001-944826



CS139P



CS70P
ASIX



CS116P



CS139P



50

PER / FOR

CISA (I)

- ABUS
- ALA
- BASI
- BATU
- CIBC
- CIGNO
- CITY
- IFAM
- KUNERT
- LOGO
- + ABUS (6-7-8-10)
- + ALA (13)

PER:
FOR:

CISA

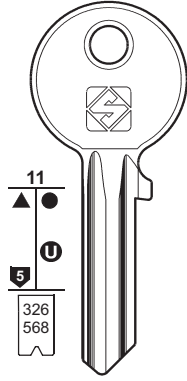

▲● CS21 ●CS21R
..... 1-2-3-4-5-6

⊖ CS7 CS7R
A..... 1-01321
..... 1-2-3-4-5-6



mm 40

BATU - CIBC
IFAM - KUNERT - LOGO

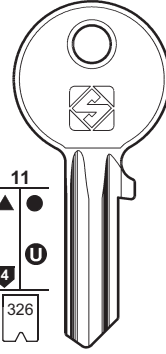

CS6 CS6R ▲●
..... 1-2-3-4-5-6
EA... 1-738



mm 30

ABUS

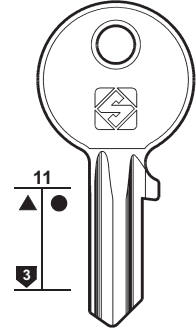

CS5 CS5R ●

LOK 2000
ABUS

PER:
FOR:

CISA

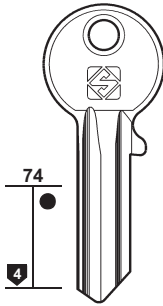

CS22
LOGO

▲● CS8



mm 30

IFAM

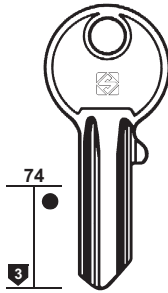

CS22R
LOGO

CS8R



mm 20-25

CIGNO

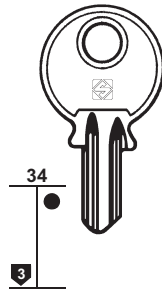

CS9 CS9R



mm 15

ABUS - ALA

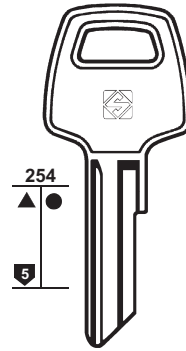

CS12 CS12R



CS10 CS10R ●

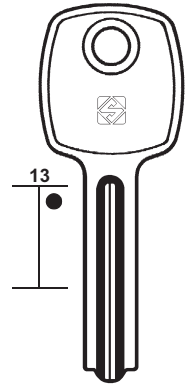

CS11



PER:
FOR:

CISA

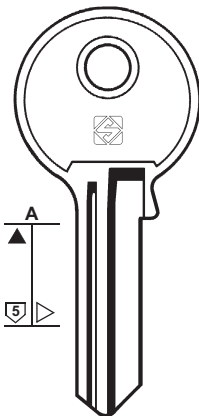

CS33 CS33R



BASI

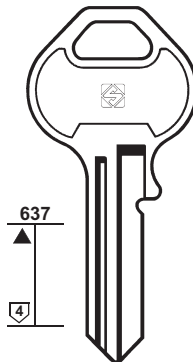

CS32 CS32R



BASI - CITY

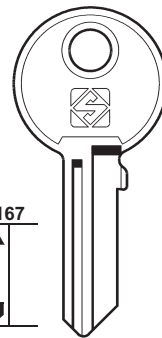

CS19 CS19R



BASI

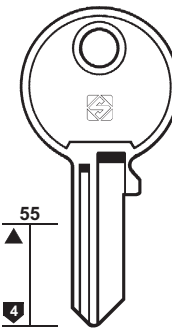

CS26

CS26R





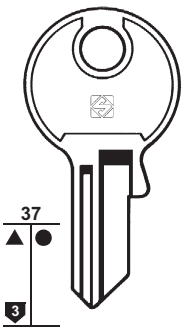





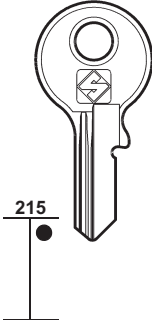
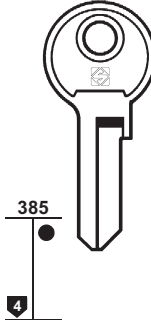
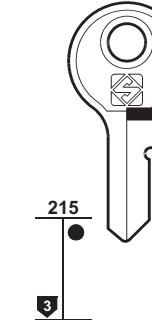
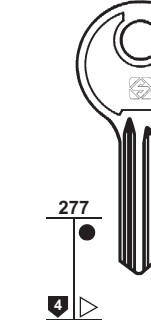
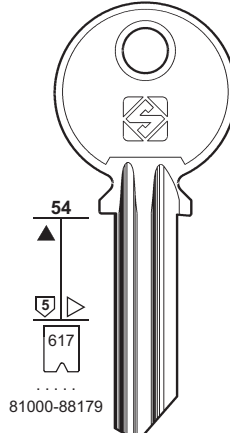

CITY



● CS27

CS27R





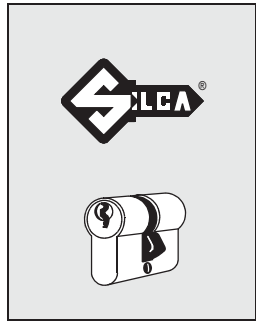

CISA				CITY
				
215	385	215	277	54
				
CS45	CS20	CS23	CS28	CA15
CS45R	CS20R	CS23R	CS28R	
				
BASI - IFAM				





51

PER / FOR

CISA (I)
 BASI
 IFAM
 +  ABUS (6-7-8-10)
 +  ALA (13)

CITY (F)
 ATP
 CAP
 CAVERS
 FO
 PROTEC
 QCP
 SIAM
 SOS
 VIP
 ZENITH
 +  BUGA (36)
 +  CISA (50)
 +  FTH (82)











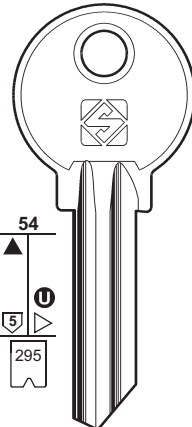
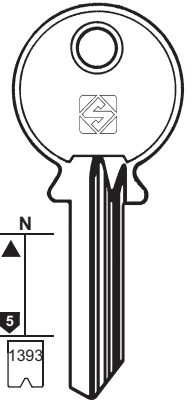

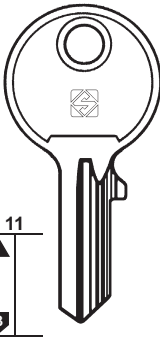

CKS (D)
 YALE (193)





CLAUSOR (E)
 BRABANTIA
 CASH BOX
 ELSET
 +  ME-FA (122)





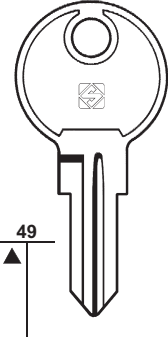
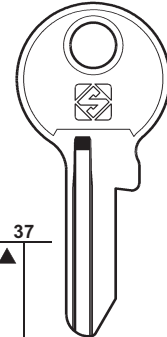





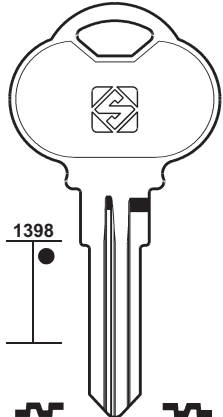
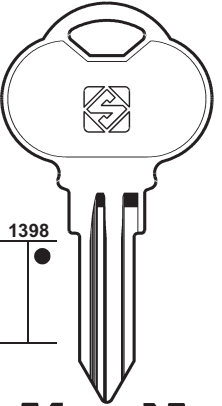

CLUB (USA)

CODEM (F)
 FTH (83)

CODKEY (IL)
 SPIDER (159)

CITY					
					
54	N	274	11	215	
					
295	1393				
					
CA2R	CA2	CA1	CA3	CA4	CA5
160... 000-999 16... 1000-6288	 25001-25075			
ATP - CAP - FO PROTEC - QCP - SIAM SOS - VIP - ZENITH		CAVERS	CAVERS	CAVERS	CAVERS

CLAUSOR	
	
49	37
	
CR2R	CR5R
	
BRABANTIA CASH BOX - ELSET	

CLUB			
			
1398	1398		
			
CLU1	CLU1R	CLU4	CLU4R
			
CLU2	CLU2R	CLU5	CLU5R
			
CLU3	CLU3R		



52

PER / FOR

COLE (USA)
ROYAL

COLE-HERSEE (USA)
YALE (194)

COLL (BY)

COLOMENCA (E)
AGA (11)

COMBA (D)
CES (42)
KFV (105)
TOK-WINKHAUS (170)

CONCEPT (BR)

CORBIN (I)
MERMIER
OAL
POPLOCK

PER:
FOR:

COLE

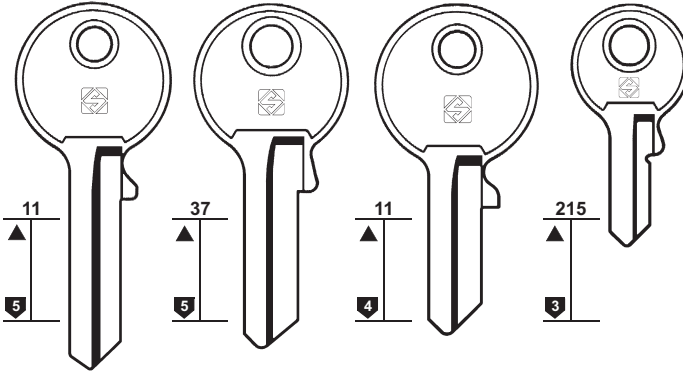

COL1



COL2



COL3



COL4



ROYAL

COLL

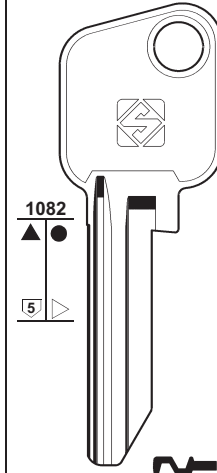

CLL1

CONCEPT

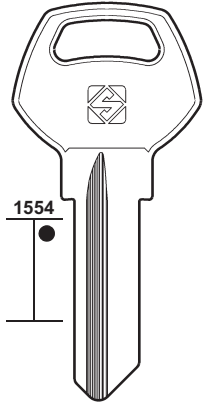

CNP1R

PER:
FOR:

CORBIN (I)

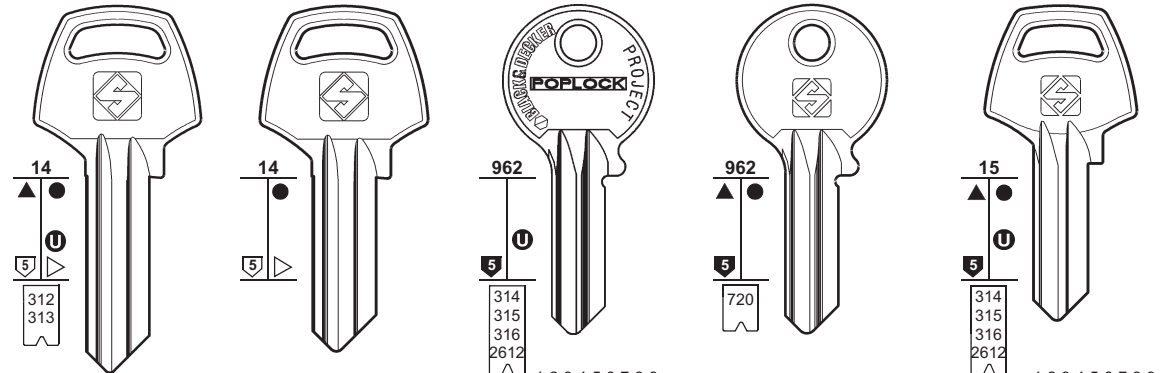

CB1



CB1R



CB2



CB2R



CB3-OR



CB80



CB3



CB3R



mm 26-45-50-60

MERMIER - OAL



mm 23

OAL



mm 21-40

OAL

PER:
FOR:

CORBIN (I)

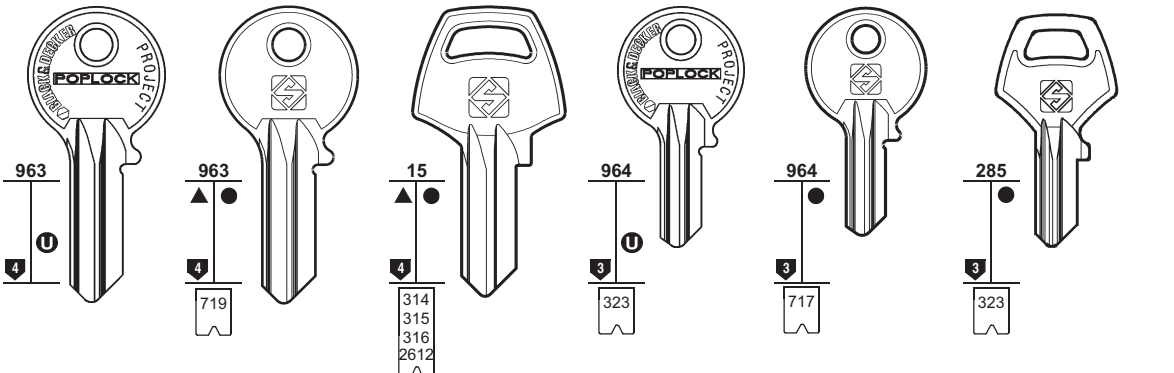

CB4-OR



CB81



CB4



CB4R



CB9-OR



CB79



CB9



mm 17,5

POPLOCK



mm 11,5-20-25

POPLOCK

PER:
FOR:

CORBIN (I)

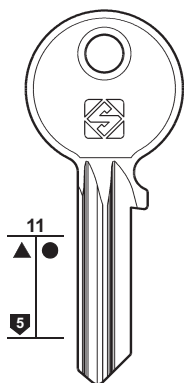

CB85

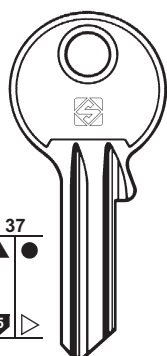

CB15
025

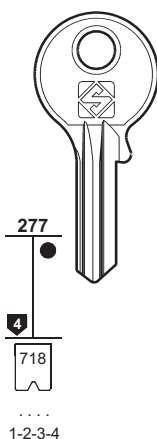

CB70

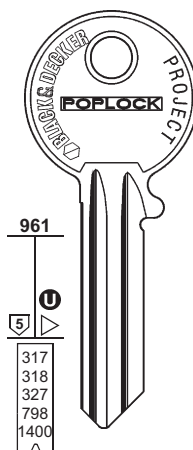

CB6-OR

POPLOCK



53

PER / FOR

CORBIN (I)

ALUNORM
BWS
CRC-CAMBÒA
DOM
ESCO
EURONORM
FEB
HEGO
HESTE
ISSERSTEDT
KAWE
LITTO
MERMIER
MUKRA
NEMEF
NOVOFERM
POPLOCK
STREMLER
SUL
TESIO
THÒNE
VERSCO
WÜRTH
ZEÇE

PER:
FOR:

CORBIN (I)

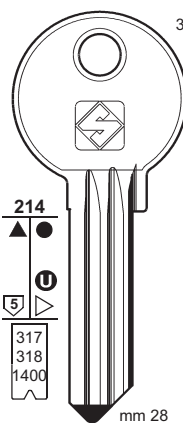

365 **CB6**
ALUNORM
CRC-CAMBÒA
DOM
ESCO
EURONORM
FEB
HEGO
HESTE
ISSERSTEDT
KAWE
LITTO
MERMIER
MUKRA
NEMEF
NOVOFERM
STREMLER
SUL
THÒNE
VERSCO
WÜRTH
ZEÇE

..... 1-2-3-4-5-6-7-8-9
..... 0-1-2-3-4-5-6-7-8
..... 8-7-6-5-4-3-2-1-0
..... 012345678
..... 123456
DX 123456
..... 123456789
..... 876543210

BWS

CB6R
 CB16
A1
 CB17
 CB19
B1
 CB32
 CB42
 CB43R
 CB78R

CB95R
 CB96R
 CB99R
 CB100R
 CB101R

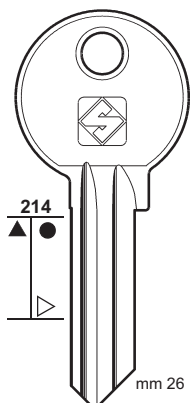

CB5 **CB5R**

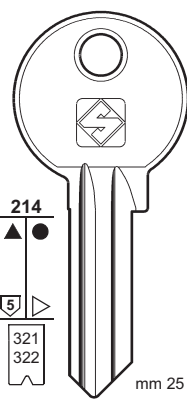

CB8
..... 2-3-4-5-6-7-8
..... 1-2-3-4-5-6-7-8-9

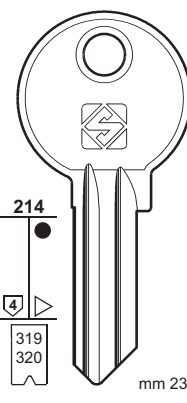

CB7 **CB7R**
..... 1-2-3-4-5-6-7
..... 2-3-4-5-6-7

ESCO - EURONORM
KAWE - MUKRA

PER:
FOR:

CORBIN (I)

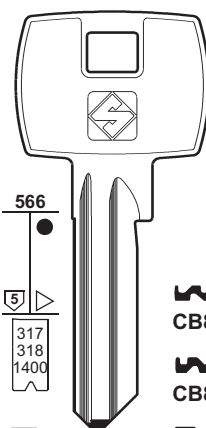

CB89R

CB88R

CB31

CB84
..... 1-2-3-4-5-6-7

CB30

CB30R

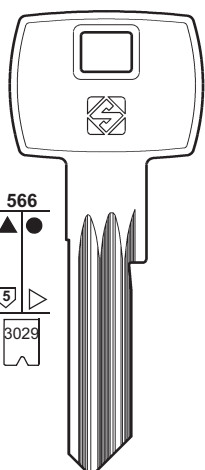

CB90R

CB86
..... 1-2-3-4-5-6-7

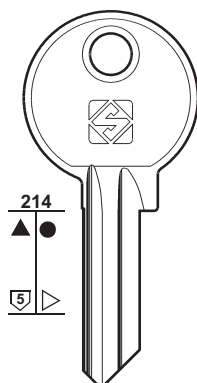

CB21

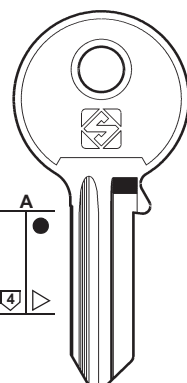

CB83

TESIO





54

PER / FOR

CORBIN (I)

CORBIN (AUS)
LANE

CORBIN (USA)
SKILMANN

PER:
FOR:

CORBIN (I)

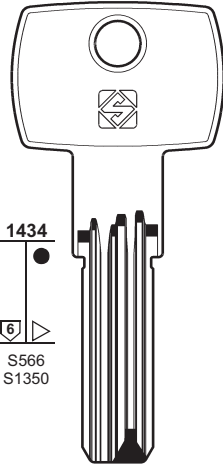

1434
6
S566
S1350

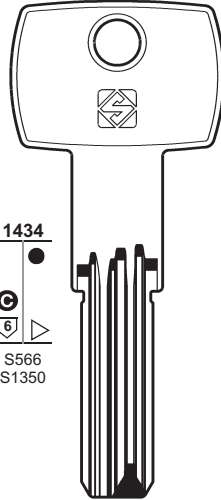

1434
6
S566
S1350

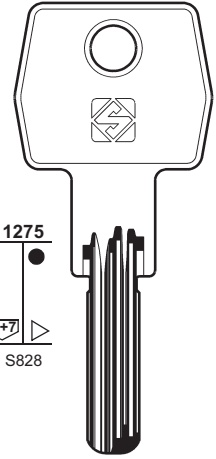
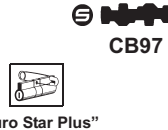

1275
6+7
S828



PER:
FOR:

CORBIN (USA)

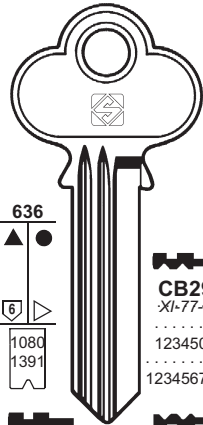

636
6
1080
1391



CB12



CB12R

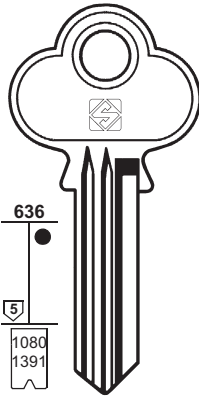

636
5
1080
1391

CB29
XI-77-6
1234506
123456789



CB29R



CB82



CB11

XI-77-5
1234567890



CB11R

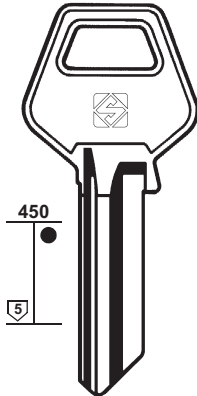

450
5
1080
1391



CB18

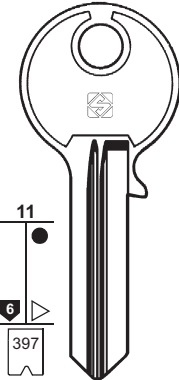

11
6
397



CB28R

4R
0-1-2-3-4-5-6-7-8

9R
0-1-2-3-4-5-6-7-8

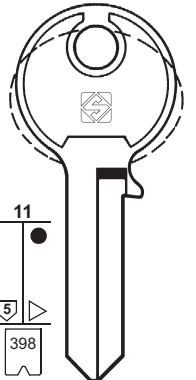

11
5
398



CB38

B4R
0-1-2-3-4-5-6-7-8-9

4T
0-1-2-3-4-5-6-7-8-9

SKILMANN

1234506
1234567890

PER:
FOR:

CORBIN (USA)

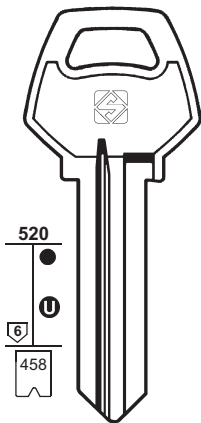

520
6
458

CB34R
1234567

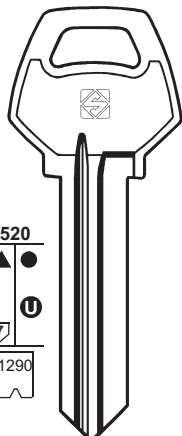

520
7
1290

CB25R
1234506
CB22R

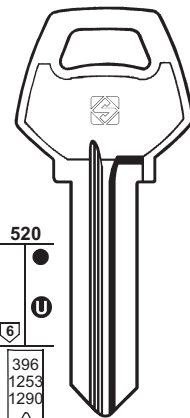

520
6
396
1253
1290

CB40R
1234506
1234567890
M 1234567890

CB26R
1234506
1234567890
M 1234567890

CB23R
1234506
1234567890
M 1234567890

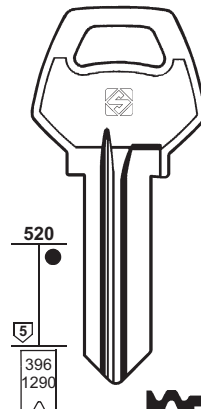

520
5
396
1290

CB33R
1234506
0123456789A
M 1234567890
..... 1234567

CB24R
1234506
1234567890
M 1234567890

CB41R
1234506
1234567890
M 1234567890

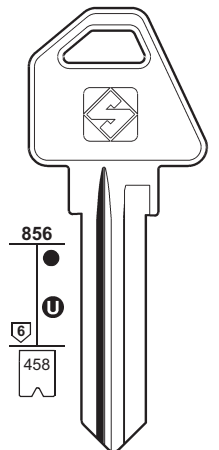

856
6
458

CB44R
1-2-3-4-5-6-7

CORBIN (AUS)
LANE

PER:
FOR:

CORBIN (USA)

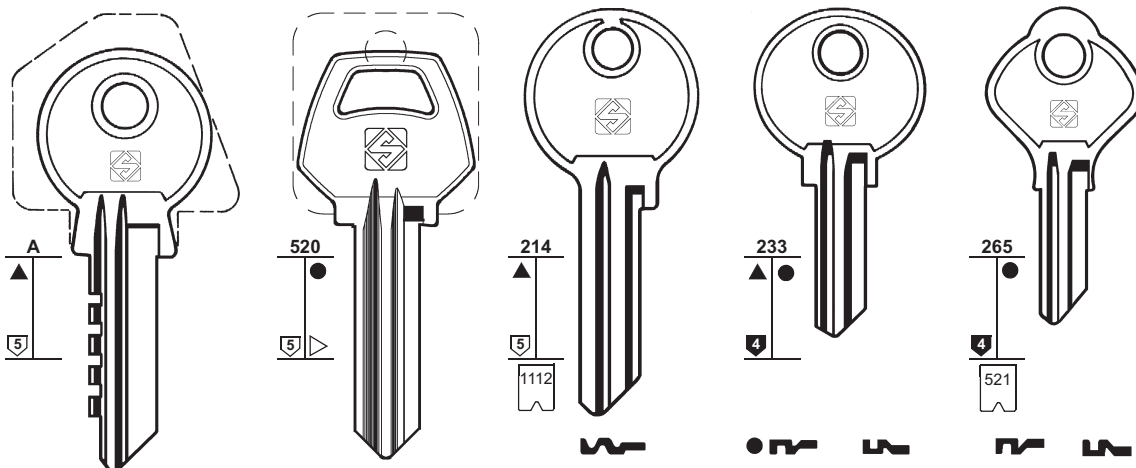

CB20

CB102R



CB10

2A 0-1-2-3-4-5-6-7-8-9
7A 0-1-2-3-4-5-6-7-8-9
8P 0-1-2-3-4-5-6-7-8-9



CB13



CB13R



CB14



CB14R

BGM ...
CAT ...
1-200



EMHART

CHANGE-O-MATIC

CCL



55

PER / FOR

CORBIN (USA)
CCL
CHANGE-O-MATIC
EMHART

CORNI (I)

333
BETA
CIC
EURONORM
FONTAINE
MUL.T.LOCK

CORONA (D)

BAB
BUG
DOCU
GEBRO
ZEISS IKON
+ BAB (26)
+ ZEISS IKON (201)

COTICO (D)

COUILLET (F)
 RICOUARD (146)

PER:
FOR:

CORNI

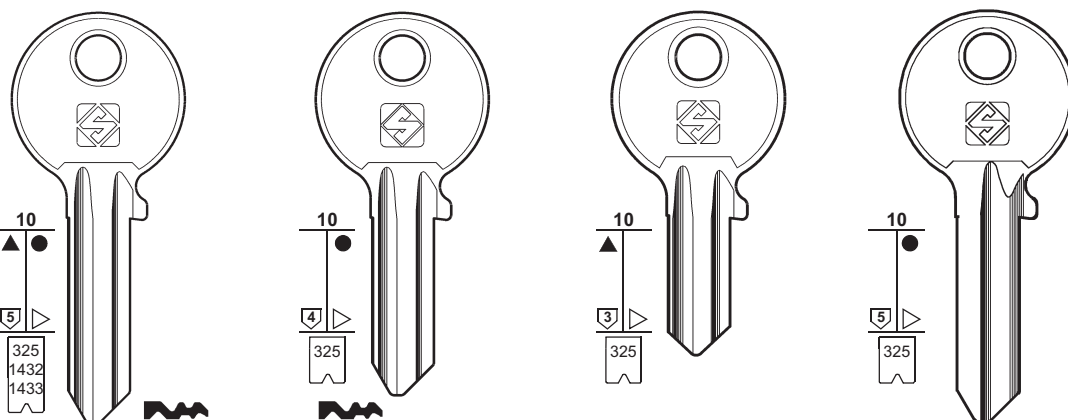

CC5
48 1-1000

CC4 0-1-2-3-4-5-6-7-8-9

CC3 0-1-2-3-4-5-6-7-8-9

CC6R
..... 0-1-2-3-4-5-6-7-8-9

CC2
48 1-1000

CC2R
48 1-1000
..... 28001-29000
..... 80000-80625
..... 85000-86000
..... 86000-87000

CC3 0-1-2-3-4-5-6-7-8-9

CC7 0-1-2-3-4-5-6-7-8-9

333 - BETA - CIC

BETA
EURONORM

BETA

FONTAINE
MUL.T.LOCK

PER:
FOR:

CORNI

CORONA

COTICO

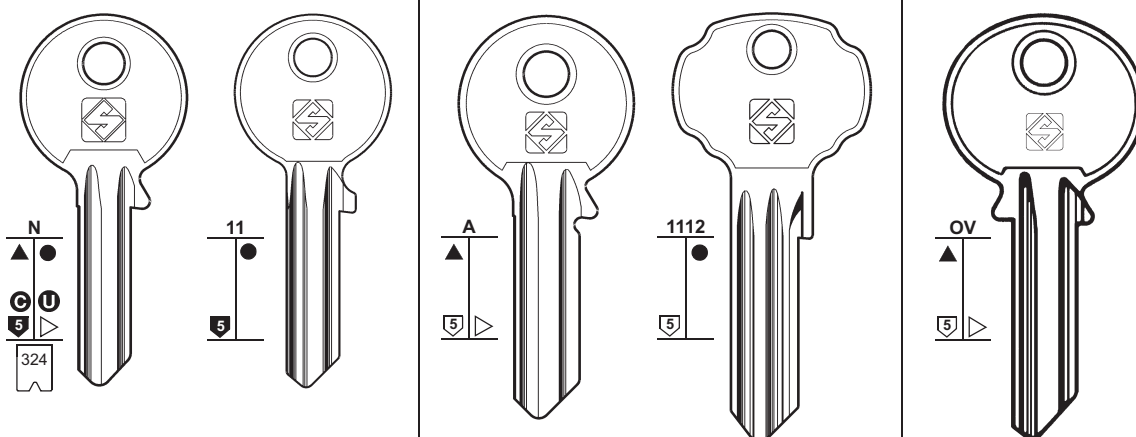

CC1
1-2-3-4-5

CC8

COR1

COR2 **COR2R**

CO1 **CO1R**

BAB - BUG - DOCU
GEBRO - ZEISS IKON



56

PER / FOR

C.R. (I)

CRC-CAMBÔA (P)
CORBIN (53)

CRISTANI (I)
R.C.

CROWN (RC)

CVL (E)

CWS (D)
DOM (61)

DAC (GR)

DAD (F)
DECAEUX
+ FORT (81)
+ L & F (116-117)
+ RONIS (146)
+ VACHETTE (181)

DAF (TR)

PER:
FOR:

C.R.

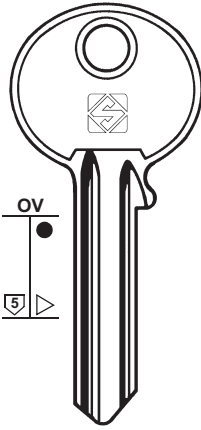

CRISTANI

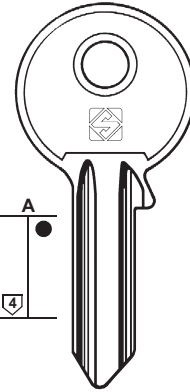
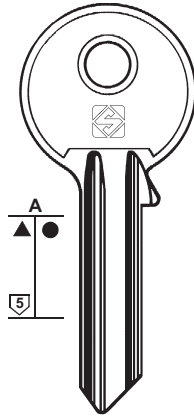

R.C.

CROWN

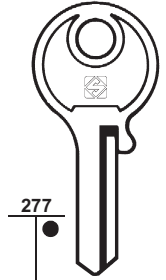

PER:
FOR:

CVL

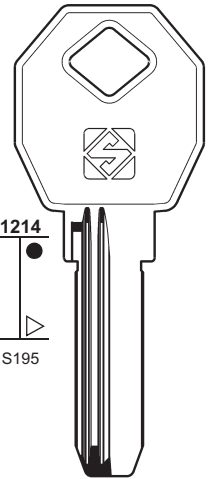
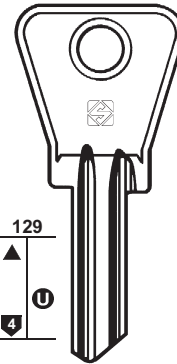
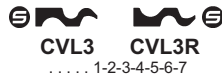
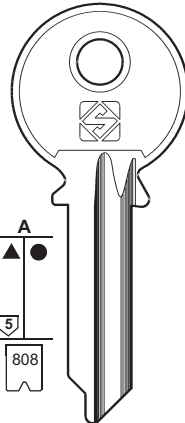
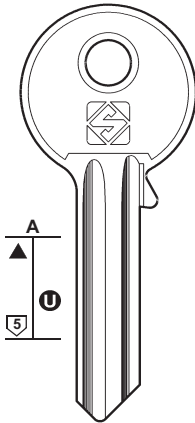

PER:
FOR:

DAC

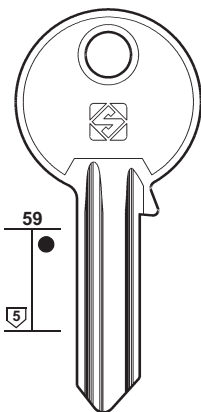

DAD

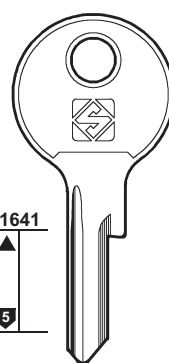
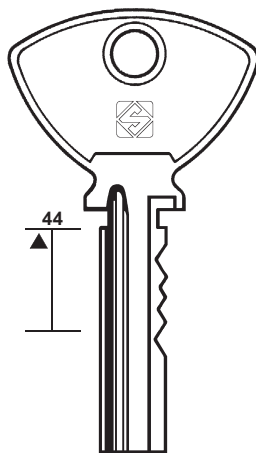





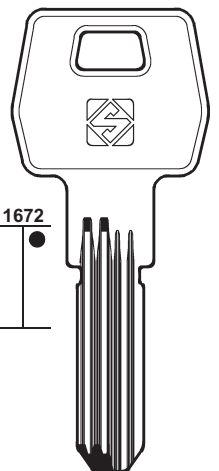
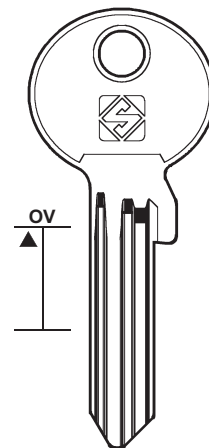

DECAEUX

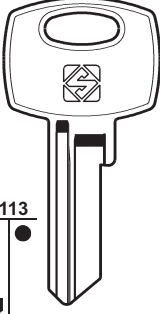
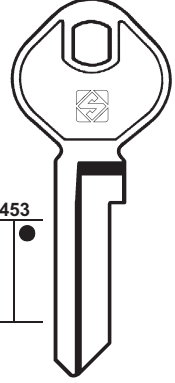
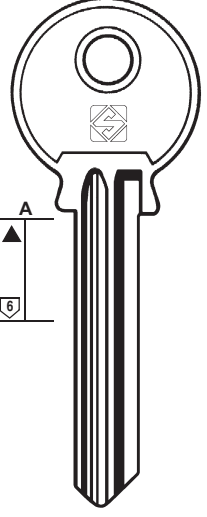
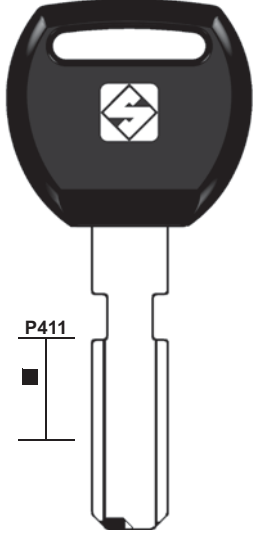

DAF











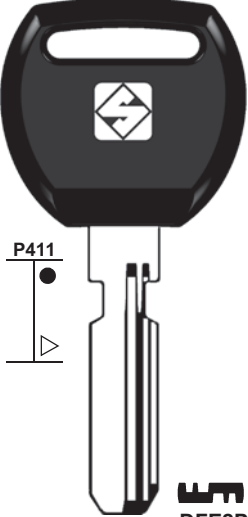
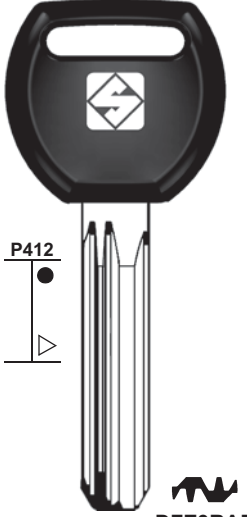
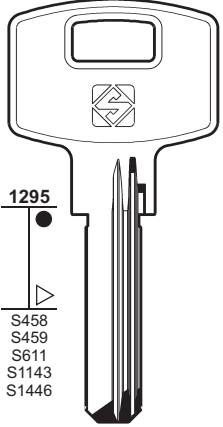
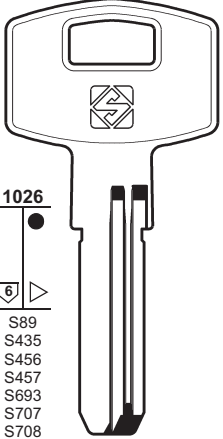







PER: DAIYA FOR:  1113  453  A  P411  DY1 4801-9600 K 1-960  DY1R 1-4800 S 1-960  DAL1  DAL2 DAL2R LIPS  DEA2  DFE1RP

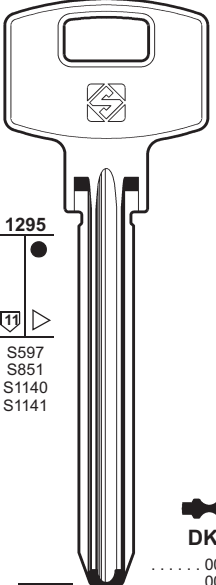
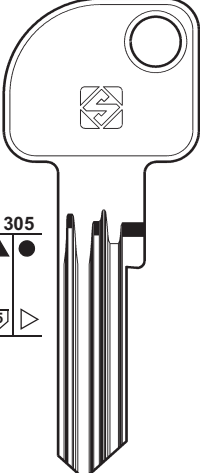
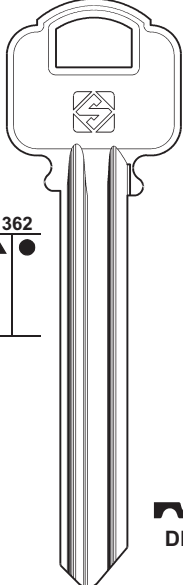
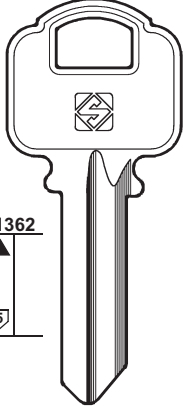

57

PER / FOR
DAIYA (RC)
DALWA (J) LIPS
DAMM (D) 👁️ BKS (30)
DAV (F) 👁️ RONIS (147)
DC (F) 👁️ RONIS (146)
DE ANGELI (I)
DEBEAURAIN (F) 👁️ RONIS (146)
DECAYEUX (F) 👁️ DAD (56) 👁️ DOM (62) 👁️ FORT (81) 👁️ O.NOVOX (136) 👁️ PICARDIE (141) 👁️ RICOUARD (146)
DEF (F) 👁️ KIFERM (106)
DEFEND LOCK (CZ)
DEHA (RC) 👁️ YETI (198-199)
DEKABA (BG) MAUER

PER: DEFEND LOCK FOR:  P411  P412  1295 S458 S459 S611 S1143 S1446  1026 S89 S435 S456 S457 S693 S707 S708 S1144 000016-280006  DFE2P  DFE3RAP  DK1 00001-85798 000001-028000  DK3 E2  DK6 E2  MAUER  MAUER

PER: DEKABA FOR:  1295 S597 S851 S1140 S1141  1305  1362  1362  DK7 000002-111985 000003-129307  DK5 F  DK4  DK8R  DK9R  MAUER  MAUER  MAUER
--



58

PER / FOR

DELCA (GR)
GEVY

DELTA (F)
RONIS (146)

DERLOCHE (F)
RONIS (146)

DESPREZ (F)
GABON (84)
RONIS (146)

DETHLEF (GB)
EURO-LOCKS (71)

DEXTER (I)

DIAMA (F)
FTH (82)

DIAMOND (RC)

PER:
FOR:

DELCA

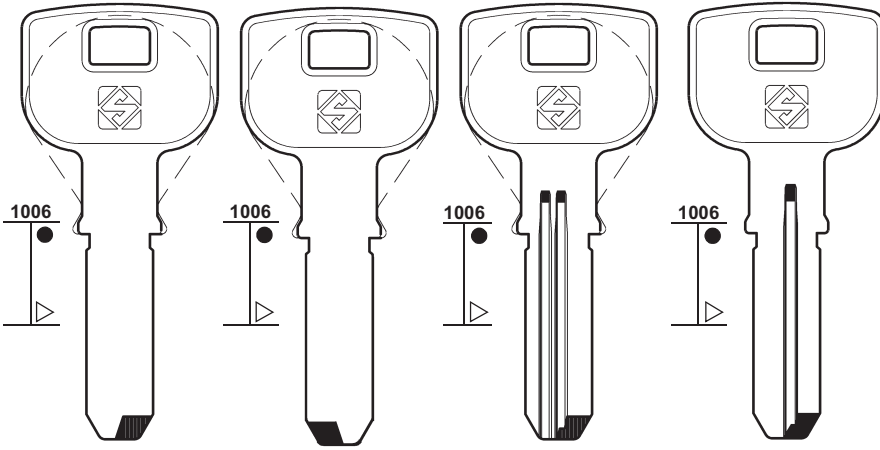

DLC1

DLC1R

DLC2R

DLC3



DEXTER

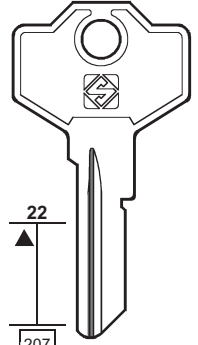

E....
9001-9741

GS4R



PER:
FOR:

DEXTER

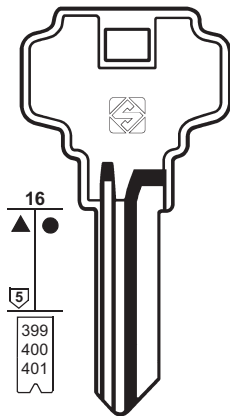

399
400
401

GM
DX18R

B2
DX6R

DX1

DX1R ▲ ●

BM
DX2R

..... 0-1-2-3-4-5-6-7
..... 0-1-2-3-4-5-6-7
..... 0-1-2-3-4-5-6-7-8-9
..... T 0-1-2-3-4-5-6-7-8-9

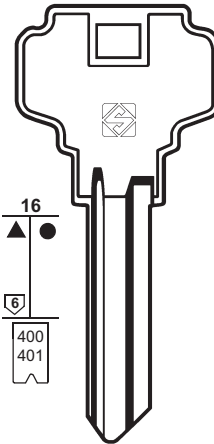

400
401

GM
DX17R ▲

CM
DX15R ▲

D3
DX13R ●

DX3 DX3R

B1
DX4R ▲

..... 0-1-2-3-4-5-6-7
..... 0-1-2-3-4-5-6-7-8-9
..... T 0-1-2-3-4-5-6-7-8-9

PER:
FOR:

DIAMOND

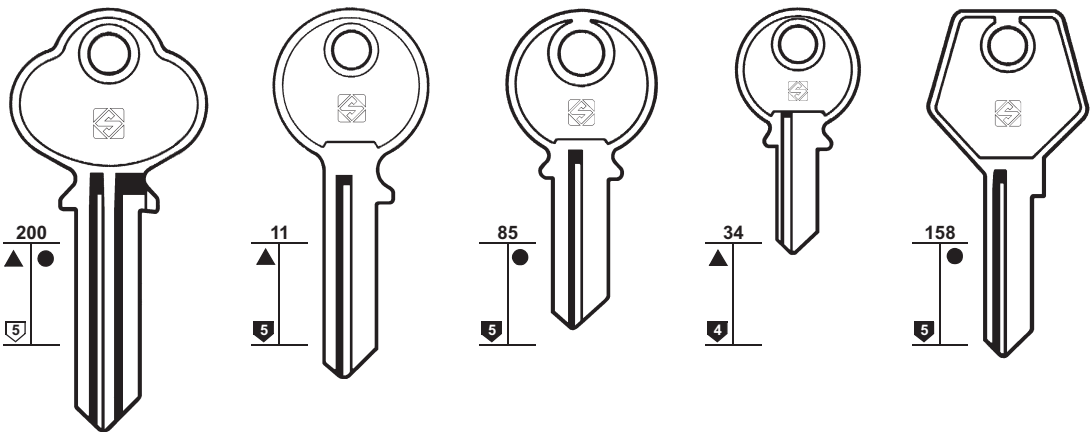

DN2

DN3

DN1

DN9R

DN4



PER:
FOR:

DIAMOND

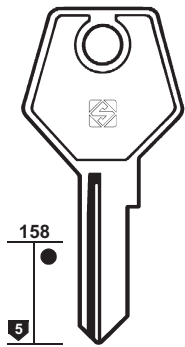

DN5

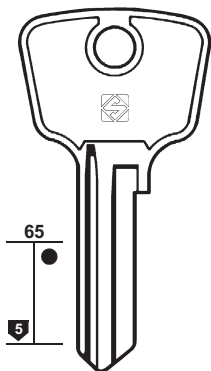

DN7

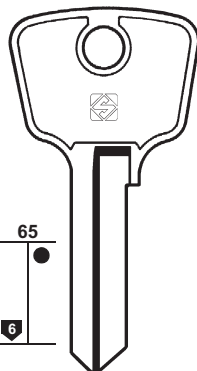

DN6

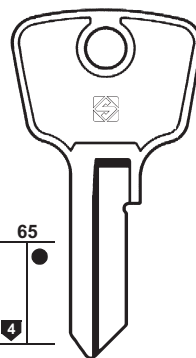

DN8



59

PER / FOR

DIAMOND (RC)

DIERRE (D)
+ WILKA (191)

DIFA (DK)
+ RUKO (148)

DIMITROVGRAD
(RUS)

DISQUIN (F)
+ TOK-WINKHAUS (169)

DLP
(D. LA PORTE) (D)
+ LA PORTE (110)

DNEPROPETROVSK
(UA)
FIMANEVSKI

DNS (GB)
+ EAGLE (67)

DOBLINA (D)

PER:
FOR:

DIERRE

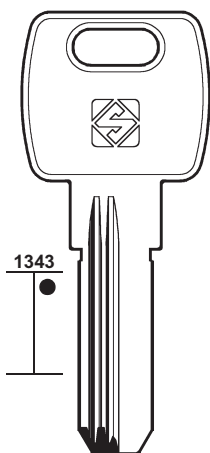

DIR1R



DIMITROVGRAD

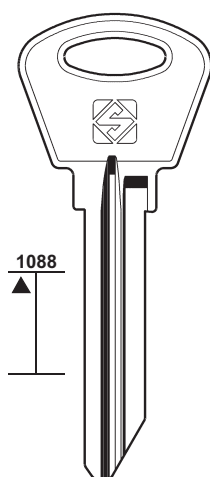

DMT1R

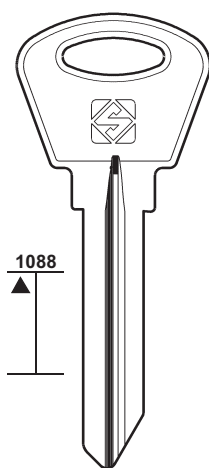

RUS3R



DMT2R

DLP (D. LA PORTE)

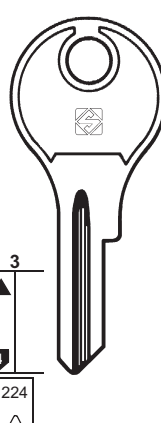

DL1R

... 2501-2550

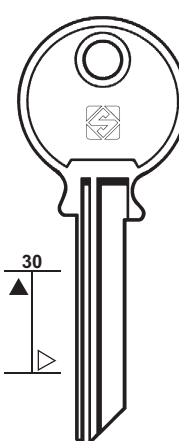

LAP3

PER:
FOR:

DLP (D. LA PORTE)

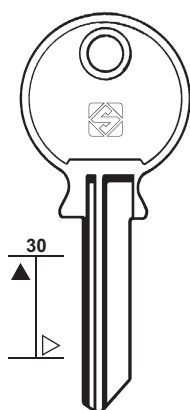

LAP2

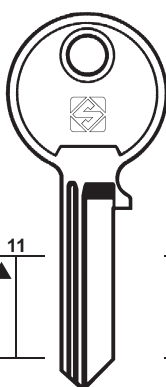

DL3

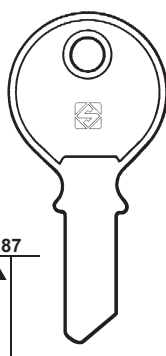

DL2

DNEPROPETROVSK

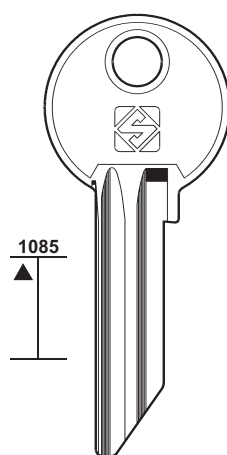

FMK1

FIMANEVSKI

DOBLINA

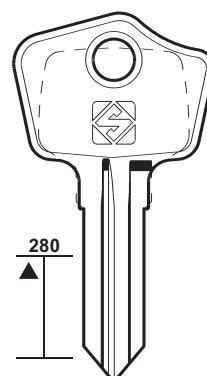

DB60



60

PER / FOR

DOBLINA (D)

DOBUS (D)

CISA (48)

DOCO (D)

CORONA (55)

DOFIN (F)

GLOBE (87)

DOM (D)

LISTA

NOBO

+ CORBIN (52)

+ EMR (69)

+ MLM (127)

+ STUV (163)

PER:
FOR:

DOBLINA

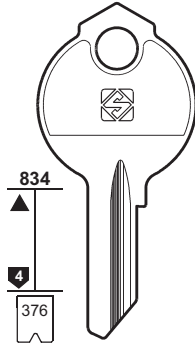

... 201-626

DB1 35 ...	DB1R 34 ...	DB12 22 ...	DB12R 23 ...	DB28 120 ...	DB28R 121 ...	DB44 H ...	DB44R G ...
DB2 U ...	DB2R V ...	DB13 25 ...	DB13R 24 ...	DB29 122 ...	DB29R 123 ...	DB45 L ...	DB45R K ...
DB3 2 ...	DB3R 1 ...	DB14 27 ...	DB14R 26 ...	DB30 125 ...	DB30R 124 ...	DB46 M ...	DB46R N ...
DB4 3 ...	DB4R 4 ...	DB15 29 ...	DB15R 28 ...	DB31 130 ...	DB31R 131 ...	DB47 P ...	DB47R R ...
DB5 6 ...	DB5R 5 ...	DB16 31 ...	DB16R 30 ...	DB32 132 ...	DB32R 133 ...	DB48 S ...	DB48R T ...
DB6 8 ...	DB6R 7 ...	DB17 32 ...	DB17R 33 ...	DB33 134 ...	DB33R 135 ...	DB49 Y ...	DB49R Z ...
DB7 11 ...	DB7R 12 ...	DB18 36 ...	DB18R 37 ...	DB34 136 ...	DB34R 137 ...	DB50 1Z ...	DB50R 1Y ...
DB8 14 ...	DB8R 13 ...	DB19 39 ...	DB19R 38 ...	DB35 138 ...	DB35R 139 ...	DB51 1A ...	DB51R 1B ...
DB9 15 ...	DB9R 16 ...	DB20 40 ...	DB20R 41 ...	DB36 141 ...	DB36R 140 ...	DB53 1E ...	DB53R 1F ...
DB10 17 ...	DB10R 18 ...	DB21 42 ...	DB21R 43 ...	DB37 142 ...	DB37R 143 ...	DB54 1H ...	DB54R 1G ...
DB11 20 ...	DB11R 21 ...	DB22 44 ...	DB22R 45 ...	DB38 145 ...	DB38R 144 ...	DB55 1K ...	DB55R 1L ...
		DB23 47 ...	DB23R 46 ...	DB39 147 ...	DB39R 146 ...	DB56 1M ...	DB56R 1N ...
		DB24 48 ...	DB24R 49 ...	DB40 148 ...	DB40R 149 ...	DB57 1R ...	DB57R 1P ...
		DB25 51 ...	DB25R 50 ...	DB41 B ...	DB41R A ...	DB58 1T ...	DB58R 1S ...
		DB26 53 ...	DB26R 52 ...	DB42 D ...	DB42R C ...	DB59 1X ...	DB59R 1W ...
		DB27 54 ...	DB27R 55 ...	DB43 F ...	DB43R E ...		

PER:
FOR:

DOM

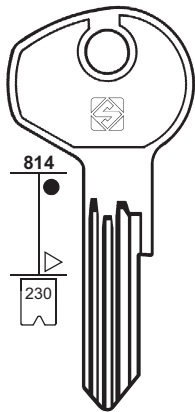

ZDDM ... 101-150
7F ... (KN)
1F ... 501-513
YSNR ... 201-275
YVLF ... (KN) 201-275
YZFZ ... (KN) 201-275

DM106

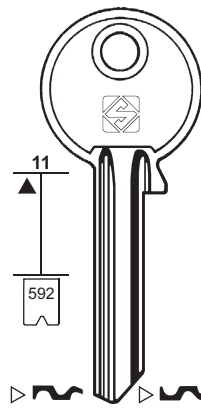

DM13 4 DM13R 3

DM96 1E ... 1-160

DM104R KNK

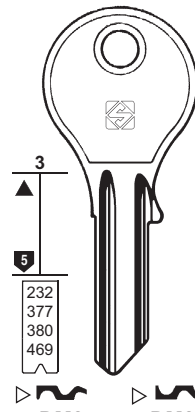

DM2 3 DM2R 4
EV ... 1-2840
GS ... 1-1000
FT ... 1-1000
CQ ... 301-400
... 1-1000

DM62 DM62R



NOBO

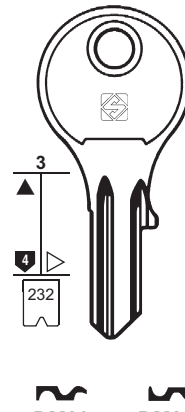

DM23 29 DM23R 3
CL ... 501-750
ED ... 1-380
EG ... 1-250



LISTA

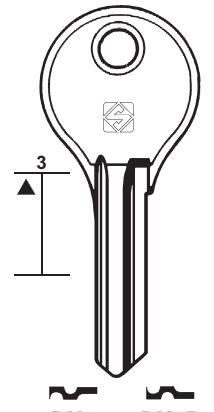

DM5 DM5R



PER:
FOR:

DOM

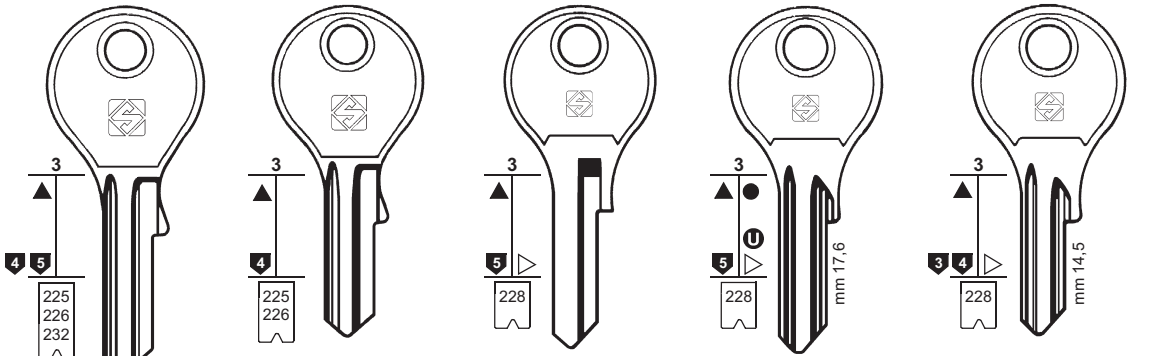

DM4 80138-80748
..... 80761-83242
DN ... 1-120

DM4R

DM6 80138-80748
..... 80761-83242

DM39 6E ... 1-205
..... 7E ... 269-473

DM39R

DM8 2D ... 1-222
5A ... 1-2600
9A ... 1-5200
W ... 1-50
1D ... 601-654
2W ... 1-50

DM8R

DM10 2A ... 1-34
DB ... 1-148
CF ... 1-140
3A ... 1-82
4A ... 1-482
1D ... 501-560
1D ... 1-57
FG ... 1-615
FS ... 1-60

DM10R 1D ... 58-114
2A ... 35-68

DM61 GS ... 1-1000
..... 1-1000

DM61R

DM6R 80138-80748
GP ... 1-250
C ... 1001-1200
CL ... 1-250
C ... 1301-1500

BARRO - IDEAL - TM

CHRIST

EAO - SWISSTAC

BTV - DECAEUX
HÄFELE - HEKNA
HUWIL - METEOR
MLM - RUKA
SCHLEGEL - STS

CWS - HÄFELE
HEKNA - HUWIL
MENOVA - METEOR
MLM - RUKA
SINJET



61

PER / FOR

DOM (D)
BARRO
BTV
CHRIST
CWS
DECAEUX
EAO
FLAMBO
GEWIRU
HÄFELE
HEKNA
HUWIL
IDEAL
MENOVA
METEOR
MLM
NOBO
PEROHAUS
RAFI
RUKA
SCHLEGEL
SINJET
STS
SWISSTAC
TM

+ CORBIN (52)
+ EMR (69)
+ MLM (127)
+ STUV (163)

PER:
FOR:

DOM

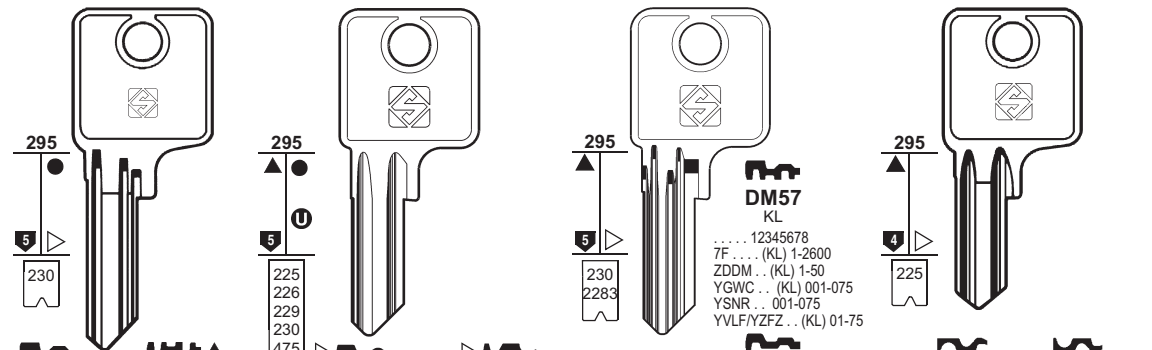

DM41 12345678
7F ... (KL) 1-2600
ZDDM ... (KL) 1-50
YGWC ... (KL) 001-075
YSNR ... 001-075
YVLF/YZFYZ ... (KL) 01-75

DM41R

DM16 DC ... 1-1800
K ... 1-50
GD ... 1-1800
GZ ... 1-1800
3E ... 1-350
2C ... 1-2600

DM16R

DM102 VN WS
DM111 YSNR ... (WS) 2701-2775
YZFYZ ... (WS) 2701-2775

DM102R

DM37 WL
DM113 YSNR ... (WL) 2701-2775
YZFYZ ... (WL) 2701-2775

DM37R
DM137

DM36 C ... 1001-1200
CL ... 1-250
GP ... 1-250
C ... 1301-1500

DM36R

DM19 DN ... 1-120
..... 80138-80748
..... 80761-83242

DM19R YSNR ... (WL) 2701-2775
YZFYZ ... (WL) 2701-2775

FLAMBO - HEKNA
NOBO - PEROHAUS

GEWIRU

PER:
FOR:

DOM

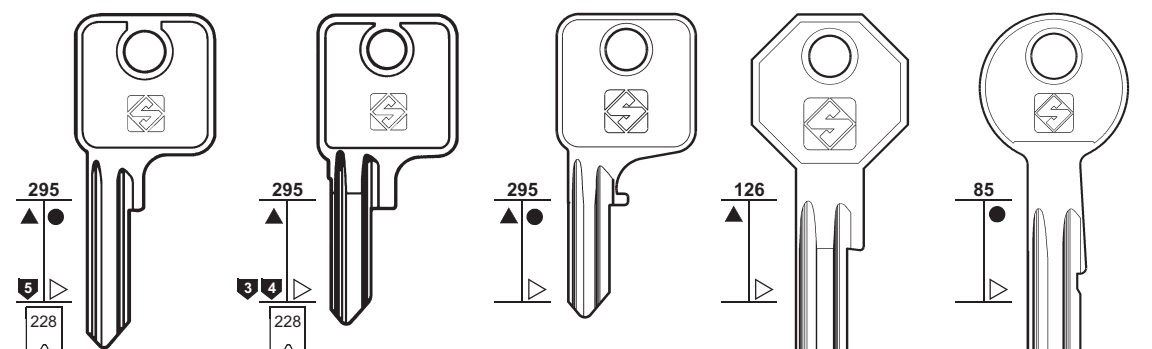

DM63 2D ... 1-222
5A ... 1-2600
9A ... 1-5200
W ... 1-50

DM63R

DM34 CF ... 1-140
DB ... 1-148
2A ... 1-34
4A ... 1-482
1D ... 1-57
FG ... 1-615
3A ... 1-82
1D ... 501-560

DM34R 1D ... 58-114
2A ... 35-68

DM110

DM116

DM114

BMW

RAFI



62

PER / FOR

DOM (D)
 CORBIN
 DYES
 EMHART
 FORTSCHRITT
 HÄFELE
 HÖHRMANN
 LISTA
 MAQUET
 MARCO
 MIPPART
 MLM
 STEIGA
 STS
 STUV
 VARIO
 VIKI
 VOKO

- + CORBIN (52)
- + EMR (69)
- + MLM (127)
- + STUV (163)

PER:
FOR:

DOM

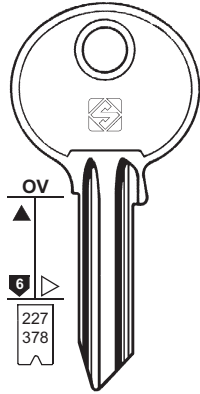

DM7 **DM35R**
 FA ... 1-3948
 CD ... 1-500

VARIO

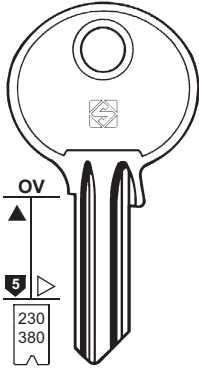

DM25
 EV ... 1-2840
 4C ... 1-3000

HÖHRMANN

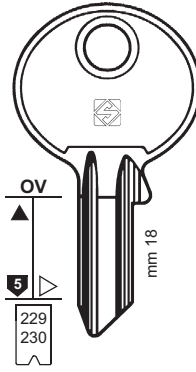

DM48
 2C ... 1-2600
 DC ... 1-1800
 3E ... 1-350
 GD ... 1-1800
 GZ ... 1-1800
 1C ... 1-363
 TB ... 1-1796

DYES - FORTSCHRITT - HÄFELE
 LISTA - MAQUET - MARCO
 MIPPART - MLM - VOKO

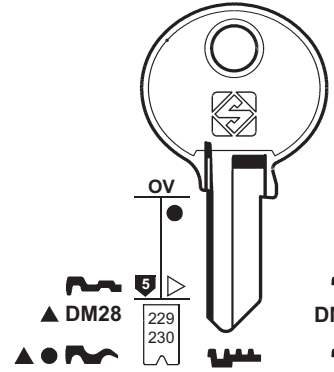

DM11 **DM123-6**
 2C ... 1-2600
 DC ... 1-1800
 3E ... 1-350
 GD ... 1-1800
 GZ ... 1-1800
 1C ... 1-363
 TB ... 1-1796
 YSNR ... (VN) 1201-1275
 YSNR ... (WN) 2201-2275
 YZfZ ... (VN) 1201-1275

DM123-1 **DM123-7**

DM123-2 **DM123-8**

DM123-3 **DM123-9**

DM123-4 **DM123-10**

PER:
FOR:

DOM

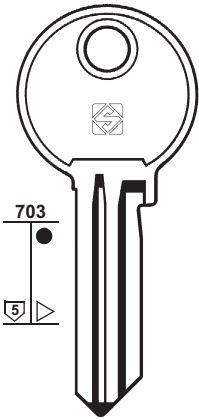

DM98R
 E

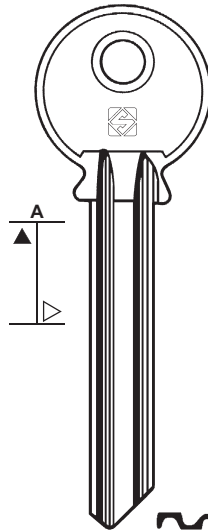

DM32

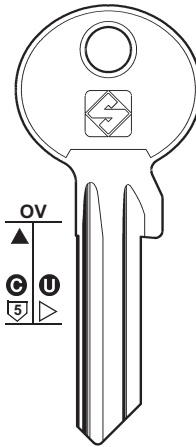

DM3X

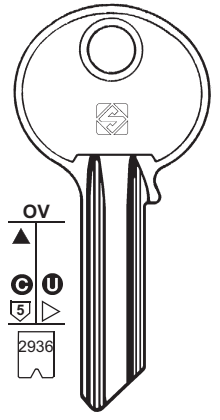

DM3 **DM105R**
 01234567
 STEIGA
 STUV - VIKI

PER:
FOR:

DOM

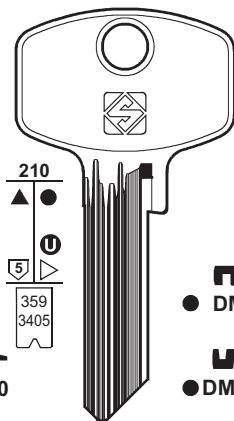

DM150

DM20
 PT 129893-130092

DM14

 0-1-2-3-4-5-6-7-8-9
 PT
 129893-130092

DM103

DM141R

DM97R

DM119
 CORBIN
 0123456789
 0123456789

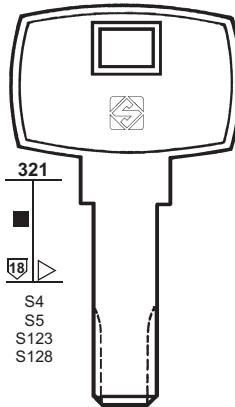

DM22



CORBIN - EMHART

DM22TVP

DM22TV5

DM22TV10

DM22TV4

DM22TV9

DM22TV3

DM22TV8

DM22TV2

DM22TV7

DM22TV1

DM22TV6

PER:
FOR:

DOM

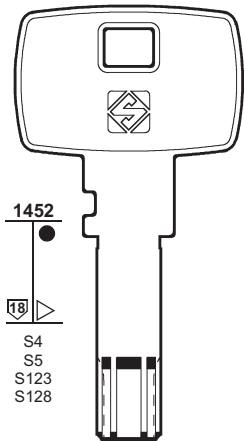

DM22TVPX **DM22TV5X**

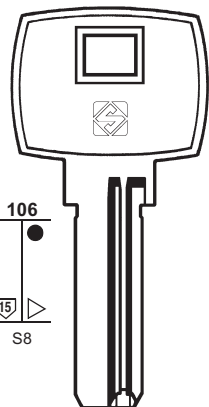

DM24 **DM64**
IX5



DM118

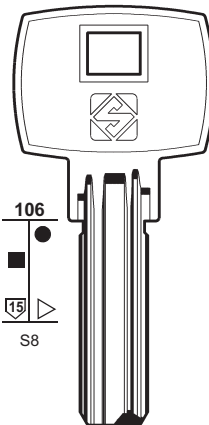

DM120 **DM122**



63

PER / FOR

DOM (D)

ASPA
CORBIN
EMHART
IR
LAPERCHE
MOREAUX
NOBO
STS

- + CORBIN (52)
- + EMR (69)
- + MLM (127)
- + STUV (163)

PER:
FOR:

DOM

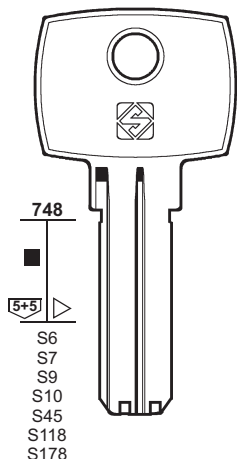

DM49 **DM53**

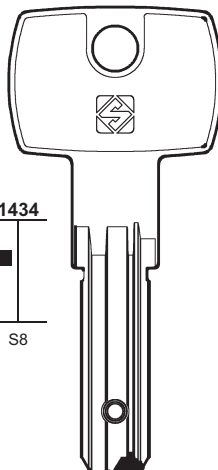

DM139 **DM145**
IX5

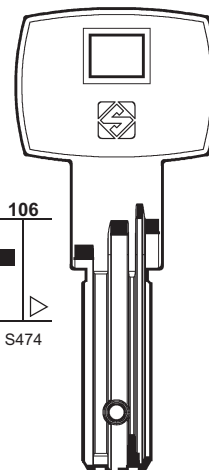

DM144
IX6



PER:
FOR:

DOM

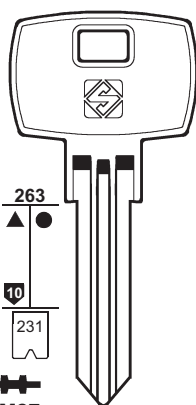

DM27
1H ... 1-4088
3H ... 1-600

DM17 **DM17R**

1H ... 1-4088
2H ... 1-2088
3H ... 1-600

ASPA

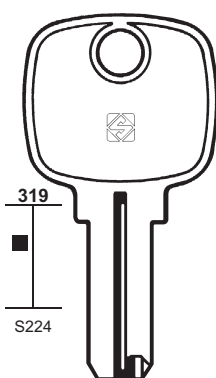

S224

DM21

..... 0-1-2-3-4-5

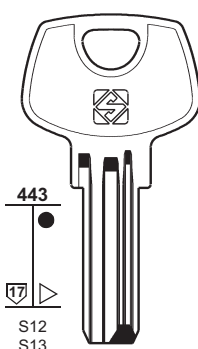

S12
S13

DM138

DM55
2Y

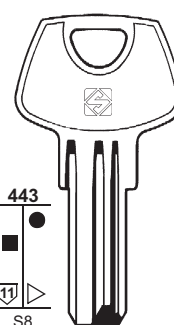

S8
S11

DM128

DM58





64

PER / FOR

DOM (D)

PER:
FOR:

DOM

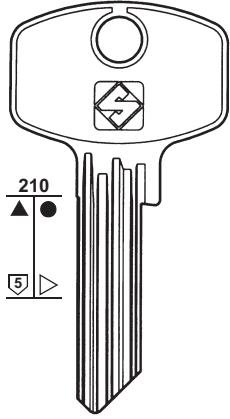

DM40
L



DM44
M



DM18R
C



DM42
D



DM29
P



DM43
U



DM40R
L



DM44R
M



DM18
C



DM42R
D



DM29R
P



DM43R
U



DM67



DM50



DM67R



DM66



DM68



DM69



DM70



DM74



DM60



DM66R



DM68R



DM69R



DM70R



DM74R



DM47
Q



DM46
R



DM26
S



DM47R
Q



DM46R
R



DM26R
S



DM71



DM72



DM73



DM75



DM115



DM71R



DM72R



DM73R



DM75R



DM115R



DM45
T



DM45R
T



DM33R



DM12-1



DM12-10



DM12-19



DM12-28



DM12R-12



DM12-37



DM12-46



DM12-2



DM12-11



DM12-20



DM12-29



DM12R-13



DM12-38



DM12-47



DM12-00



DM12-3



DM12-12



DM12-21



DM12-30



DM12R-16



DM12-39



DM12-4



DM12-13



DM12-22



DM12-31



DM12R-19



DM12-40



DM12-5



DM12-14



DM12-23



DM12-32



DM12R-31



DM12-41



DM12R-00



DM12-6



DM12-15



DM12-24



DM12-33



DM12R-32



DM12-42



DM12-7



DM12-16



DM12-25



DM12-34



DM12R-34



DM12-43



DM12-8



DM12-17



DM12-26



DM12-35



DM12R-35



DM12-44



DM12-9



DM12-18



DM12-27



DM12-36



DM12R-36



DM12-45

PER:
FOR:

DOM



65

PER / FOR

DOM (D)

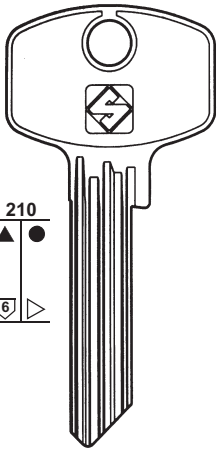



66

PER / FOR

DOMINION (USA)
PETERBORO
+ ARROW (18)

DOMUS (I)
+ CAS-CISMA (40)

DOMUS (GR)

PER:
FOR:

DOMINION

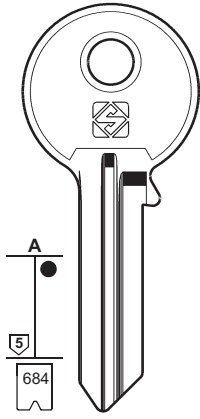

DO1R

1-2-3-4-5-6-7-8-9
PETERBORO

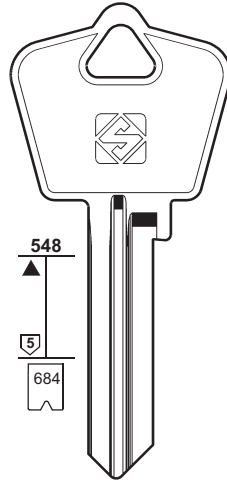

DO2R

1-2-3-4-5-6-7-8-9

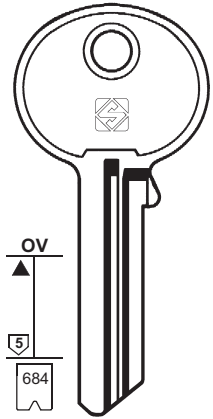

DO6

1-2-3-4-5-6-7-8-9

PER:
FOR:

DOMINION

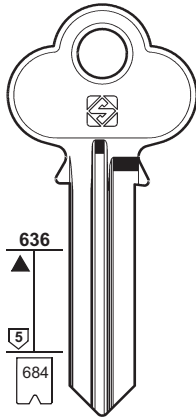

DO10

1-2-3-4-5-6-7-8-9

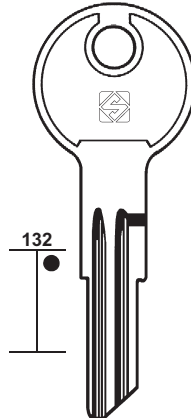

DO11

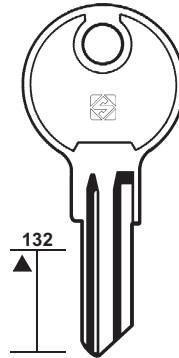

DO12

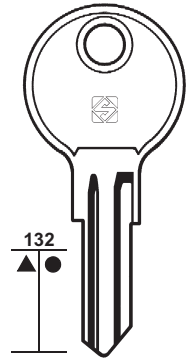

DO13



PER:
FOR:

DOMUS (I)

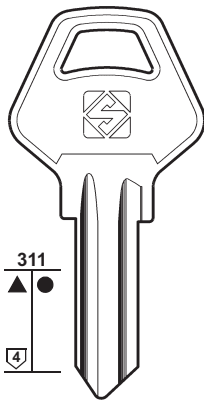

DS4

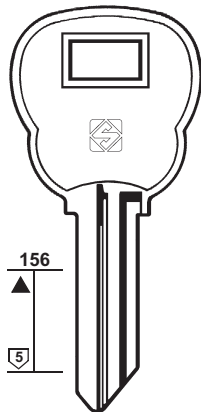

DS1



DS1R

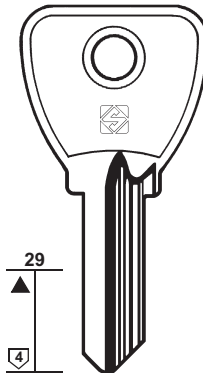

DS2

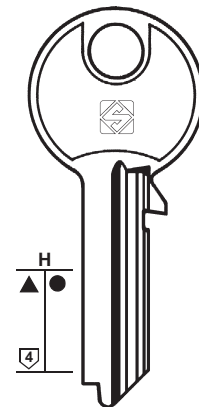

DS3R



DS5R

DOMUS (GR)

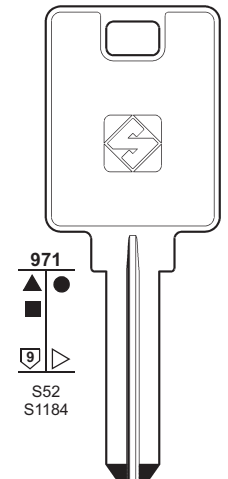







DS6

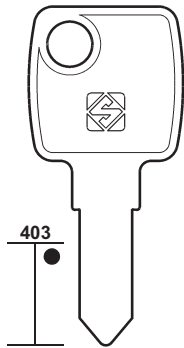
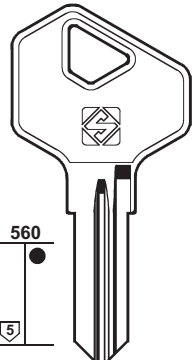
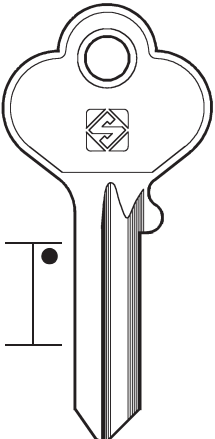
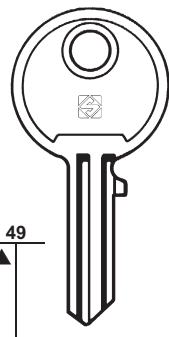







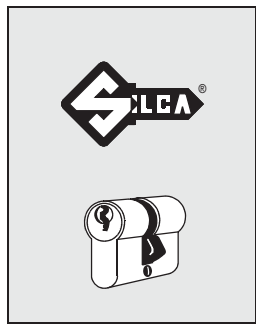

DS7

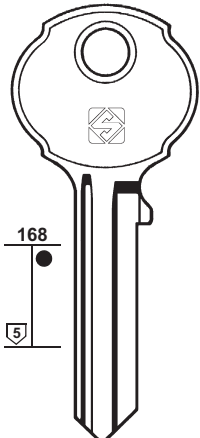
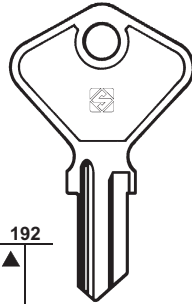
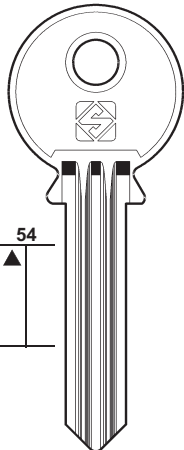
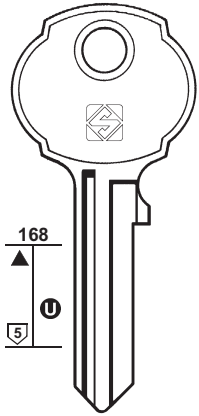

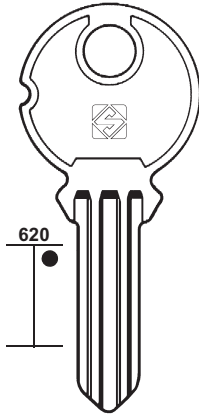





PER: FOR:	DONG HWA	DORIC	DORSET	DOUBLE ARROWS
	 403	 560 5	 ●	 49
	 DOW1R	 DRC1	 DRS1R	 DW1 

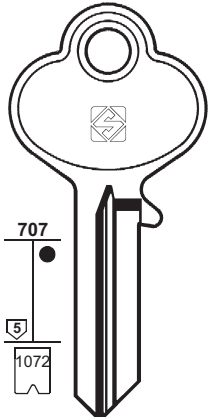
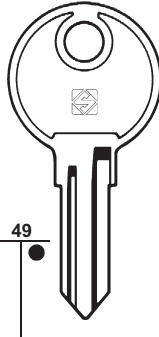
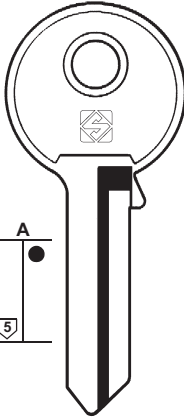
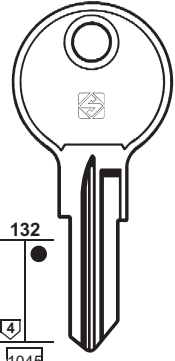

67

PER: FOR:	DOUBLE CIRCLE	DUPLOMATIC	EAG
	 168 5	 192	 54
	 168 5	 DP1 ● DP1R	 620
	 DCR1		 EA1
	 DCR2		 EA2
			 EA3
			 EA4
	TRI-CIRCLE		

PER / FOR
DONG HWA (RC)
DORIC (AUS)
DORMA (D) WILKA (191)
DORSET (IND) KABA (103)
DOUBLE ARROWS (RC)
DOUBLE CIRCLE (RC) TRI-CIRCLE
DOUBLE SAFE (GB) EURO LOCKS (71) L & F (116)
DUBOIS (F) LAS (110)
DUO (USA) ILLINOIS (96)
DUPLOMATIC (I)
DYES (D) DOM (62)
EAG (D)
EAGLE (USA) DNS HARLOCK LORI
EAO (D) DOM (61)
EAST (RC)
EBA (I) MERONI (124)
ECM (P)

PER: FOR:	EAGLE	EAST	ECM
	 707 5 1072	 49	 A 5
	 132 4 1045		
	 EG1	 EAS1	 ECM1
	 EG2		 ▲ ECM1R
	 EG2R		
 1-2-3-4-5-6-7-8-9-0		
	DNS - HARLOCK - LORI		



68

PER / FOR

EFCO (AUS)

EFSA (F)

👁️ BABY-CLIP (27)

EGSA

👁️ TOK-WINKHAUS (170-171)

EIKO (RC)

👁️ CINA (48)

EKLA (HK)

👁️ GUARD (90)

ELCA (D)

STS
TESA
VIRO

ELDON (D)

👁️ EMKA (69)

ELEPHANT (RC)

👁️ TRI-CIRCLE (172)

ELFIN (I)

👁️ CEMA (41)

ELKO (CZ)

ELMO (USA)

👁️ BASCO (28)

ELP (RUS)

ELSA (I)

👁️ GIUSSANI (86)

ELSET (F)

👁️ CLAUSOR (51)

ELSI (I)

👁️ INDESIT (96)

ELVOX (I)

👁️ GIUSSANI (86)

ELZETT (H)

TIEFENTHAL
+ 👁️ CES (41-42)

EMGE (F)

👁️ RONIS (147)

EMHART (USA)

👁️ CORBIN (55)

👁️ DOM (62-63)

👁️ RONIS (146-147)

PER:
FOR:

EFCO

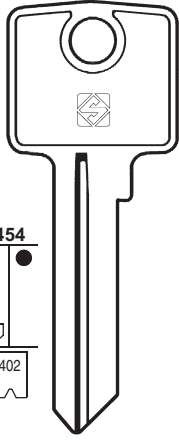

454
6
402

0-1-2-3-4-5-6-7-8-9



- CA EF1R
- CK EF2R
- DA EF3R
- DB EF4R
- DK EF5R
- DM EF6R

ELCA

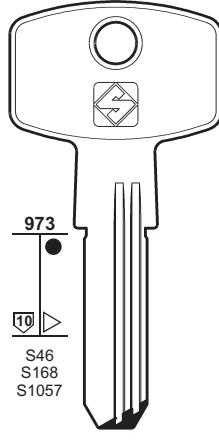

973
10
S46
S168
S1057



STS - TESA - VIRO

ELKO

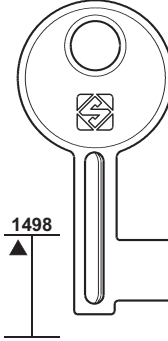

1498



ELP

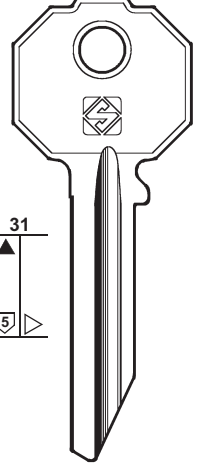

31
5



PER:
FOR:

ELZETT

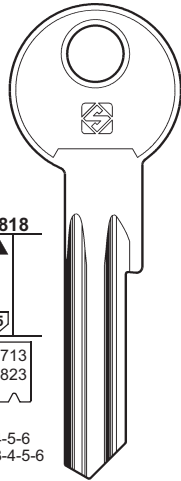

818
5
713
823
1-2-3-4-5-6
0-1-2-3-4-5-6

EL1X

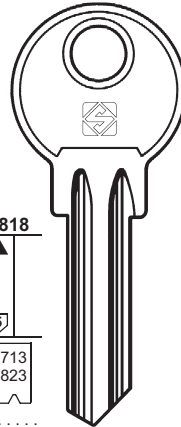

818
5
713
823
1-2-3-4-5-6
0-1-2-3-4-5-6

EL1

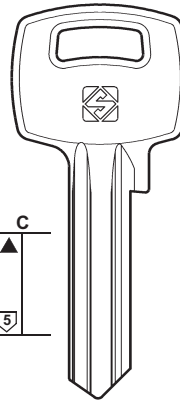

C
5

EL1C

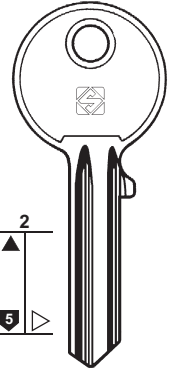

2
5

EL3

PER:
FOR:

ELZETT

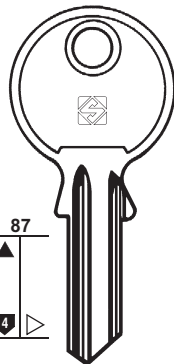

87
4

EL2

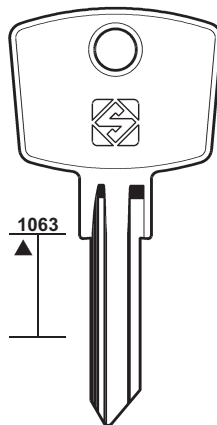

1063

EL4
EL6

EL5R
EL7R

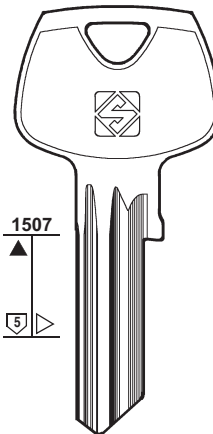

1507
5



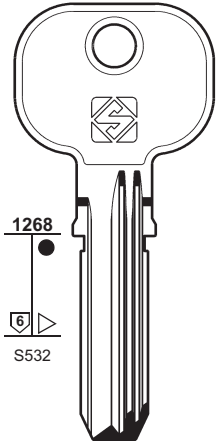





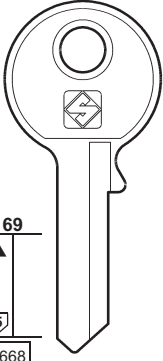
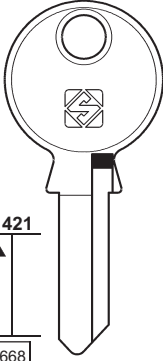

EL10

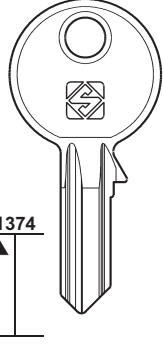
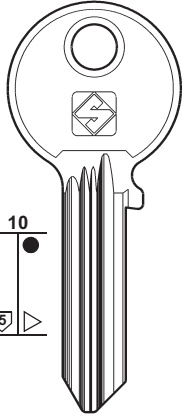

1268
6
S532
0-1-2-3-4





EL9

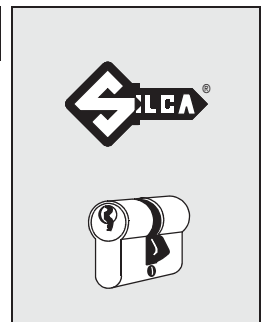



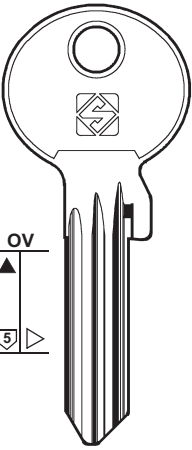
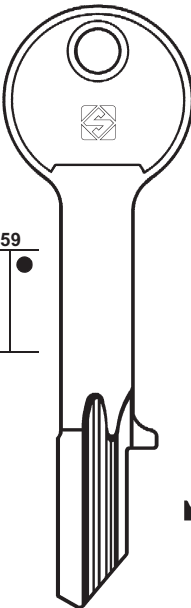
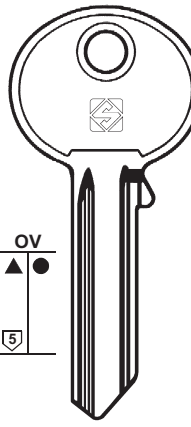
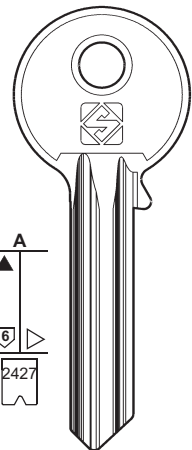

EMKA				EMR
				
69 ▲ 5 668	1421 ▲ 5 668	1421 ▲ 5	1374 ▲ 5	10 ● 5
..... 1-2-3-4	XX ... 091-320			
				
EMK1	EMK5	EMK6R	EMK2	EM4
				
				EM1R
				EM2R
				EM3R
				EM3
ELDON - GHE KOVER - RONIS				DOM - GTV - JOWIL TIEFENTHAL

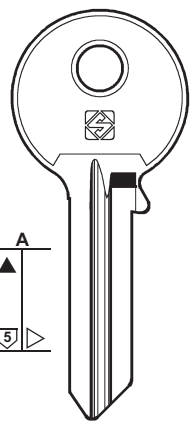
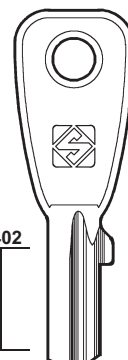
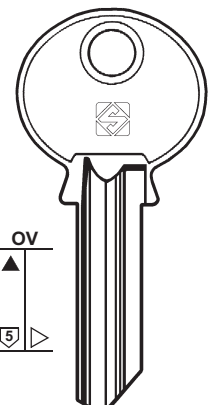
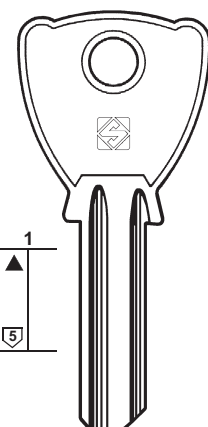

69

EMR	ENEL	ERA	
			
OV ▲ 5	59 ●	OV ▲ 5	A ▲ 6 2427
		 1-2-3-4-5-6-7-8-9
			
EM11	EN1R	ER1	ER2
GTV - JOWIL			

ERA		ERTEL	ESA
			
A ▲ 5	1402 ▲	OV ▲ 5	1 ▲ 5
			
ER3R	ER4R	ERT1	ES1R
			ES1
			NUMIDIA

PER / FOR

EMKA (F)
 ELDON
 GHE
 KOVER
 RONIS
 + EURO LOCKS (70)
 + FORT (81)
 + RONIS (146)
 + TITAN (167)
 + WILKA (191)

EMR (D)
 DOM
 GTV
 JOWIL
 TIEFENTHAL

ENAX (F)
 TOK-WINKHAUS (171)

ENEL (I)

EPO (J)
 SCHLAGE (151)

EQUIBATIR (F)
 RONIS (146)

ERA (GB)

ERICSSON (S)
 TEKA (165)

ERMEX (S)
 TEKA (165)

ERTEL (D)

ESA (E)
 NUMIDIA

ESAFE (E)
 EZCURRA (73)
 TESA (165)

ESCO (D)
 CISA (48)
 CORBIN (53)

ESLA (GB)
 CISA (49)

ESS (D)
 BAB (25)

ESSENDIA (S)
 CISA (48)

ESZ (D)
 JOWIL (100)

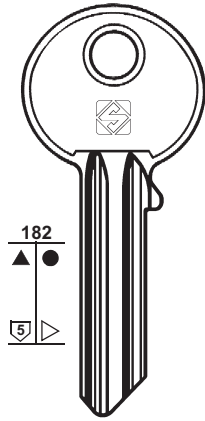
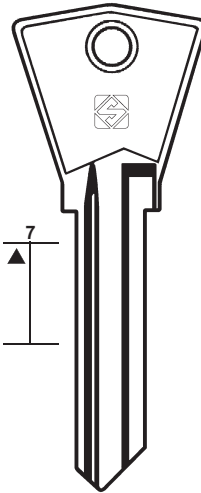

70

PER / FOR**ETAS (GB)**
YANEDIS**ETF (F)**
+ BABY CLIP (27)**ETNA (I)**
+ CAS-CISMA (40)**EUREKA (I)**
ITALBLOCK**EURO LOCKS (B)**
FASMA
L & F
SCHULTZ
+ BASTA (28)
+ CHICAGO (46)
+ L & F (116-117)**PER: ETAS**182
▲ ●
5 ▷**ETA1****YANEDIS****PER: ETF**

7

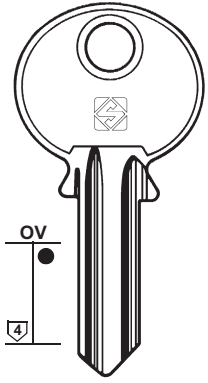
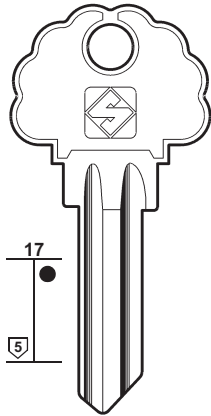
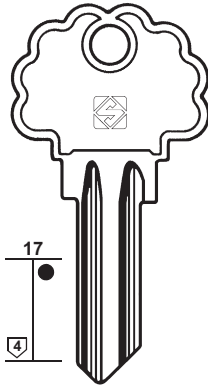
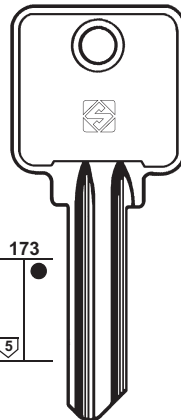
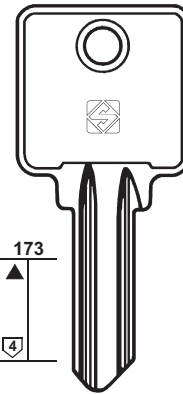
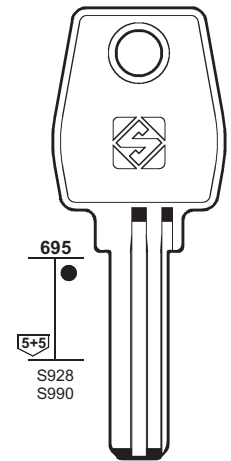
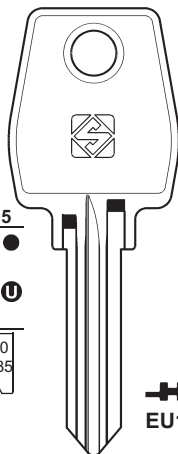
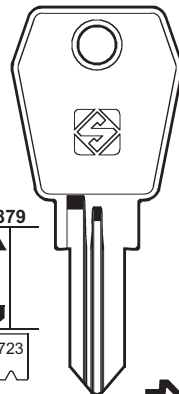
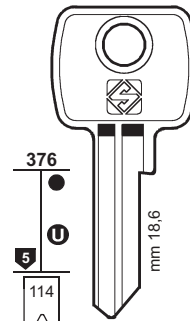
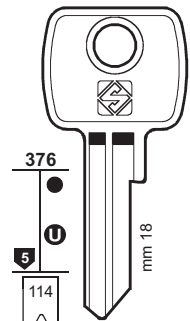
**ETF1****PER: ETNA**OV
4**ET1****ET1R****▲ ET2R****PER: EUREKA**17
●
5**EK1**17
●
4**EK1R****▲ EK2R**173
●
5**EK4**173
▲
4**EK3****● EK3R****ITALBLOCK****PER: EURO LOCKS**695
●
5+5
S928
S990**EU17****PER: EURO LOCKS**695
▲ ●
10 U
200
1435**EU3****EU11R**... 2151-2949
K ... 5272-6291**SCHULTZ**879
▲ ●
7
723**EU19****EU18R****▲ ● EU5R**
... 25001-27000
FASMA376
●
5 U
114
mm 18,6**LF4****LF4R**60 ... 1-400
90 ... 1-200
92 ... 1-400
... 1-400
GHM ... 1-155
M ... 1-400
92 ... 401-600
99 ... 1-400
RV ... 1-400
RVM ... 1-400
SP ... 1-400
GS ... 1-400
... ES1
... EV1376
●
5 U
114
mm 18**LF6****LF6R**90 ... 1-200
... 1-400
91 ... 201-275
GH ... 1-400
SS ... 1-400
91 ... 276-350**LF18R****L & F**

PER:
FOR:

EURO LOCKS

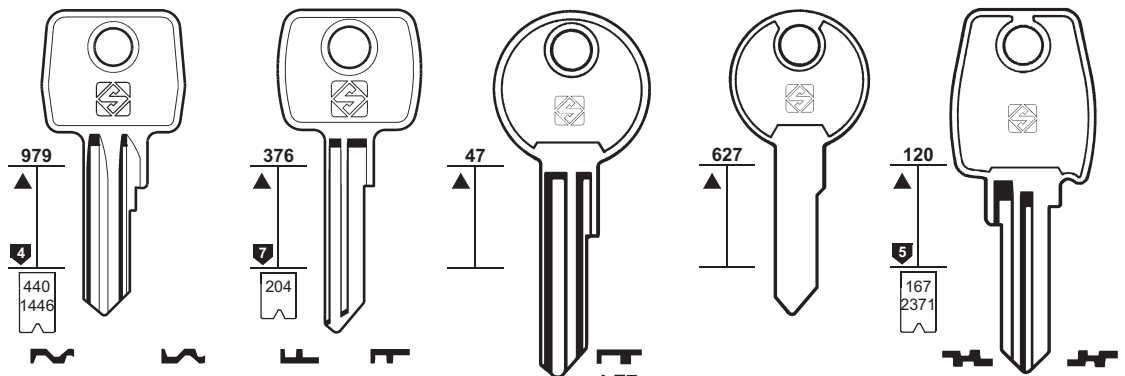

<p>EU4 E 01234 E 1111-4444 405-4324 E 405-4324</p> <p>EU2</p> <p>EU7</p>	<p>EU4R A 01234 A 1111-4444 458-5124</p> <p>EU2R</p> <p>L & F</p>	<p>LF11 76 ... 1-400 70001-71000 M ... 70001-71000</p> <p>LF11R</p> <p>L & F</p>	<p>LF7</p> <p>LF8</p> <p>LF8R</p> <p>L & F</p>	<p>LF29R</p>	<p>LF16</p> <p>LF16R</p> <p>DOUBLE SAFE</p>
---	--	---	--	---------------------	--



71

PER / FOR

EURO LOCKS (B)

BASI
DETHLEF
DOUBLE SAFE
HOBBY
KNAUS
L & F
TRABER
VIOMETAL

+ BASTA (28)
+ CHICAGO (45)
+ L & F (116-117)

EURONORM (D)

CORBIN (53)
 CORNI (55)

EUROP (F)

SUREX (163)

EUROSPEC (GB)

EVERGOOD (RC)

JNF
MERONI
SISO

PER:
FOR:

EURO LOCKS

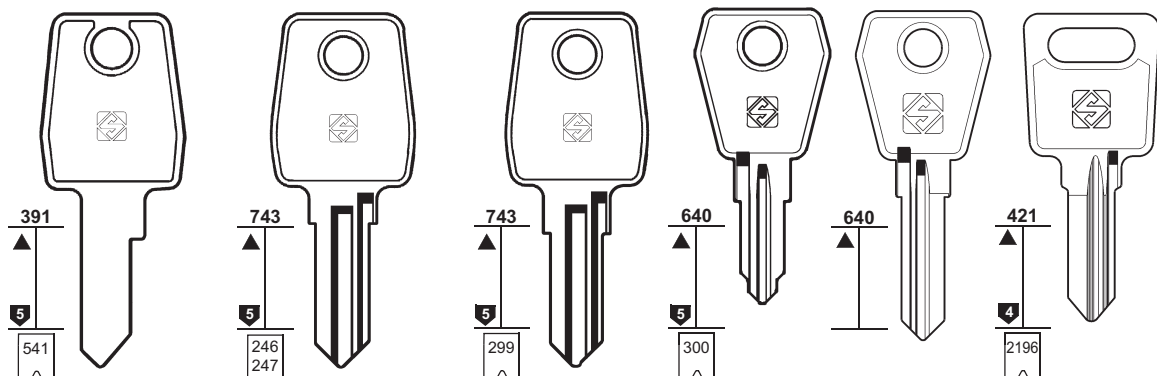

<p>LF13</p> <p>LF17</p> <p>L & F</p>	<p>LF22 93 ... 201-400 93901-94000</p> <p>LF15R 90901-90975</p> <p>EU13R 2001-4000 B 001-1000 C 001-1000</p> <p>L & F</p>	<p>LF22R</p> <p>LF23R 93 ... 401-900 9001-95000 EL 9001-9500 EL 1-500 1001-1100</p> <p>BASI - L & F VIOMETAL</p>	<p>LF20</p> <p>LF20R</p> <p>LF30R 801-900 901-1000</p> <p>EU9</p> <p>L & F</p>	<p>EU16R</p> <p>EU14 IF 1-2-3-4</p> <p>L & F</p>
---	---	--	---	---

PER:
FOR:

EURO LOCKS

EUROSPEC

EVERGOOD

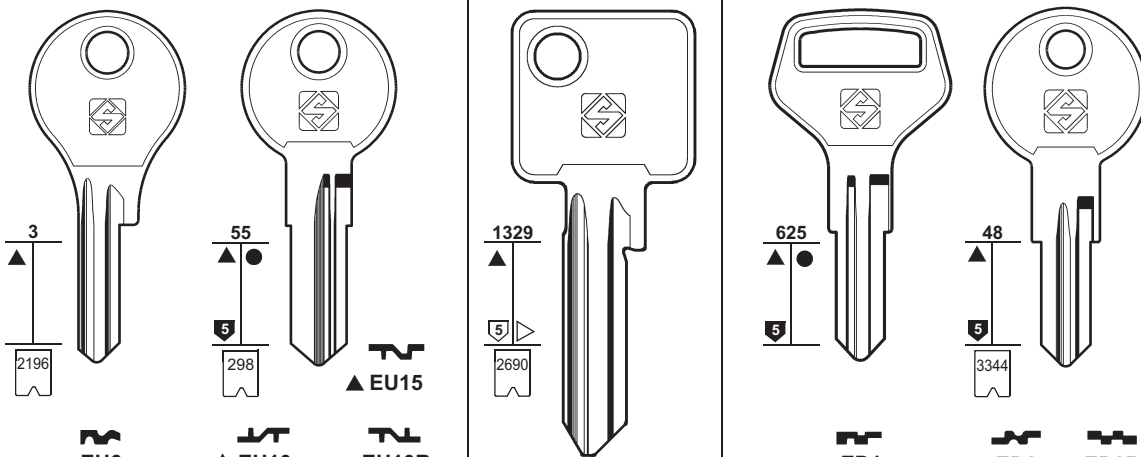

<p>EU6</p>	<p>EU10</p> <p>EU10R 2001-2200</p>	<p>EU15</p>	<p>EUS1 123456</p>	<p>ED1</p>	<p>ED2 MERONI 1-2-3</p> <p>ED3R</p> <p>ED4</p>
-------------------	--	--------------------	-------------------------------------	-------------------	--

DETHLEF - HOBBY
KNAUS - TRABER



JNF - SISO



72

PER / FOR

EVO (GB)
MILA

EVVA (A)
TRYBA

EXCEL (F)
+ SIDLEEN (154)

EXPRES (PL)
LOB (114)

PER: EVO
FOR:

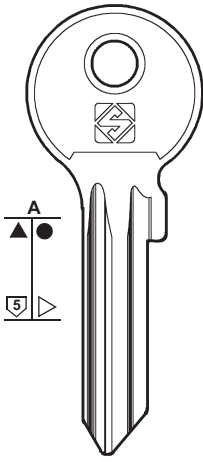

EVO1
MILA

EVVA

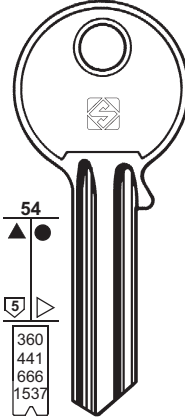

... A 1000-9999
... A . 1000-9999
... A . 1000-9999
... A . 1000-9999
... 1234567890
... 1234567890
XA ... 40000-59999
A ... 5600-9999
... 60001-97000

... C 1000-9999
... C . 1000-9999
... C . 1000-9999
... C . 1000-9999
... () 1234567890
C ... 5600-9999
C ... 60001-97000

EV2
E
 EV3
C
 EV3R
2C
 EV4
F
 EV4R
2F
 EV5
Z
 EV9
BB
 EV10
A
... Z 1000-9999
... Z . 1000-9999
... Z . 1000-9999
... Z . 1000-9999
Z ... 5600-9999
... F 1000-9999
... F . 1000-9999
... F . 1000-9999
F ... 5600-9999

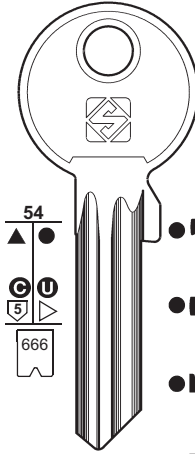

5S ... 40000-59999
S ... 40000-59999
S ... 60001-80000
S ... 98000-99965
 EV3X
C
 EV3RX
2C
 EV4X
F
 EV4RX
2F
 EV5X
Z
 EV9X
BB
 EV2X
E
 EV10X1
A
 EV69X
S
 EV64RX

PER: EVVA
FOR:

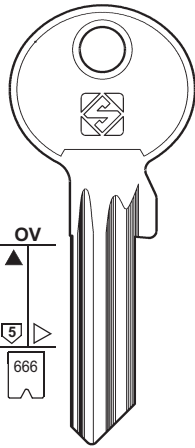

EV10X
A ... 60001-97000
TRYBA

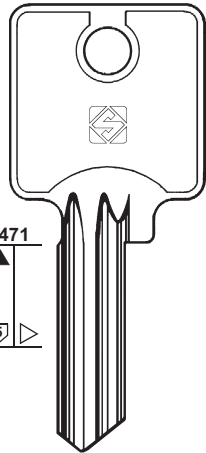

EV11
C

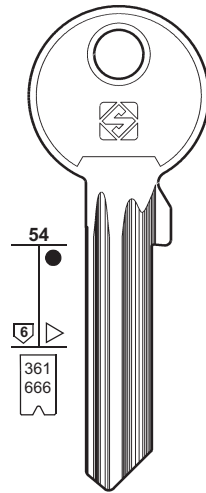

EV12
A

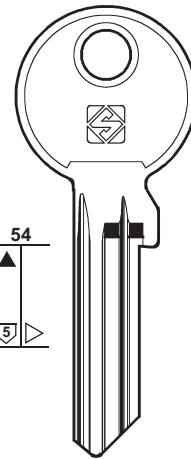

EV81X
6S ...
40000-59999

EV103X-2

EV103X-3
 EV103X-8

EV103X-4
 EV103X-9

EV103X-5
 EV103X-10

EV103X-6
 EV103X-11

EV103X-7
 EV103X-12

PER: EVVA
FOR:

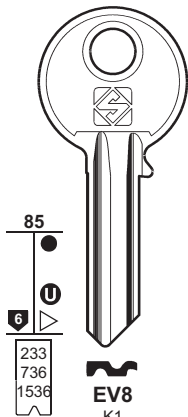

EV8
K1
... 2001-2479
... 1234567890

EV8R
K0
... 1001-1479
... 1234567890

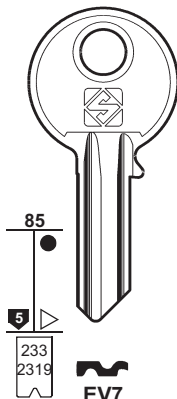

EV7
K1
... 4001-4250

EV7R
K0
... 3001-3250
M ... 3001-3250

EV21R
NM ...
NM2 ...
50000-54999

EV22R
NM ...
NM2 ...
55000-59999

EV23R
NM ...
NM2 ...
60000-64999

EV24R
NM ...
NM2 ...
65000-59999

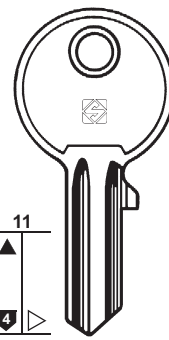

EV6
K1

EV6R
KO

EXCEL

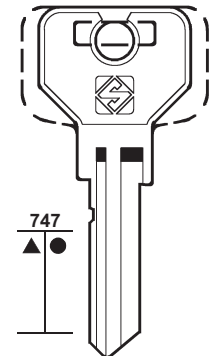

747

EX1

PER:
FOR:

EZCURRA

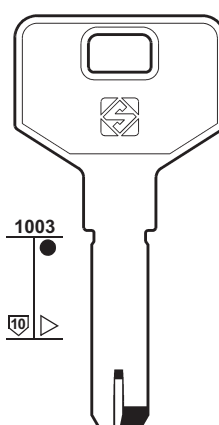
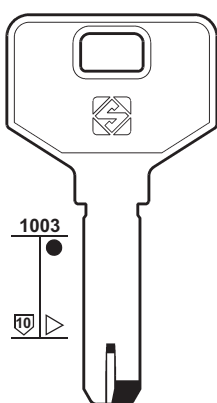
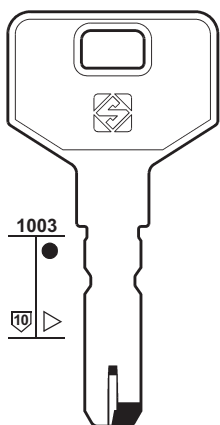
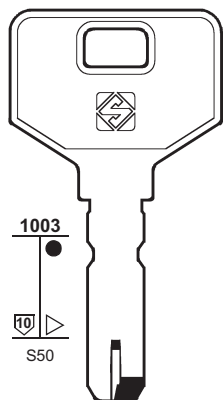

EZ3
DS10

EZ3X
DS10



EZ6
DS15

EZ6X
DS15



73

PER / FOR

EZCURRA (E)
ESAFE
JMR
NAZABAL
+  SEA (152)

E-Z-SET (USA)
 KWIKSET (108)

PER:
FOR:

EZCURRA

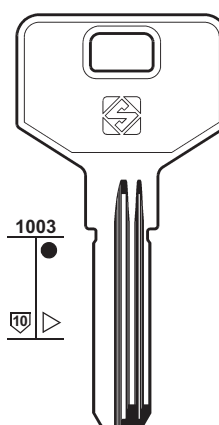
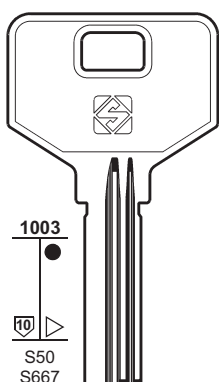
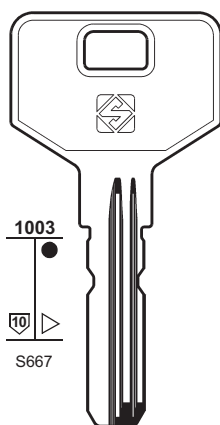
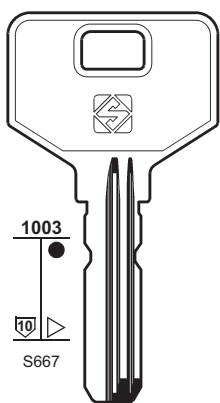

EZ4
DS10-E

EZ4X
DS10



EZ5
DS15-E

EZ5X
DS15

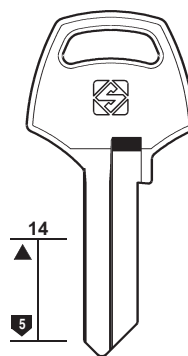
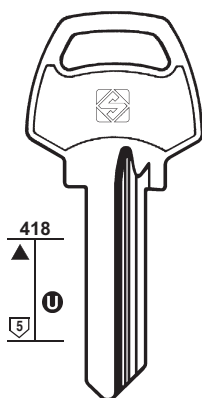
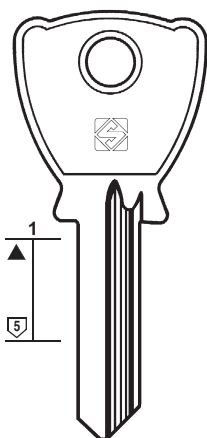

PER:
FOR:

EZCURRA



EZ1

EZ2R

EZ7

NAZABAL

ESAFE - JMR



74

PER / FOR

FAB (CZ)
GUARD
LOB
YETI

PER:
FOR:

FAB

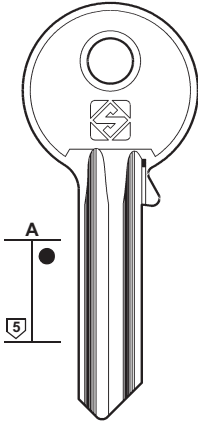

FB26
40

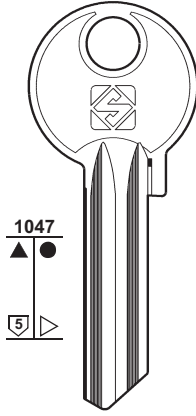

FB26R
40 1/2

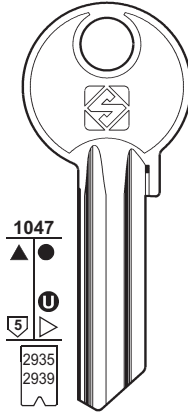

FB23
41



FB23R
41 1/2



FB24
PP
..... 0123456789ABC
..... 0123456789

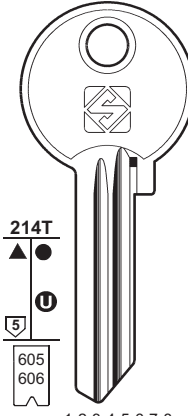

FB24
PP



FB9



FB10R
13



FB11R
15



FB12R
16



11P
FB1



FB33



10P
FB2



FB33R



FB3R



FB42R



FB4R



FB81



FB5R



FB81R



FB6R



FB7R



FB8R

GUARD

GUARD

LOB - YETI

PER:
FOR:

FAB

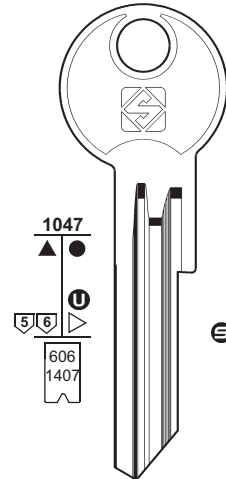

..... 0-1-2-3-4-5-6-7-8
..... 0-1-2-3-4-5-6-7-8

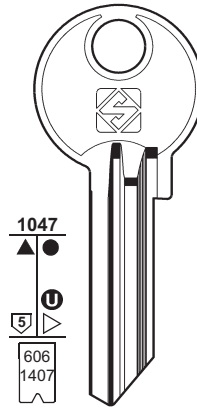

..... 0-1-2-3-4-5-6-7-8
..... 0-1-2-3-4-5-6-7-8



PER:
FOR:

FAB

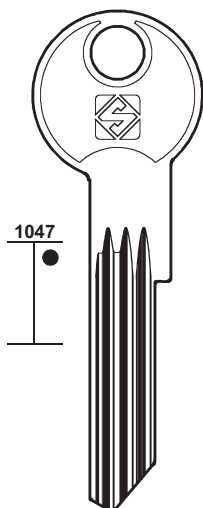

FB64RX
027

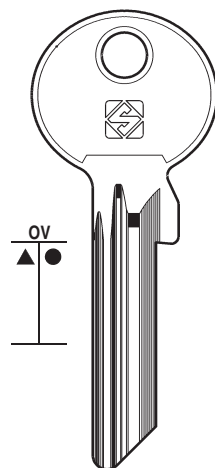

FB64X



FB35R
K

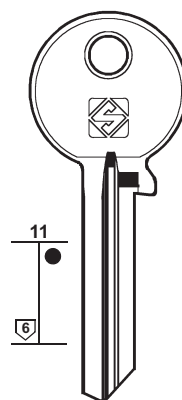

FB65R

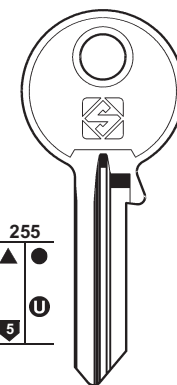

FB34R



FB75R

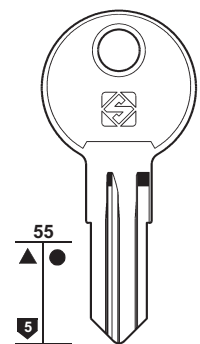

FB36



FB36R



PER:
FOR:

FAC

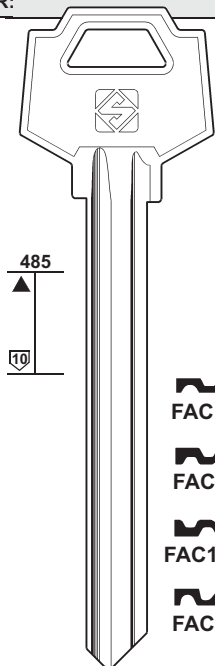

FAC1R
FAC10
FAC10R
FAC11●

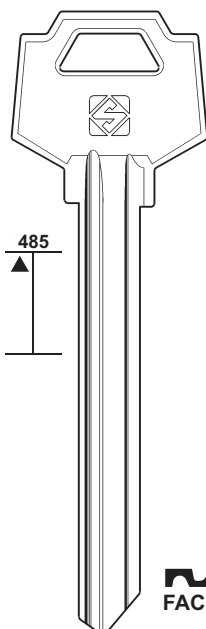

FAC14

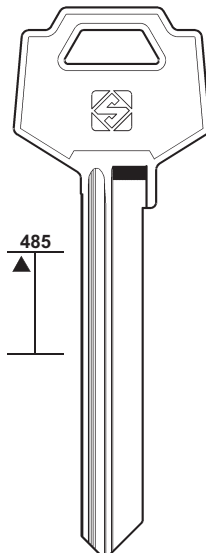

FAC12

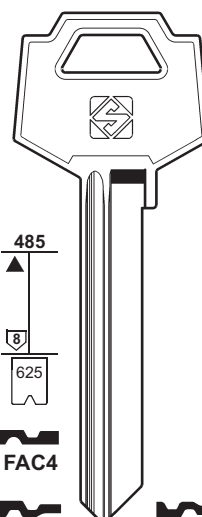

FAC4
FAC6
FAC9
FAC6R
FAC13

0123456789



75

PER / FOR

FAC (E)
ARREGUI
INDAUX

PER:
FOR:

FAC

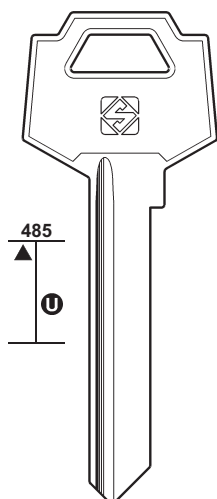

FAC7
FAC8

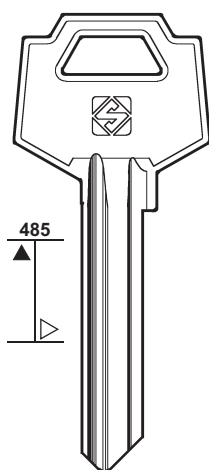

FAC30

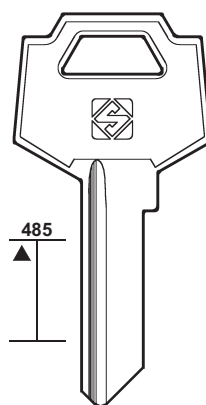

FAC29

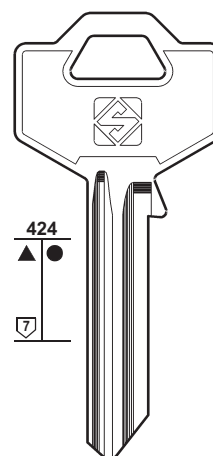

FAC5R
FAC5

PER:
FOR:

FAC

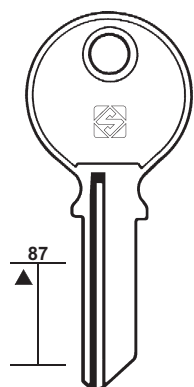

FAC3R
FAC3

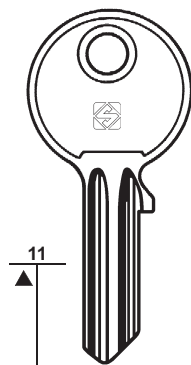

FAC2R
FAC2

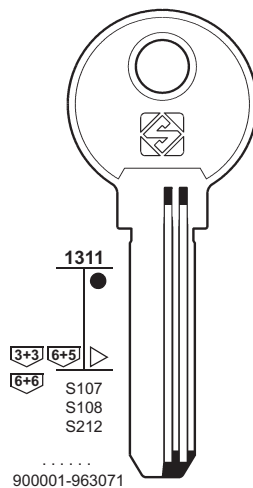

900001-963071

FAC15

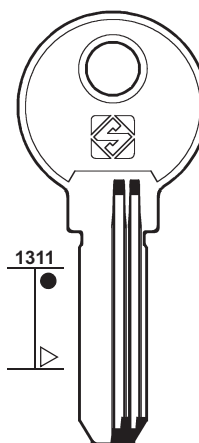

FAC31



76

PER / FOR

FAI (I)
VIRO
+ VIRO (186)

FALCON (USA)
WEISER
+ BEST (29)

FAMA (I)

FAMA (BR)

FANA (PL)
+ BRUMME (36)

FARCE (F)
+ MELSMETAL (122)

FAS (S)

PER:
FOR:

FAI

FAI1R FAI2 FAI3

VIRO VIRO

FALCON

FN1 FN2 FN4

WEISER

PER:
FOR:

FAMA (I)

FAM1 FAM1R ▲ FAM2R

FAMA (BR)

FAM6 FAM3

..... 1-2-3-4-5-6-7-8-9-0-A

PER:
FOR:

FAMA (BR)

FAM9 FAM5 FAM8

..... 1234567890

FANA

FAN1

..... 123456789ABC

FAS

FS1 FS1R

PER:
FOR:

FASEM

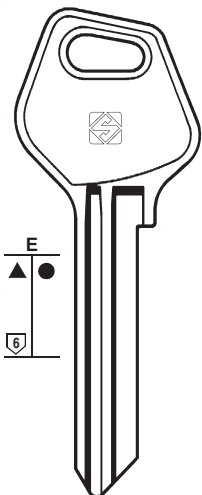

FM7

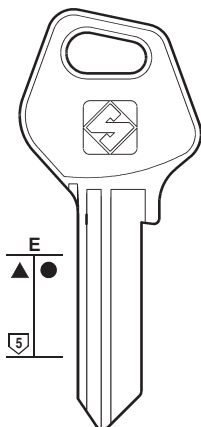

FM6

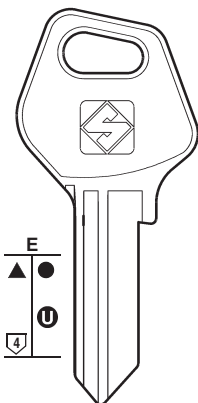

FM1

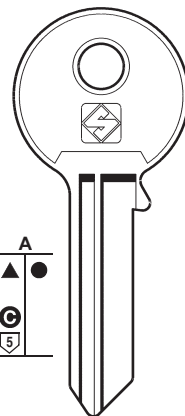

FM090

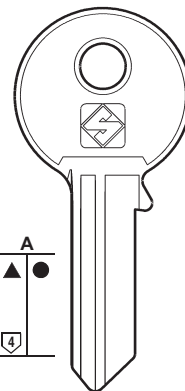

FM2

ILS
IULIA MAS FED

FPB



77

PER / FOR

FASEM (I)
BERETTA
BV
FPB
ILS
IULIA MAS FED
JUWEL
+ BIELLE (30)

PER:
FOR:

FASEM

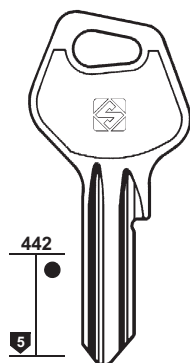

FM5

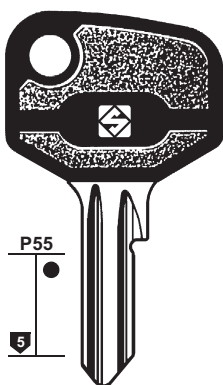

FM5P

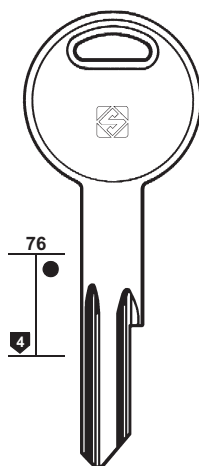

FM8

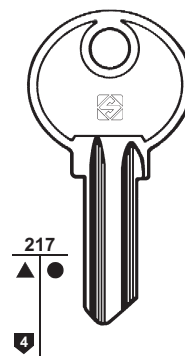

▲ FM4 FM4R

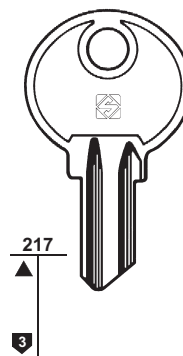

FM3 FM3R

BERETTA - BV

JUWEL

JUWEL

FASMA (I)
 EURO LOCKS (71)

FATTORINI (I)
 PREFER (142)

FAVOUR (DZ)

FAYN (TR)

FB (E)
 AGA (11)

FBC (I)
 GIUSSANI (86)

PER:
FOR:

FAVOUR

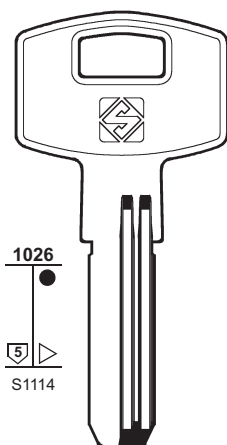

FVR1

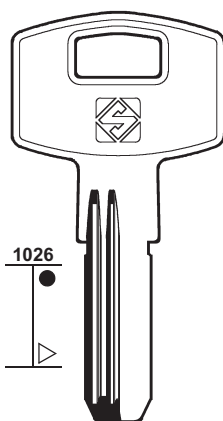

FVR2R

FVR4R

FVR3

FAYN

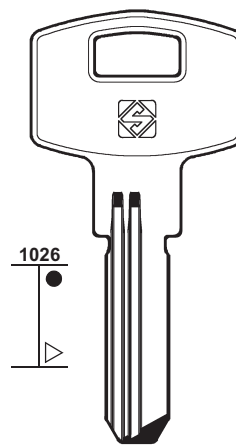

FY1R





78

PER / FOR

FCV (D)

- KFV
- VBH
- + KfV (105)

FEB (I)

- + ALPHA (15)
- + CORBIN (53)
- + JVAL (102)
- + MORI E. (129)
- + P.C. (CORTELLEZZI) (139-140)
- + VIRO (186)

FEDERAL (F)

- + FTH (82-83)
- + JUNKUNC (101)

FEFI (D)

- + CES (42)

FEL (D)

- + SIS (156)

FERCO (F)

- + YALE (195)

FERMABLOCK (I)

- + OLIVA (134)

FERONERIA (RO)

F.F. (I)

- + GUARDIAN

PER:
FOR:

FCV

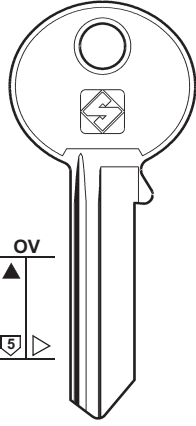

FCV1

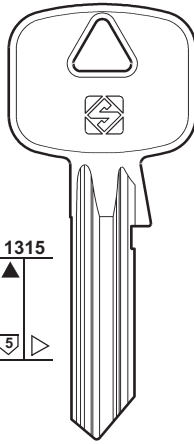

FCV2

KFV

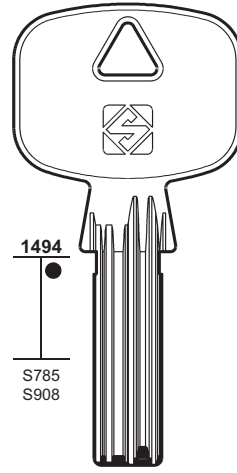

FCV4



KFV - VBH

FEB

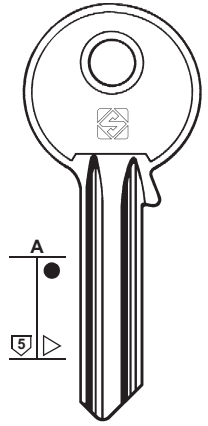

FEB2 FEB2R

PER:
FOR:

FEB

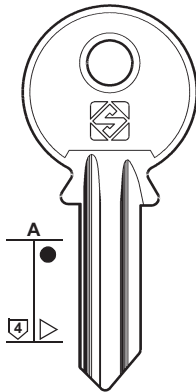

FEB1

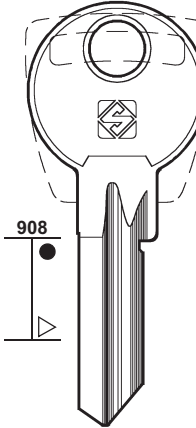

FEB1R



FEB6R

FEDERAL

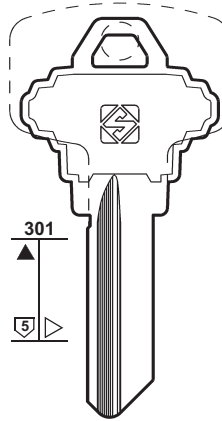

FDR1

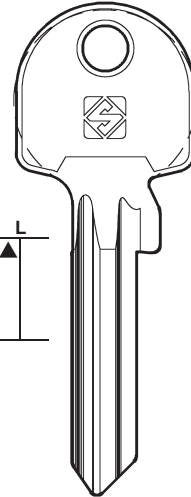

FDR2

FERONERIA

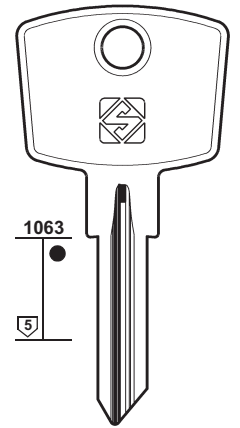

FRN1R

PER:
FOR:

F.F.

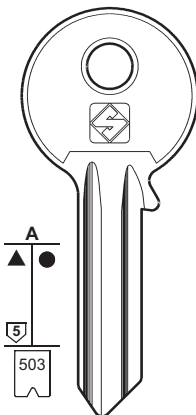

FF1

.....0-1-2-3-4-5-6-7

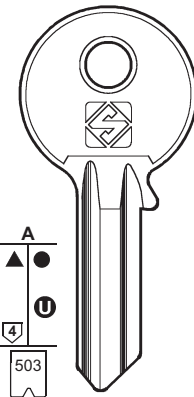

FF2

.....0-1-2-3-4-5-6-7

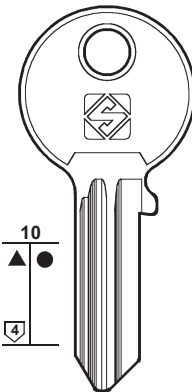

FF15

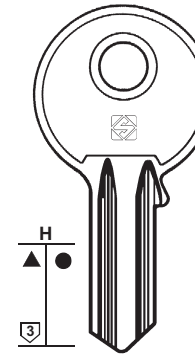

FF3



FF3R

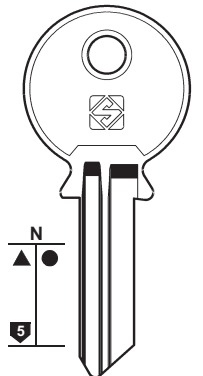

FF14



FF8



FF8R



FF9



FF9R



FF10



FF10R



FF17



FF7



FF7R

GUARDIAN

GUARDIAN

PER:
FOR:

F.F.

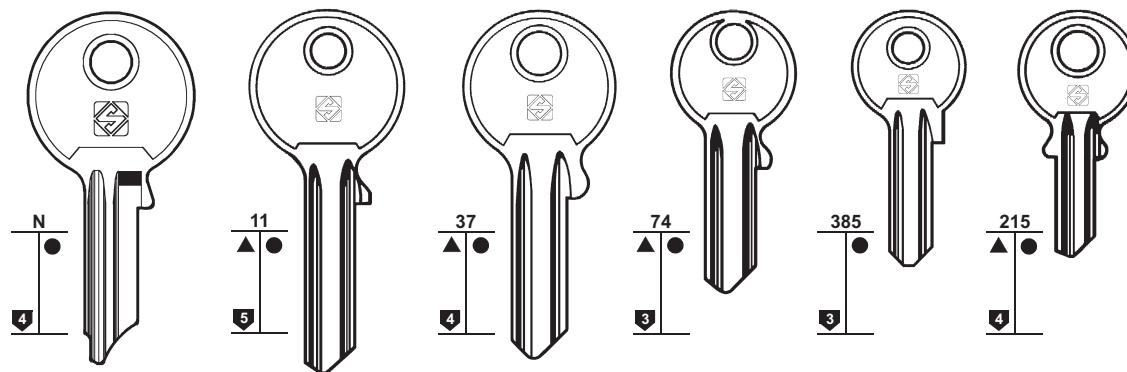

FF18

FF4

● FF4R

FF12

FF12R ▲

● FF5

FF13

● FF6

FF11

FF11R

FF5R

FF13R

FF6R



79

PER / FOR

F.F. (I)

FIAM (I)

+ KESO (105)

FIK (KSA)

+ ZANI (200)

PER:
FOR:

F.F.

FIAM

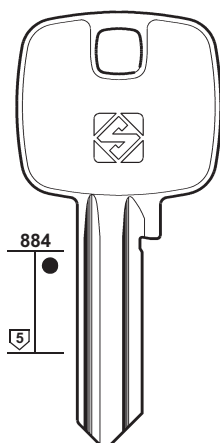

FF16

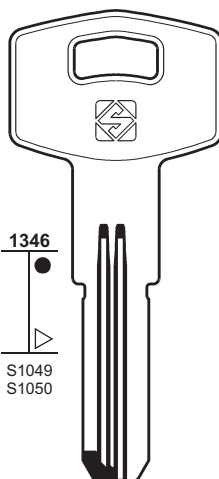

FI3R

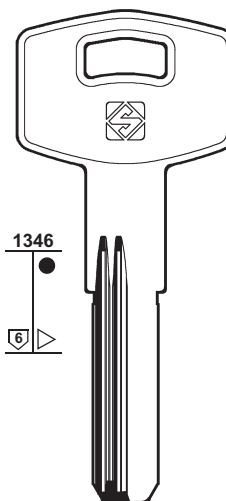

FI4R



PER:
FOR:

FIAM

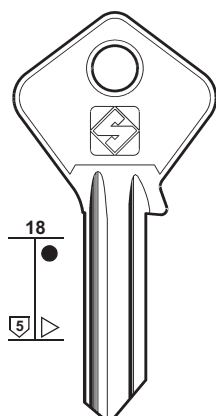

FI234

FI235

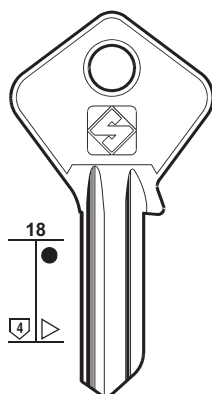

FI232

FI233

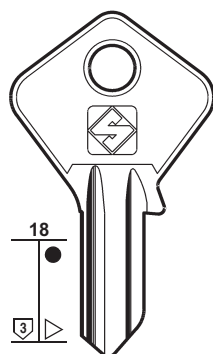

FI1

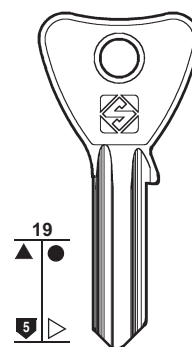

● FI064

FI065



80

PER / FOR

FICHET (F)
SURFINOR
TECNOR
+ TOK-WINKHAUS (171)

FIMANEVSKI (RUS)
DNEPROPETROVSK
(59)

FIRMADOOR (AUS)

FIRST (CH)

FIS (I)

PER:
FOR:

FICHET

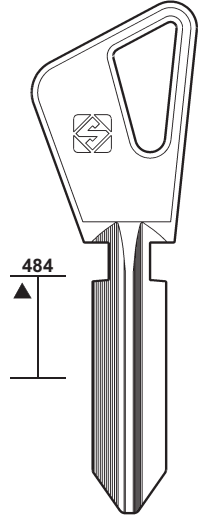

484

FT4



SURFINOR

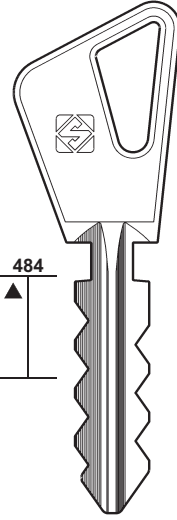

484

FT4C



SURFINOR

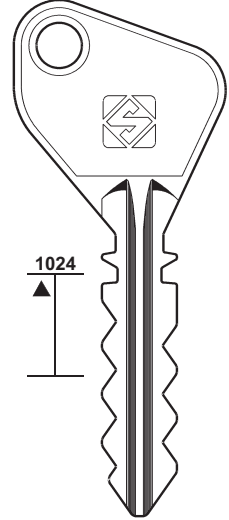

1024

FT5C



PER:
FOR:

FICHET

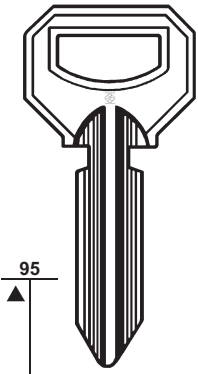

95

FT3



TECNOR

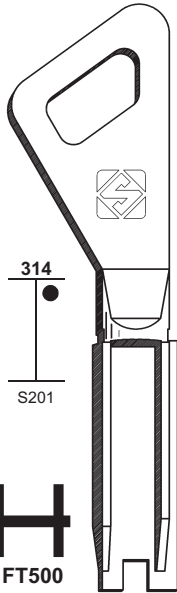

314

S201



FT500

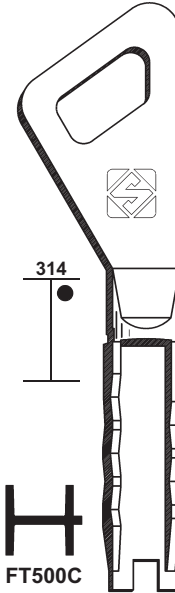

314



FT500C

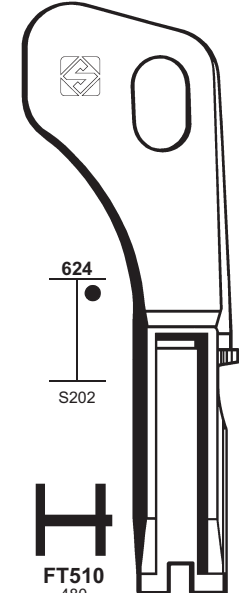

624

S202



FT510
480

PER:
FOR: FIRMADOOR

FIRST

FIS

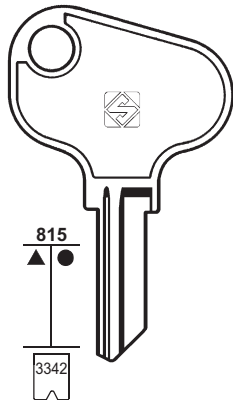

815

3342



FID1
B... 1-100

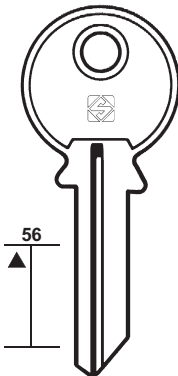

56



FIR1

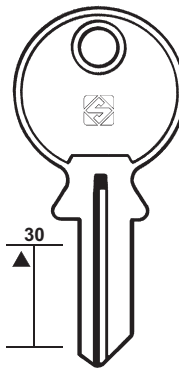

30



FIR3

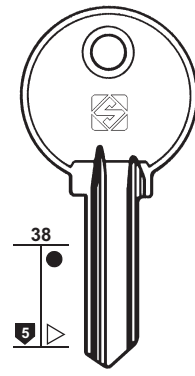

38

5



F1

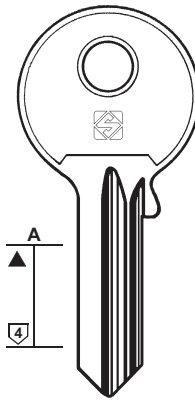

A

4



F2R

PER: FOR:	FIST	FLIK	FLIM	FLORA
				FLOHR - NB NORTHWEST - SUKI

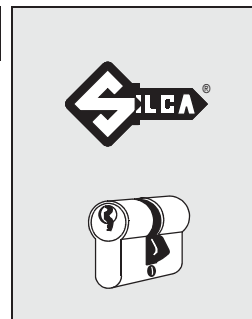

81

PER: FOR:	FONDAR	FORT				
		<p>H 6001-6250 RM 7001-7200</p> <p>OT</p>	<p>HUDSON</p> <p>DAD - DECAYEUX - EMKA SECURITAL - UTZ</p> <p>ARFE</p> <p>DAD</p>			

PER: FOR:	FORTIS	FRANZEN	FRANZMAR		FTH

PER / FOR
FIST (I)
FLAMBO (D) 👁️ DOM (61)
FLIETHER (D) 👁️ KJV (105)
FLIK (D) + 👁️ GEGE (84)
FLIM (RUS)
FLOHR (D) 👁️ FLORA (81)
FLORA (D) FLOHR NB NORTHWEST SUKI
FO (F) 👁️ CITY (51) 👁️ MONOBLOC (128) 👁️ ZENITH (201)
FONDAR (I) OT
FONTAINE (F) 👁️ CORNI (55) 👁️ RONIS (146) 👁️ VACHETTE (181)
FORINDEX (F) 👁️ RONIS (146-147)
FORT (USA) ARFE DAD DECAYEUX EMKA HUDSON SECURITAL UTZ + 👁️ ABUS (9) + 👁️ ARROW (18) + 👁️ CHICAGO (45-46) + 👁️ LAS (110)
FORTIS (E) LBLM
FORTSCHRITT (D) 👁️ DOM (62) 👁️ ZEISS-IKON (201)
FOSAM (I) 👁️ PREFER (143)
FOUR-CIRCLE (RC) 👁️ YETI (198-199)
FPB (I) 👁️ FASEM (77) 👁️ P.C CORTELLEZZI (139)
FRAL (P) 👁️ P.C. CORTELLEZZI (139)
FRANZEN (USA)
FRANZMAR (BR)
FRECOV (D) 👁️ CES (41-42)
FTH (F)



82

PER / FOR

FTH (F)

- CF
- CIB
- CIBC
- CITY
- DIAMA
- FEDERAL
- GISS
- GPR
- HUNIT
- IFAM
- JL
- NICO
- PICARDIE
- PROBAT
- SAMA
- SUF
- + 👁️ ABUS (8)
- + 👁️ BRUMME (36)
- + 👁️ CAS-CISMA (40)
- + 👁️ GLOBE (88)
- + 👁️ TITAN (168)

PER:
FOR:

FTH

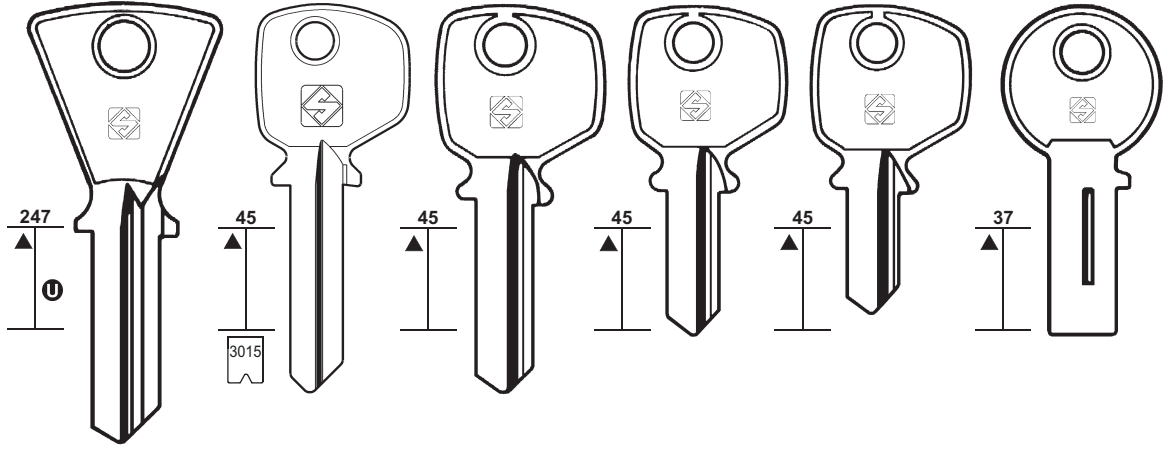

PER:
FOR:

FTH

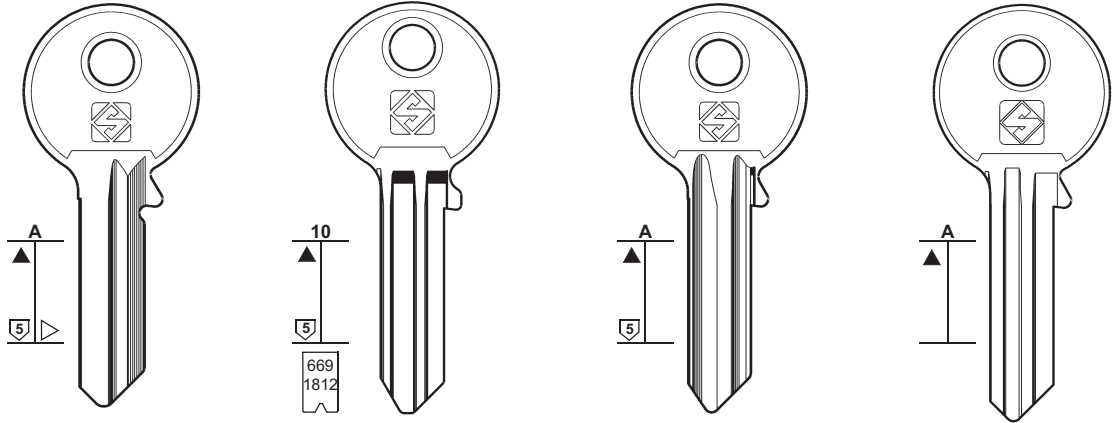

..... A
..... A (NEW)
123456789

CITY - DIAMA - GISS - GPR
HUNIT - PICARDIE - SAMA

CF - CIB - IFAM - JL
NICO - PROBAT

PER:
FOR:

FTH

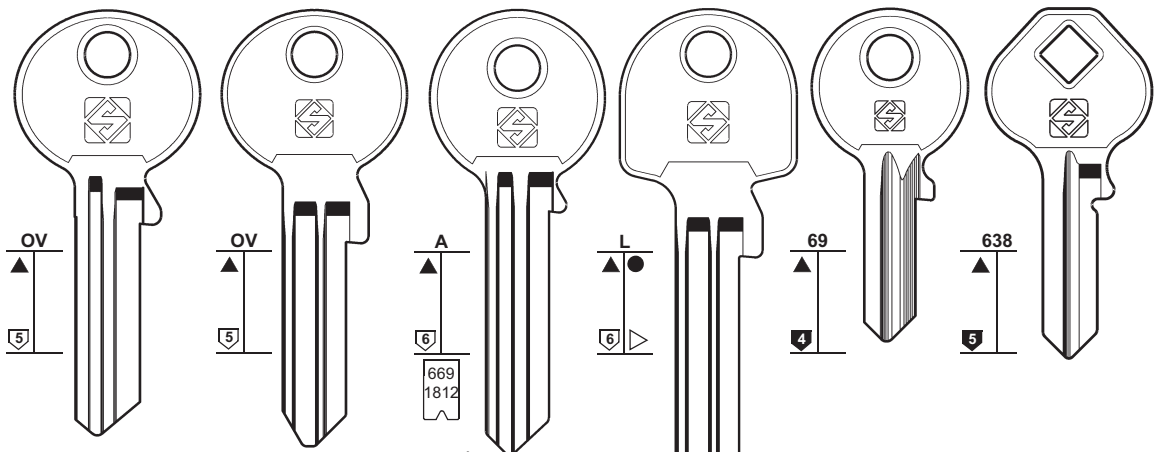

..... A
..... A (NEW)
123456789



CIBC - CITY - SUF



FEDERAL

PER:
FOR:

FTH

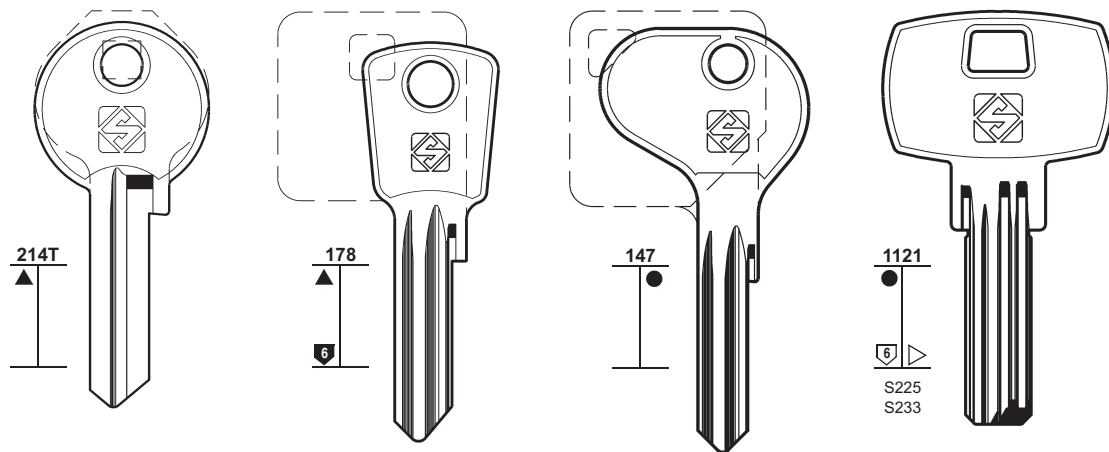

FH23R

FH21R FH22R

FH24R

FH12



83

PER / FOR

FTH (F)
 CODEM
 FEDERAL
 GOTTA
 IFAM
 ITO
 KARO
 SP
 TOVER
 YALTRES
 + ABUS (8)
 + BRUMME (36)
 + CAS-CISMA (40)
 + GLOBE (87)
 + TITAN (167)

FUHR (D)
 CES (42)
 JOWIL (100)

FULLEX (F)
 GEGE (85)

PER:
FOR:

FTH

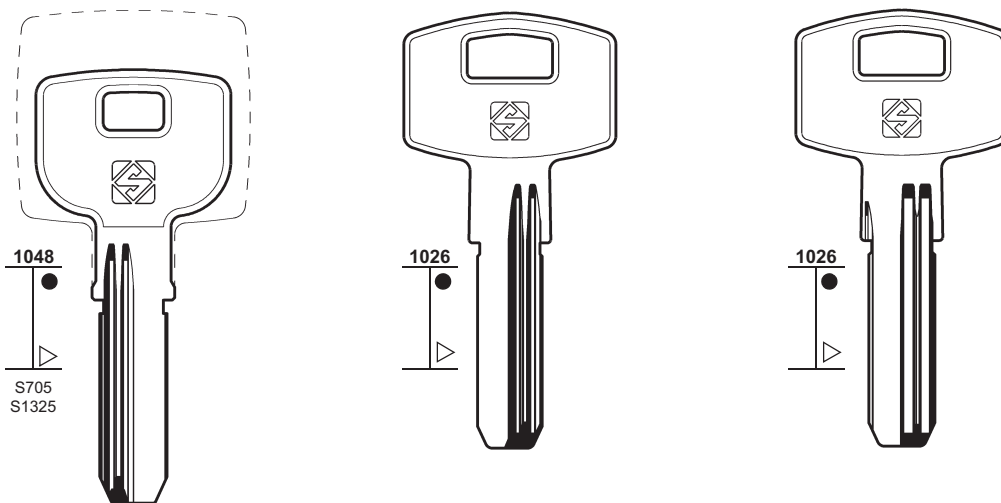

FH17R

FH37R

FH32

FH33

..... 1-2-3-4-5

IFAM
KARO

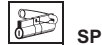

PER:
FOR:

FTH

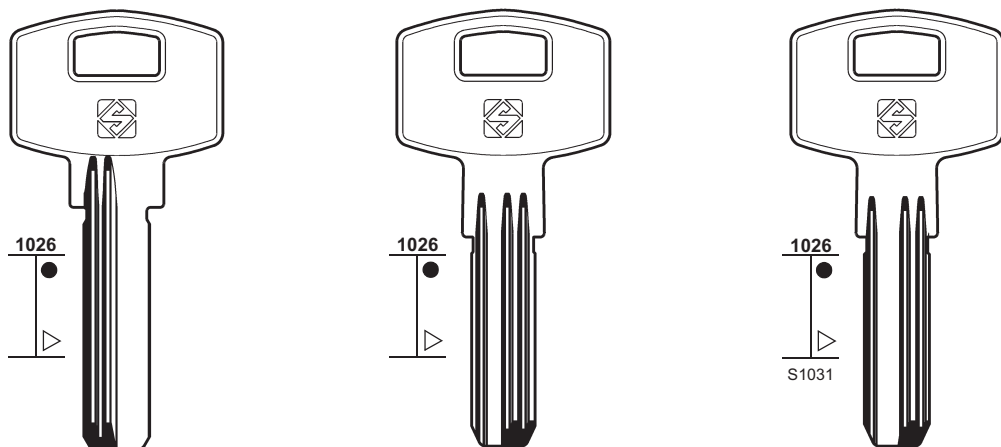

FH34R

FH35

FH36

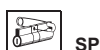



84

PER:
FOR:

GABON

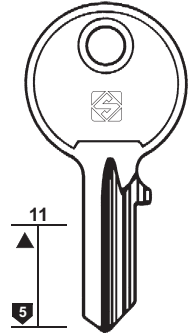
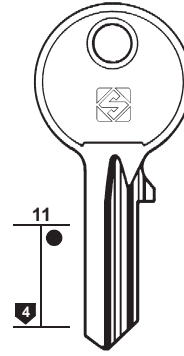
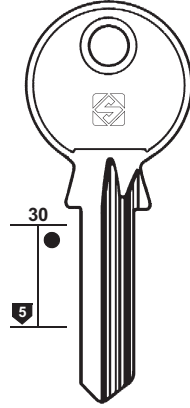
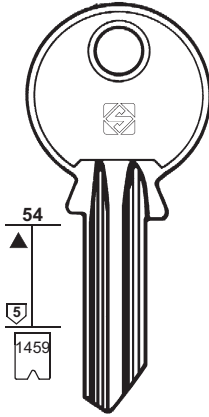

● GB5R



GB5

B... 2000-7700



GB1



GB3



GB2

CHG - DESPREZ - GALLUS
JOLY - MAXIGARD - PICARDIE
SOS - SUREX - WINNER

CHG - GALLUS - MAXIGARD
PICARDIE - SOS - WINNER

PER / FOR

GABON (F)

CHG
DESPREZ
GALLUS
JOLY
MAXIGARD
PICARDIE
SOS
SUREX
WINNER

GAINSBOROUGH (AUS)

LOCKWOOD (115)
TESA (165)

GALLUS (F)

GABON (84)

GARI (E)

AGA (10)

GARRISON (GB)

MUL.TLOCK
(130-131)

GB (F)

GBS (D)

GEA (I)

GEBA (D)

+ BKS (30)

GEBRO (D)

CORONA (55)

GEFI (D)

CISA (48)

GEGE (A)

ABUS
FLIK
FULLEX
GLOSTAL
GRUNDMANN
HÖHRMANN
PEROHAUS
TZAFRER
+ ABUS (6)

PER:
FOR:

GB

GBS

GEA

GEBA

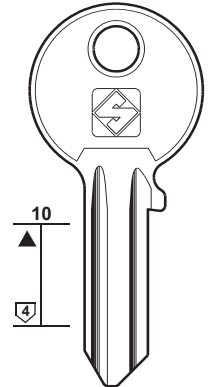
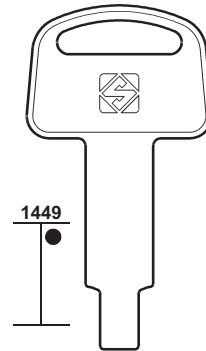
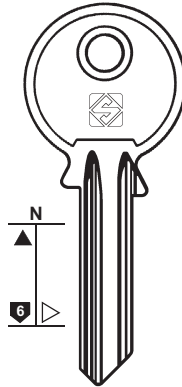
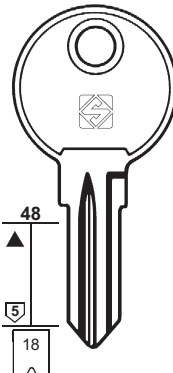

K18

W...



K18R

Z...



K110

Y...



K110R

C...

1-224



WK3



GEA4



GBA1

PER:
FOR:

GEGE

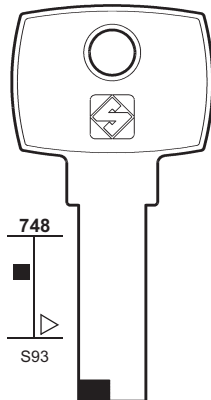

Z...
101-120

GE57

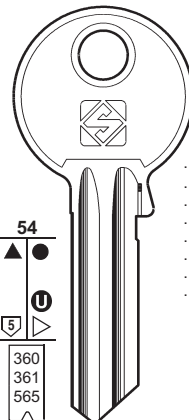

GE1

FULLEX
GLOSTAL
GRUNDMANN
HÖHRMANN
PEROHAUS

..... 000000-210079

..... (.) 1234567890

..... () 1234567890

..... 1234567890ABCDEF

..... () 1234567890ABCDEF

..... 5000001-5067680

..... 500001-545303



▲ GE4



GE4R

GE4R

GE4R

GE4R

GE4R

GE4R

GE4R

GE4R

GE4R

GE4R

GE4R

GE4R

GE4R

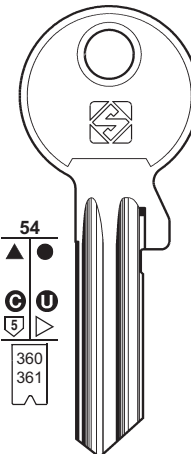

..... 5000001-545303

..... (.)

1-2-3-4-5-6-7-8-9-0

GE1X

▲ GE52X

● GE119X

● GE4RX

● GE7RX

● GE34X

● GE4X

● GE1RX

ABUS - FLIK - TZAFRER

Copyright by Silca S.p.A. 2013 - All rights reserved

PER:
FOR:

GEGE

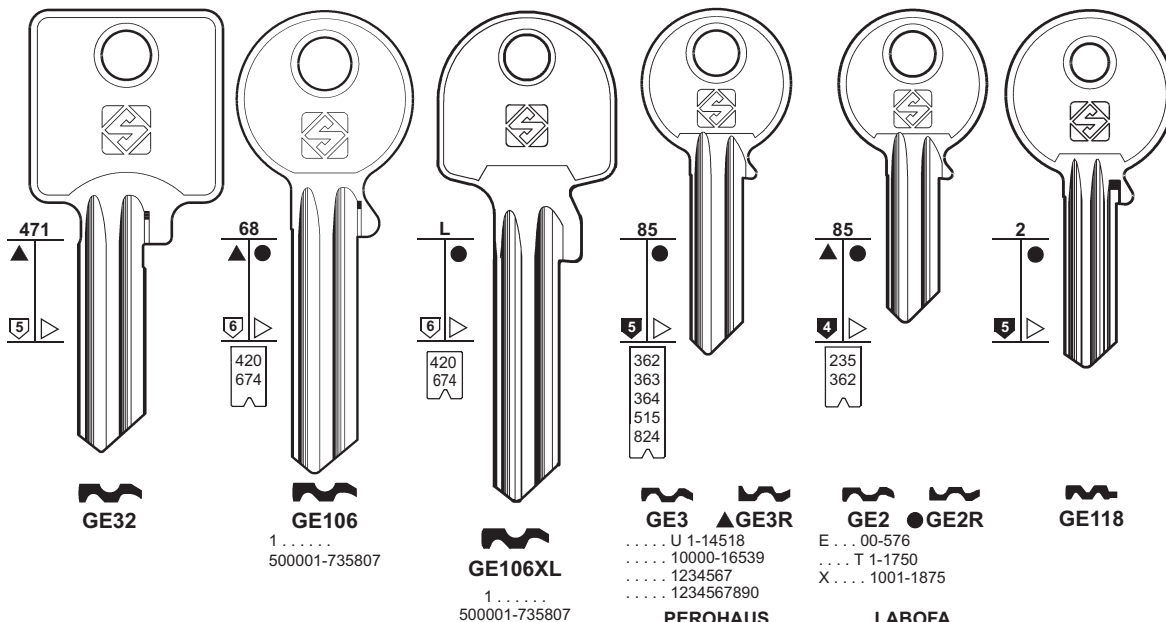

85

PER / FOR

GEGE (A)
LABOFA
PEROHAUS
+ ABUS (7)

GEM (USA)
CHICAGO (46)

GENTILI (I)
CILA (47)

GERA (D)
+ BUVA (39)
+ SATURN (151)
+ STARLET (161)

GETE (D)
CISA (48)

PER:
FOR:

GEGE

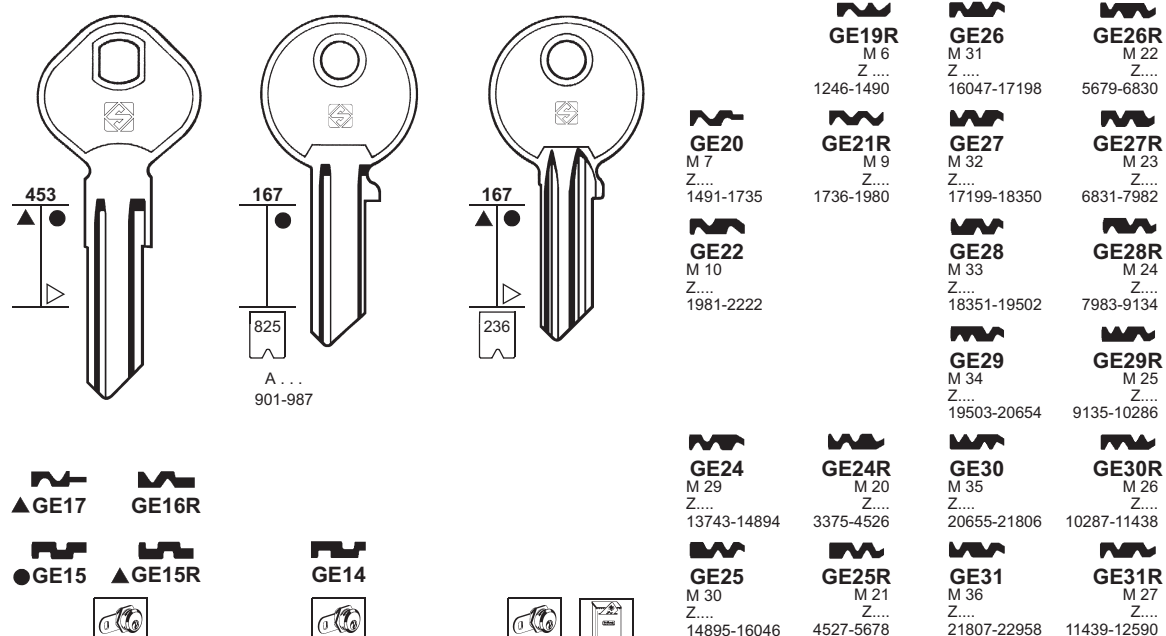

PER:
FOR:

GERA

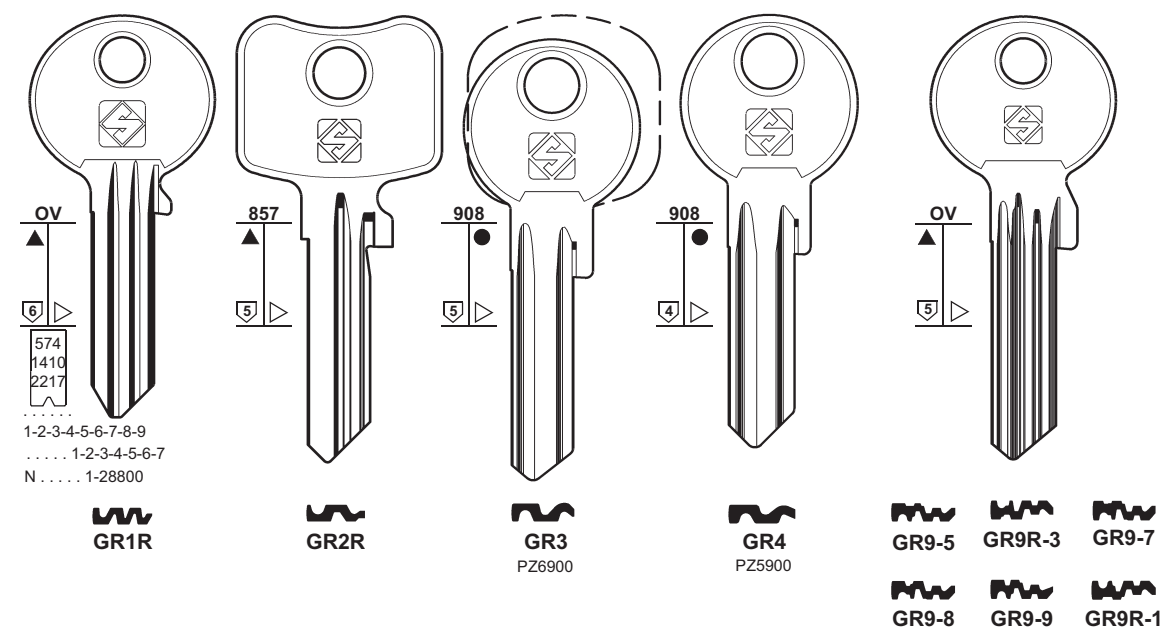



86

PER / FOR

GEVY (GR)
MOTTURA
+ CISA (48)
+ DELCA (58)
+ P.C.
CORTELEZZI (140)

GEWIRU (D)
 DOM (61)

GEWISS (I)

GHE (D)
 EMKA (69)
 LA PORTE (110)

GHIDINI (I)
 ZANETTI A. (200)

GIESCHE (GB)
 CES (42)
 KFV (105)

GIMM (F)
 RONIS (147)

GIOBERT (I)
OLIVETTI

GIBBONS (GB)
WILLENHALL

GIP (F)

GISS (F)
 FTH (82)

GIUSSANI (I)
BRETER
CAB
ELSA
ELVOX
FBC
LUME
METALCASTELLI
MLP
OAL
PLG
SIMECA
+ BRETER (34)
+ TITAN (167)

PER: **GEVY**

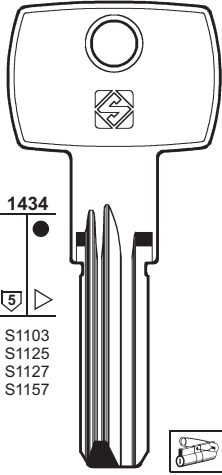

1434

5

S1103
S1125
S1127
S1157



GVY1R

..... 600001-613040
..... 900001-902780

MOTTURA

PER: **GEWISS**



385

3



GWS1



PER: **GIOBERT**

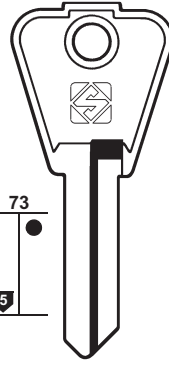

73

5



GT4



GT4R

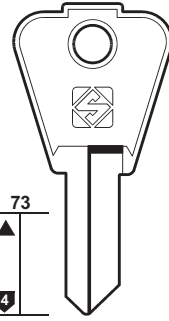

73

4



CM2



CM2R

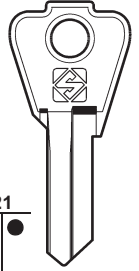

21

5



GT1



GT1R



PER: **GIOBERT**

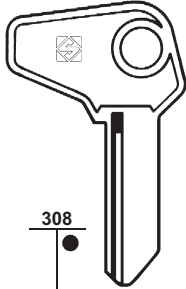

308

5



GT3

E



GT3R

F

OLIVETTI



PER: **GIBBONS**

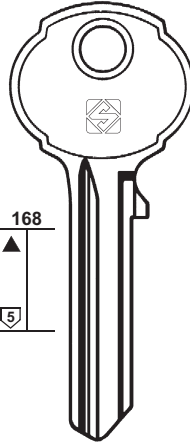

168

5



GN1

WILLENHALL

PER: **GIP**

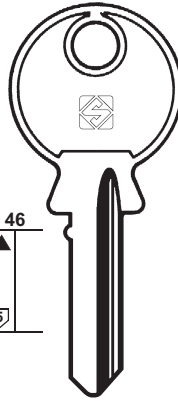

46

5



GP1

PER: **GIUSSANI**

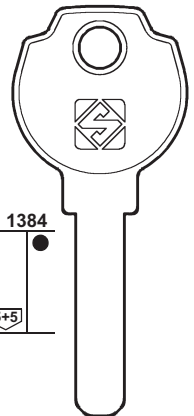

1384

5+5



GS17



PER: **GIUSSANI**

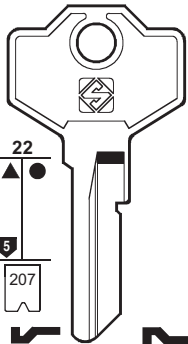

22

5

207



GS1



GS4R

E...9001-9741



SM1R



GS9

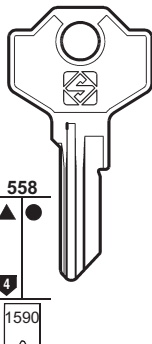

558

4

1590



GS1R



GS4

E...3001-3480



SM1

..... 9001-9741
G... 3001-3480
..... 3001-3480
G...9001-9741
G...0-480

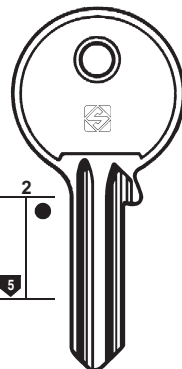

2

5



GS3



GS3R

..... 1-2-3-4



GS13



BRETER

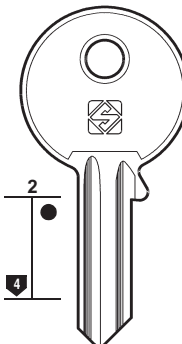

2

4



GS2



GS2R

..... 1-2-3-4



GS10



FBC - MLP

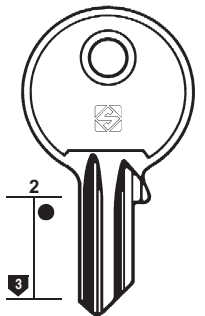

2

3



GS10



GS10R

..... 1-2-3-4



GS10R



METALCASTELLI

CAB - ELSA - ELVOX
PLG - SIMECA

OAL - LUME

BRETER

FBC - MLP

METALCASTELLI

PER:
FOR:

GIUSSANI

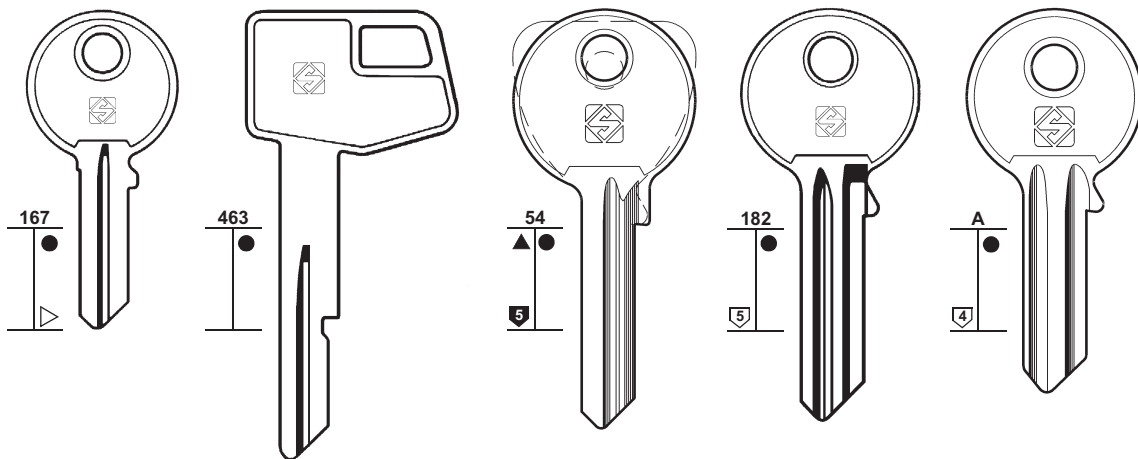

GS12R

GS11R

GS5

GS6

GS8

GS7



MLP



BANKA



PASTORE



87

PER / FOR

GIUSSANI (I)

- BANKA
- MLP
- PASTORE
- + BRETER (34)
- + TITAN (167)

GLAZIEV (RUS)

GLOBAL (GB)

GLOBE (RC)

- ANLO
- GOLD-DOOR
- LARK
- LUCO
- MIAN-FORCE
- SOF
- WHALE
- + GOLD DOOR (89)
- + HILLO (93)

PER:
FOR:

GLAZIEV

GLOBAL

GLOBE

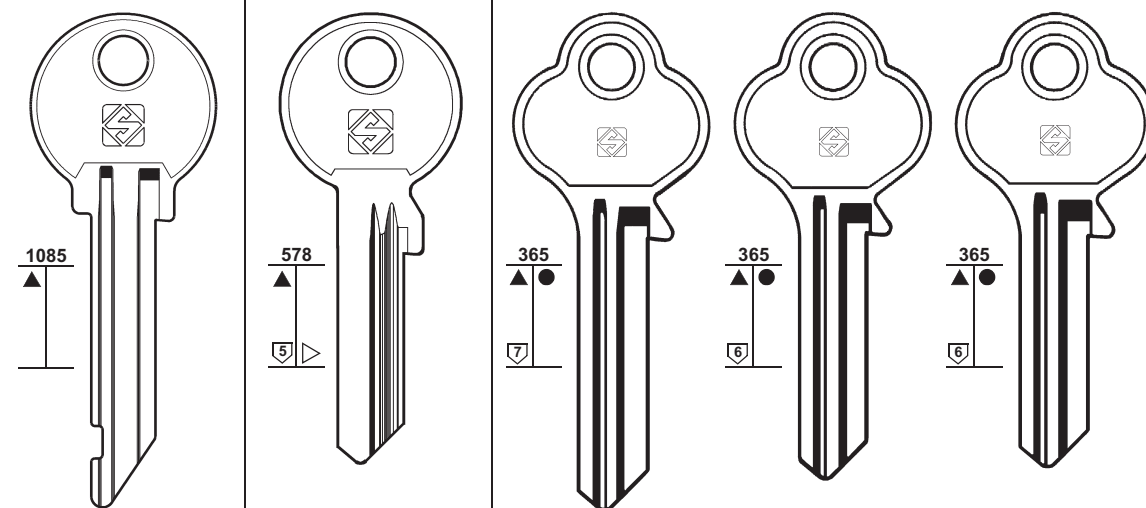

GLZ1

GBL1R

GL8

GL7

GL7R

GL6

GL6R



LARK



WHALE

PER:
FOR:

GLOBE

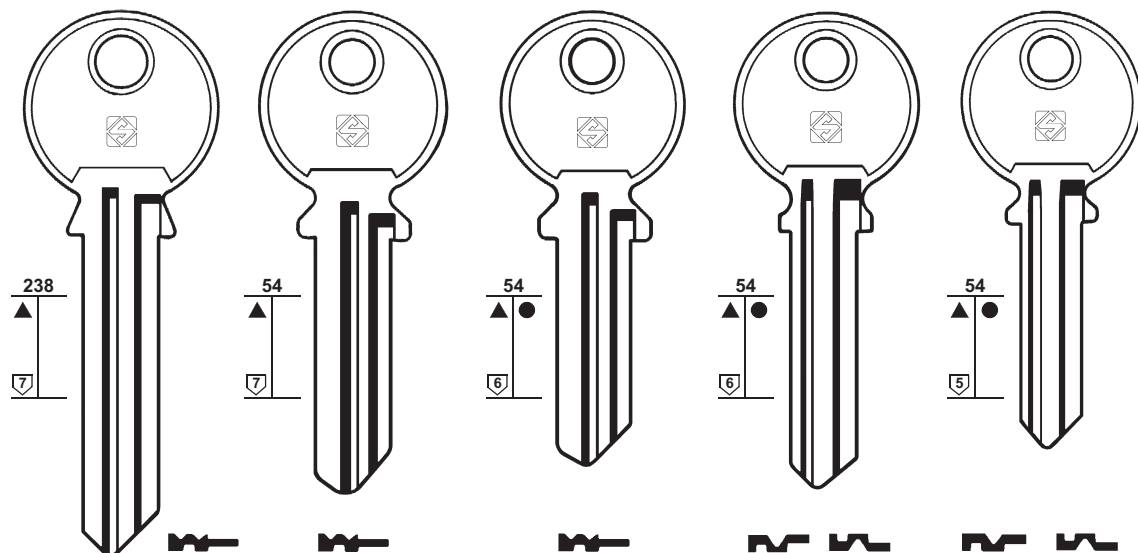

GL11R

GL12R

GL13R

GL9

GL9R

GL10

GL10R ●



MIAN-FORCE



SOF



GOLD-DOOR



ANLO - LUCO



88

PER / FOR

GLOBE (RC)

DOFIN

FTH

GOLD-DOOR

IFAM

SOF

+ GOLD DOOR (89)

+ HILLO (93)

GLOSTAL (D)

+ GEGE (84)

GOAL (J)

+ GSS (90)

PER:
FOR:

GLOBE

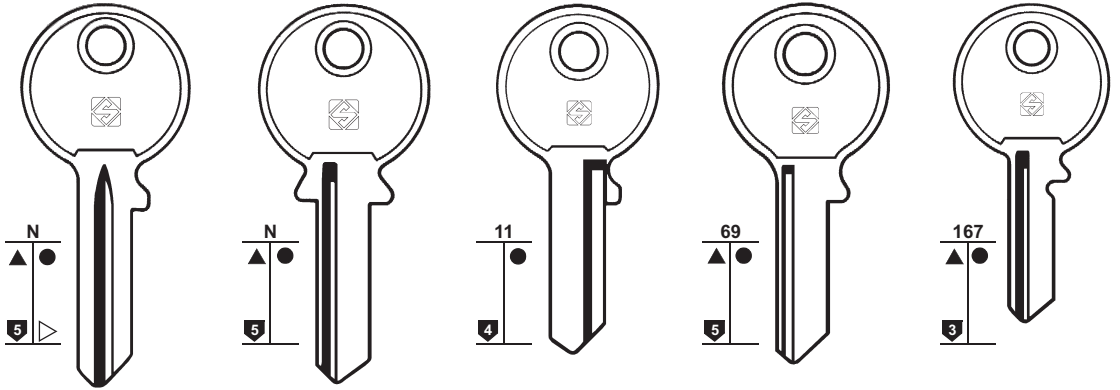

GL4



GL3R



GL5



GL2R



GL4R



GL3



GL5R



GL17R



GL2



DOFIN - FTH
GOLD DOOR
SOF



IFAM

PER:
FOR:

GLOBE

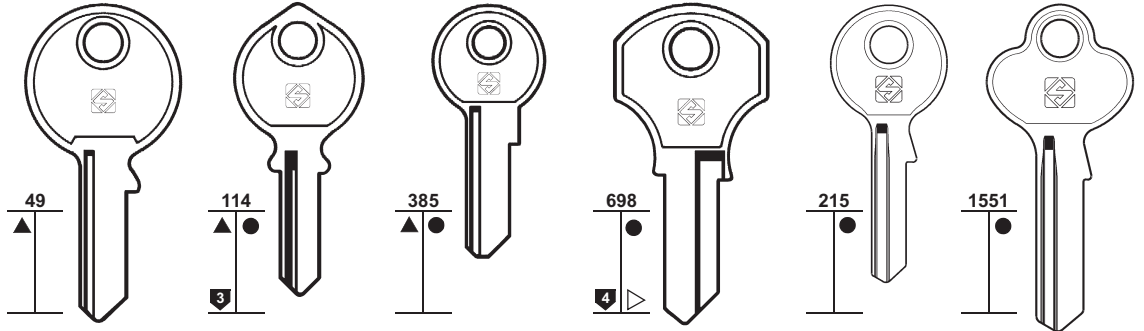

GL18R



GL1R



GL1



GL19R



GL14



GL21R



GL22R



GOLD-DOOR



PER:
FOR:

GOAL

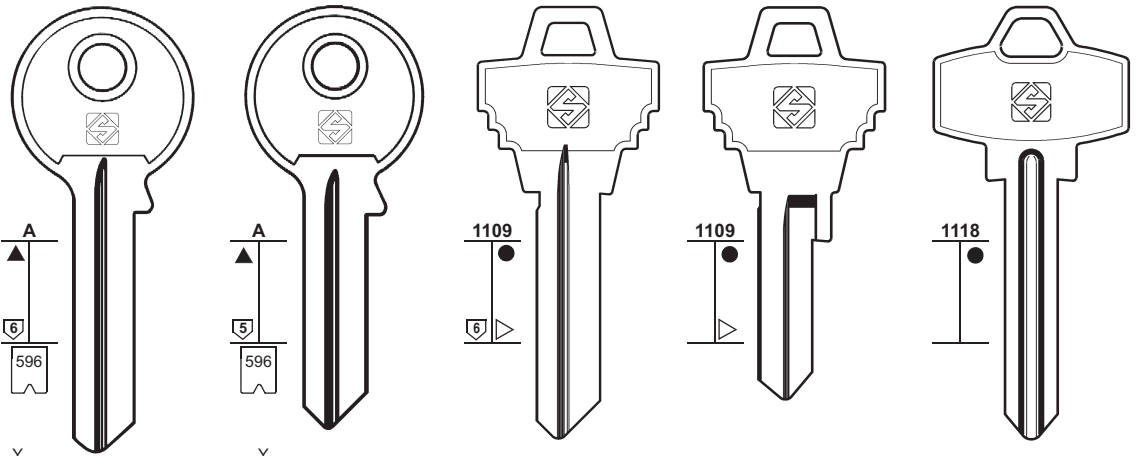

GO2R



GO1R



GO4R



GO3



GO5

Y.....
1-2-3-4-5-6-7

Y.....
1-2-3-4-5-6-7

PER: FOR:	GOAL	GODREJ	GOLD
	<p>1378 S547 S731 S884 GO6</p> <p>1378 S548 S877 GO7</p>	<p>GJ3</p>	<p>62 GOD4R</p>

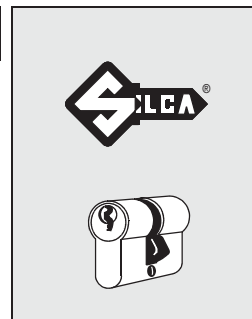

89

- PER / FOR
- GOAL (J)
+ GSS (90)
 - GODREJ (IND)
 - GOLD (BRA)
 - GOLD-DOOR (RC)
GLOBE
+ GLOBE (87-88)
 - GOLLOT (F)
RONIS (146)
 - GOTTA (D)
FTH (82)
 - GÖTZ (D)
KFV (105)
 - GP (I)
 - GPR (F)
FTH (82)
 - G.R. (F)
(GUERVILLE-RIQUIER)
DEBEURAIN
MONDIAL
SE

PER: FOR:	GOLD DOOR	GP	G.R. (GUERVILLE RIQUIER)
	<p>56 GL20 GLOBE</p>	<p>1129 GPI1</p>	<p>717 RIQ10R</p>

PER: FOR:	G.R. (GUERVILLE RIQUIER)	
	<p>53 302 RIQ3 RIQ2 R 1234567890 F 1234567890 G 1234567890 RIQ6S Y 1234567890 MONDIAL</p>	<p>54 302 RIQ8 RIQ8R RIQ1 RIQ1R Z 1234567890 T 1234567890 XT 1234567890 Y 1234567890 DEBEURAIN - SE</p>



90

PER / FOR

G.R. (F)
(GUERVILLE-RIQUIER)
ABUS
BRICARD
PERRIER

GRAF (D)
KfV (105)

GRAYHILL (USA)
ILLINOIS (96)

GRIFO (RC)

GRUNDMANN (A)
GEGE (84)

GS (GR)
STAR (161)

GSA (I)
CAS-CISMA (40)

GSS (J)
GOAL

GTV (D)
JOWIL
TIEFENTHAL
+ CISA (48)
+ EMR (69)
+ JOWIL (100)

GUARD (HK) (CZ)
ABUS
EKLA
ROYAL
+ ABUS (8)
+ FAB (74)

PER:
FOR:

G.R. (GUERVILLE RIQUIER)

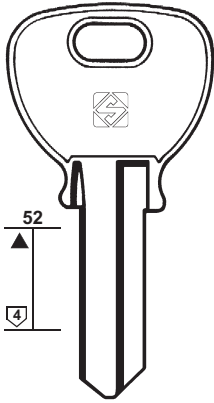

RIQ5



RIQ5R

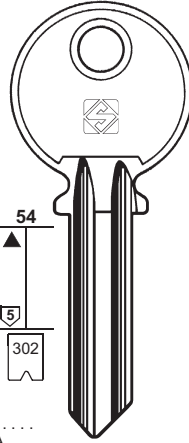

RIQ4



RIQ4R

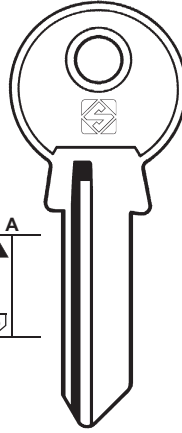

RIQ9



RIQ9R

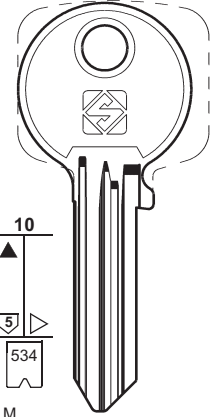

RIQ11



RIQ11R

.....
A.....
1-2-3-4-5-6-7-8-9-0

M.....
P.....
S.....
1-2-3-4-5-6-7-8-9-A-B-C-D-E-H-K-L

PERRIER

BRICARD - PERRIER

ABUS - BRICARD

PER:
FOR:

GRIFO

GSS

GTV

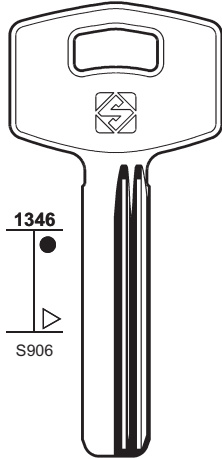

GF1

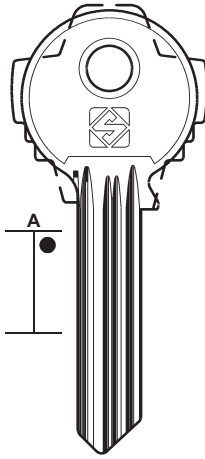

GSS1

GOAL

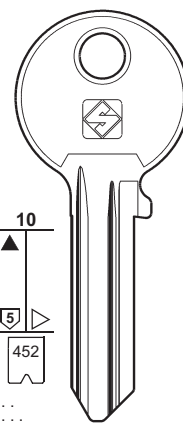

.....
0-1-2-3-4-5-6-7-8-9



GV1



GV2



GV3



GV4R



GV5R



GV6R

TIEFENTHAL

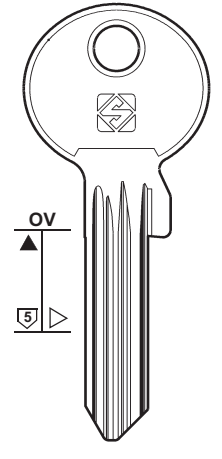

GV7

JOWIL - TIEFENTHAL

PER:
FOR:

GUARD

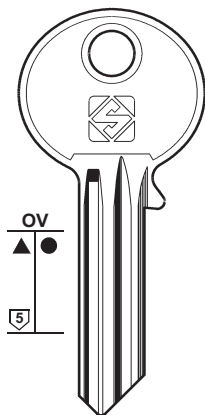

GD8



GD8R

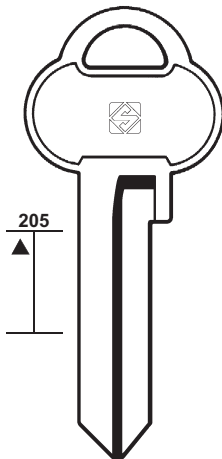

GD5

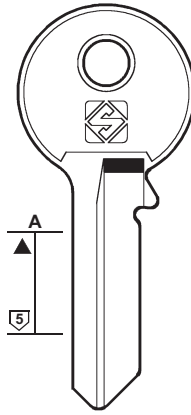

GD2

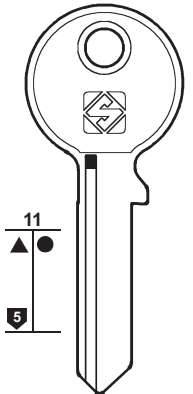

GD4



ABUS - EKLA - ROYAL

PER:
FOR:

GUARD

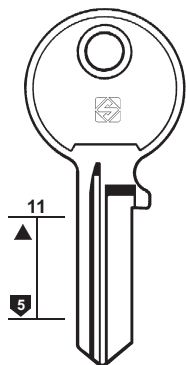

GD6R

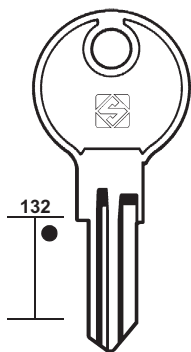

GD3

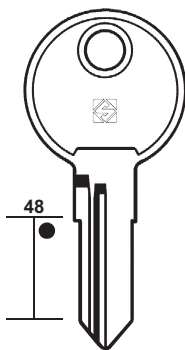

GD7R

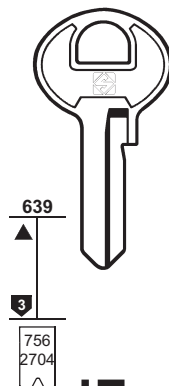

AB23

... 1-24
... 65/251-2-3-4-5

AB23R



GD1

GD1R



91

PER / FOR

GUARD (HK) (CZ)
ABUS

+ ABUS (8)
+ FAB (74)

GUARDIAN (I)

+ CAS-CISMA (40)
+ F.F. (78)

GUARUP (BR)

GUSHENG (CHN)

GUIDOTTI (F)

+ RONIS (146)

GUITTEL (F)

+ ABUS (8)

GÜTLER (D)

+ SIMECA (155)

HÄFELE (D)

+ BKS (30)
+ CES (41-42)
+ DOM (61-62)
+ HUWIL (94)
+ KIFERM (106)
+ LAS (110)

HAGA (BR)

HAIDE (RC)

+ YETI (198-199)

HALLE (D)

+ BAB (26)

HAMPTON (GB)

+ MASTER (119)

HANNO (D)

+ CES (41-42)

HARLOC (USA)

+ EAGLE (67)

PER:
FOR: **GUARUP**

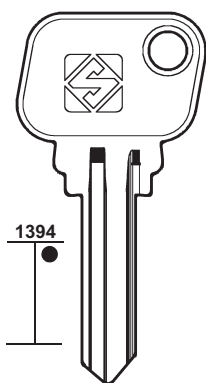

GUR1

GUSHENG

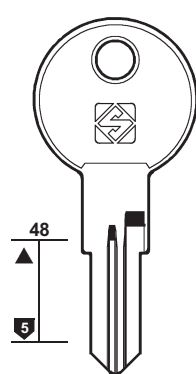

GUS1

HÄFELE

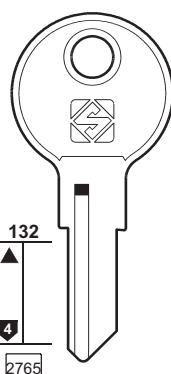

HF1R

TA ... 100-999

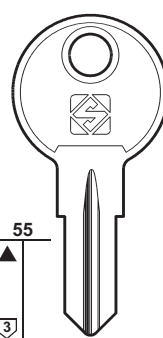

HF73R

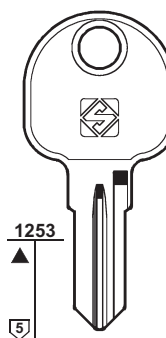

HF74 HF74R

... 1-200

PER:
FOR: **HÄFELE**

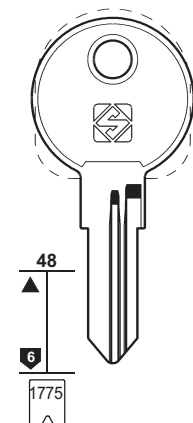

HF75

HF75R
... 1-3936

HAGA

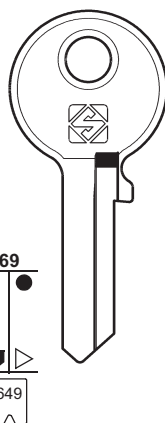

HAG1

HAG1R

..... 1-2-3-4-5-6

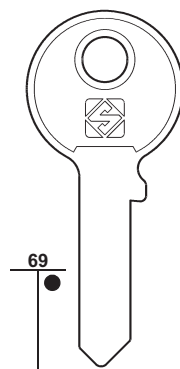

HAG6R

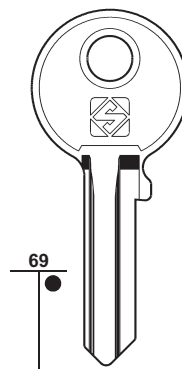

HAG7

HAG7R

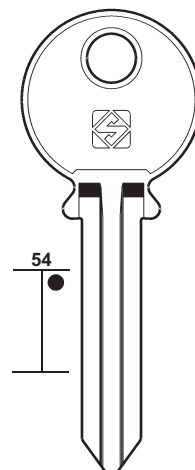

HAG5



92

PER / FOR

HARP (HK)

HASLER (D)
+ SEA (152)

HASMAN (IND)

HB (I)
 LEGALLAIS (111)

HBC (D)
 MELSMETALL (122)

HDL-PACRI (BR)

HECTOR (E)

HEGO (D)
 CORBIN (53)

HEKNA (D)
METALCASTELLI
RAUCO
REGENT
+ DOM (61)
+ HR (93)

HEL (E)

HEMA (RC)
 VACHETTE (181)

HEMY (F)
 YETI (198-199)

PER: FOR:	HARP	HASLER	HASMAN	HDL-PACRI
	 41 4	 582	 87	 A
	 HP1R	 HS1R	 HA1R	 HDL3 HDL3R

PER: FOR:	HDL-PACRI	HECTOR	HEKNA
	 1430 4	 1308	 30 5 142 237 P98 5 237
	 HDL1R	 HCT1R	 HN1 HN2 1001-1425 C..... 1251-1700 HN4 HN5R HN1P 1001-1425
			 METALCASTELLI - RAUCO REGENT

PER: FOR:	HEKNA	HEL
	 55 5 755 401	 A 7 54 6 A 5
	 HN3 HN3R HN6 HN7	 HE3R HE2 HE2R HE1 HE1R
	 1-2-3-4 1501-1540	

PER: FOR:	HENDERSON	HILLO	HK	HOK	HOPPE
	167 4 272	11 5	49 4	1434 5	1261 5 1643
	 HEN1 R... 008-254	 HL1R mm 40	 H1 H1R mm 20	 HOK1R 	 HPP1 HPP1R ... 1001-3187
	REAGENT	GLOBE - HERO			BURG - KIND - MAUSER

PER: FOR:	HORSE	HR	HTV
	438 5	521 5	132 5 1809
	 HO1R HO2R	 HR1 E 	 HT1 HT1R HT2 07 04
		HEKNA - HERO - OJMAR	VAUGHN SHAW - VAUGHN - YALE

PER: FOR:	HUDSON	HUGIN	HUGO
	132 5 142	178 178	616 1219 11
	 HD1R HD1 HD2 HD2R A... 201-1050 C... 500-699 H... 601-1100 HM... 201-1050 	 HG1 HG2 A 	 HG3 HGO1R P

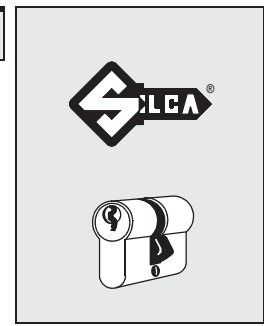

93

- PER / FOR**
- HENDERSON (GB)**
REGENT
+ UNION (176)
 - HERMES (RC)**
 YETI (198-199)
 - HERO (D)**
 HILLO (93)
 HR (93)
 - HESTE (D)**
 CORBIN (53)
 - HILLO (RC)**
GLOBE
HERO
 - HK (D)**
 - HMP (RC)**
 ALPHA (15)
 - HOBBY (GB)**
 EURO LOCKS (71)
 - HÖHRMANN (D)**
 BKS (30)
 CES (42)
 DOM (62)
 GEGE (84)
 - HOK (TR)**
 - HOPPE (D)**
BURG
KIND
MAUSER
+ BURG (38)
 - HOOPLY (PRC)**
 WANJIN (188)
 - HORSE (RC)**
 - HR (D)**
HEKNA
HERO
OJMAR
 - H.R.S. (F)**
 TH (166)
 - HSA (D)**
 KJV (105)
 - HTV (GB)**
SHAW
VAUGHN
YALE
 - HUDSON (USA)**
+ FORT (81)
+ SEGAL (153)
+ YALE (194)
 - HUGIN (S)**
 - HUGO (D)**



94

PER / FOR

HUNIT (I)

+ FTH (82)

HUTRA (D)

+ SCHLECHTENDAHL (152)

HUWIL (D)

CEKA
CHRIST
HÄFELE
L.M.C.
MAUSER
SCHÄRF
STEELCASE
STRAFOR
WILLACH
WÜRTH
+ BOMORO (33)
+ DOM (61)

IALEX (P)

IBFM (I)

+ L & F (116)

ICA (E)

ICSA (I)

ORLANDO
REMO
ZANI
+ LINCE (112)

IDEAL (RC)

+ DOM (61)

IDEAL SECURITY (USA)

+ WEISER (189)

IDRO STOP (I)

CEV

PER: HUNIT
FOR:

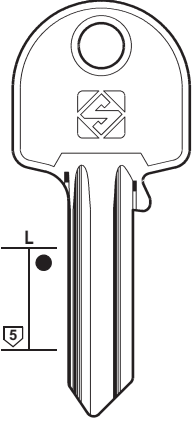

HUT1

HUWIL

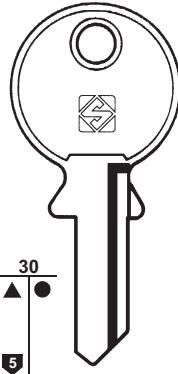

HW1

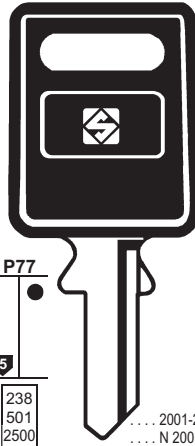

HW1P

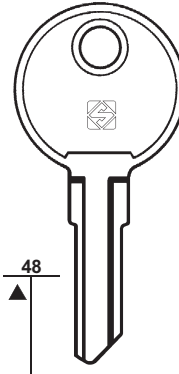

HW2
R



HW3
V

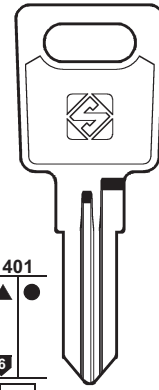

HW4

HW4R

... 000-051
... 0001-1915
... 0A-9Z
IG ... 14101-16020
... 22001-23920
DE ... 25500-27419
... A 3001-4000
W ... 3001-4000
... 3001-4001
... 3010-3999
... 3202-4004
... A 5001-5050
A ... 5001-5050
... 5001-6169
... 7000-8001
PL ... 7420-8419
RA ... 7480-8479
... 7526-7726
FH ... 7526-7726
... 8001-8321
... 8001-9541
... LH 8701-9700
UO ... 9000-9999

CHRIST - HÄFELE - L.M.C.
WILLACH - WÜRTH

HÄFELE
STRAFOR - STEELCASE

PER: HUWIL
FOR:

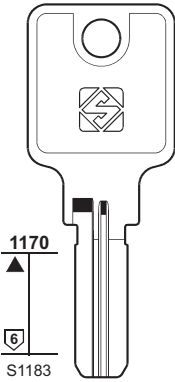

HW15R

CEKA - HÄFELE
MAUSER - SCHÄRF

IALEX

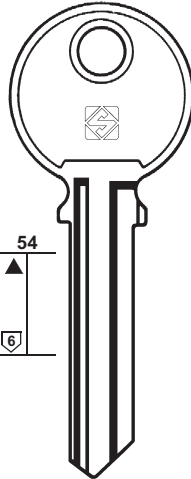

IX1 IX1R

IBFM

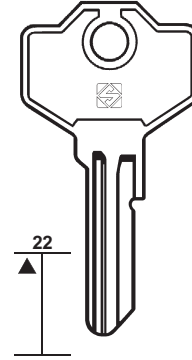

IBF1 IBF1R

ICA

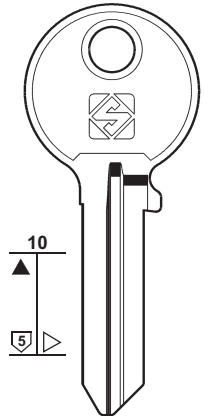

ICA1R

PER: ICSA
FOR:

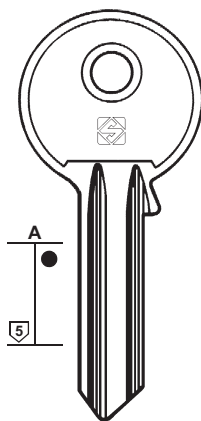

ICS1 ICS1R

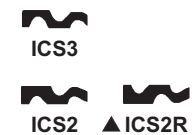
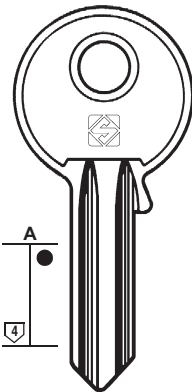

ICS3 ICS2 ▲ICS2R

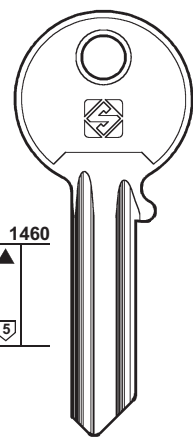

ICS5

ORLANDO
REMO - ZANI

IDRO-STOP

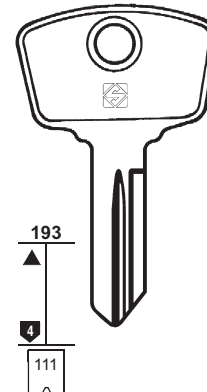



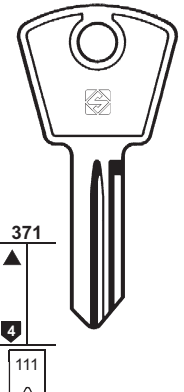







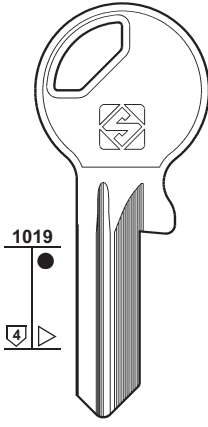

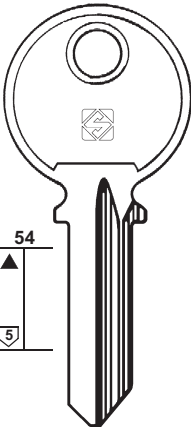

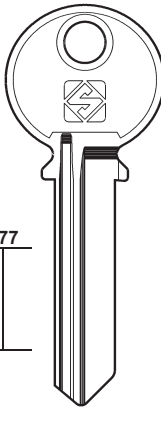

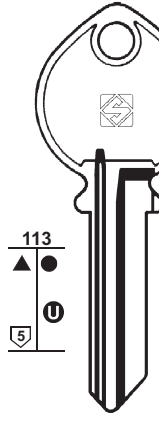

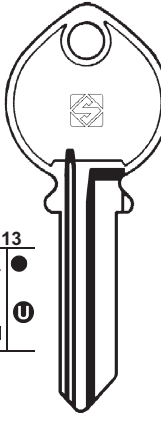
ISP2
.. 1-78

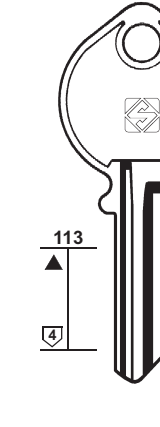

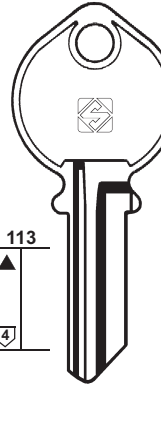
ISP4
.. 1-78

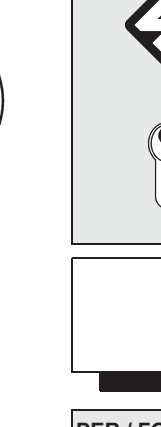









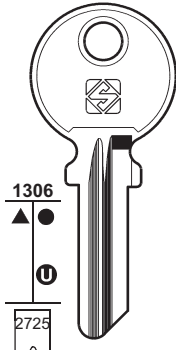

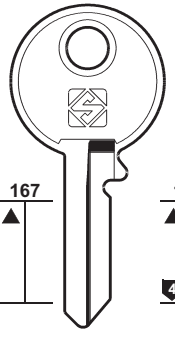

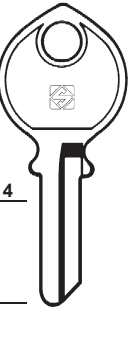

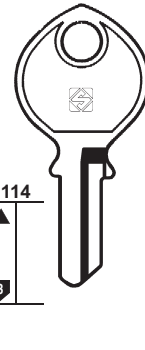
CEV

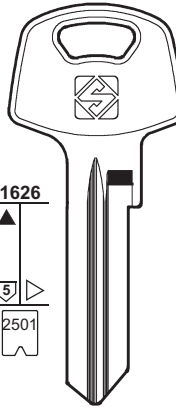
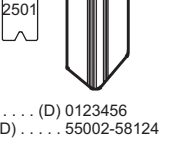
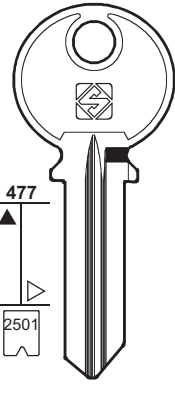
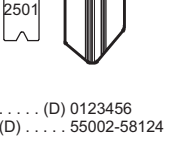









PER: FOR:	IES	IFAM					
 1019  IES1R	 54  IF1	 477  IF7	 113  IF7R	 113  IF3	 113  IF3R	 113  IF2	 113  IF2R
				 mm 45-50-55	 mm 35-40 RIPA		



95











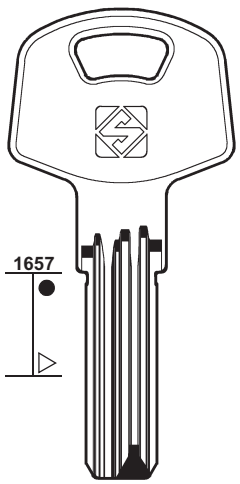

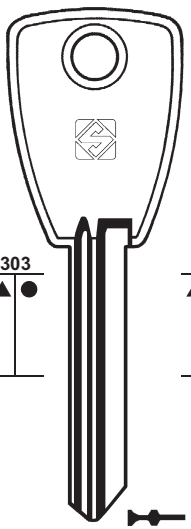
PER: FOR:	IFAM					
 1306  IF6 4001-4240	 167  IF8	 114  IF4	 114  IF5	 1626  (D) 0123456 (D) 55002-58124 IF12R	 477  (D) 0123456 (D) 55002-58124 IF13R	
	 IF8R	 IF4R	 IF5R			
	 JOMA	 JOMA	 BATU - RIPA - TEM mm 25	 JOMA - TEM mm 20		

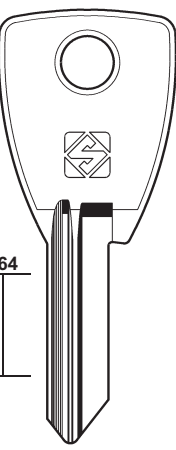
- PER / FOR**
- IES (I)**
- IFAM (E)**
 BATU
 JOMA
 RIPA
 TEM
 +  BUGA (36)
 +  CHICAGO (46)
 +  CISA (50-51)
 +  FTH (82-83)
 +  GLOBE (88)
 +  ISEO (97)

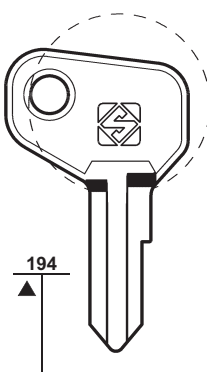
- IGS (F)**
- IJ (F)**
 JTF
 +  JTF (100)
 +  MERONI (124)
 +  STAR (161)

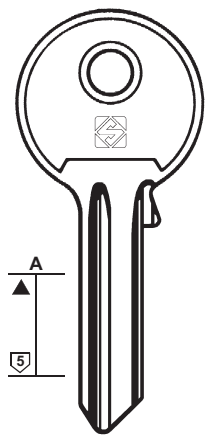
- IJN (F)**
 KIFERM (106)

ILARGI (E)

PER: FOR:	IFAM	IGS		IJ	ILARGI
 1657  IF14	 303  IS2	 264  IS1	 194  IJ1	 A  IL1R	 5  IL1
			 JTF		



96

PER / FOR

ILCO (USA)
BARGMAN

ILLINOIS (USA)
DUO
GRAYHILL
LAGRANGE
OTIS
SEEBURG
+ CHICAGO (45)

ILS (I)
+ FASEM (77)

IMAB (BR)

IMBAC (F)
PREFER (143)

IMP (D)
ABUS (8)

IMSI (I)
PERINO (140)

INDAUX (E)
FAC (75)

INDESIT (I)
ELSI
MIT
RECA

INGERSOLL (GB)

PER:
FOR:

ILCO

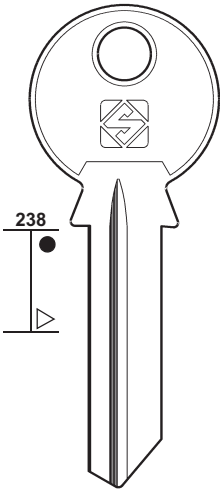

ILC13R

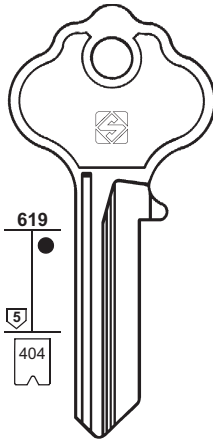

ILC2

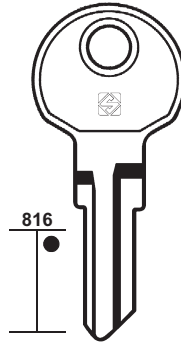

ILC6

BARGMAN

ILLINOIS

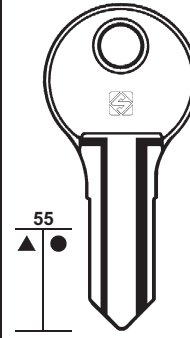

IN1



NUOVO PIGNONE
GRAYHILL - LAGRANGE
OTIS - SEEBURG

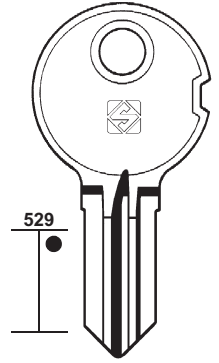

IN2
H
IN3
J



PER:
FOR: ILLINOIS

ILS

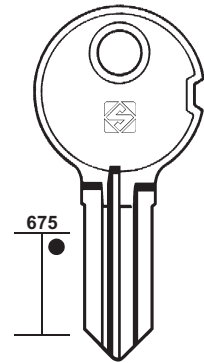

IN5



DUO

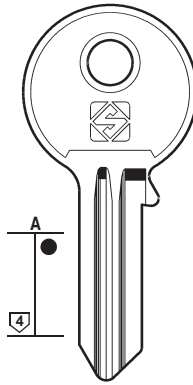

ILS1



IMAB

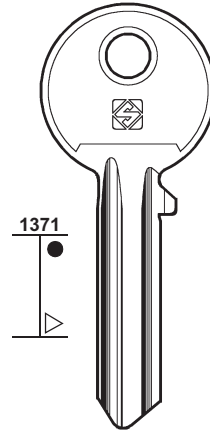

IAB7

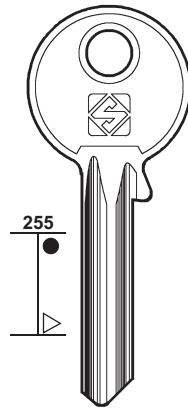

IAB8

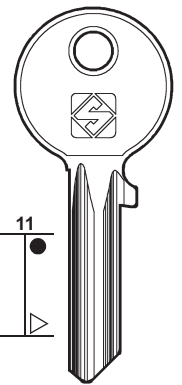

IAB9



PER:
FOR:

INDESIT

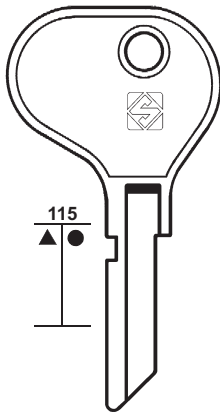

ID1
REG

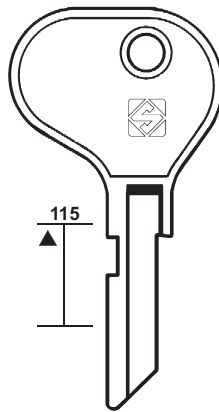

ID2
X

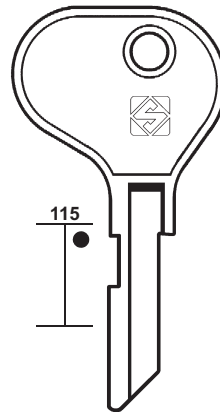

ID3
MGR



INGERSOLL

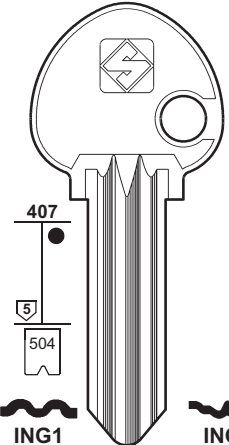

ING1
A 1-2-3-4







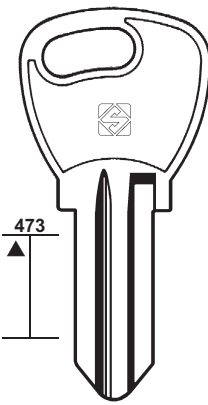
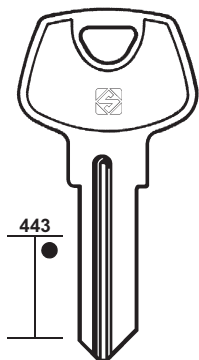

ING2
W

ING5
S 1-2-3-4

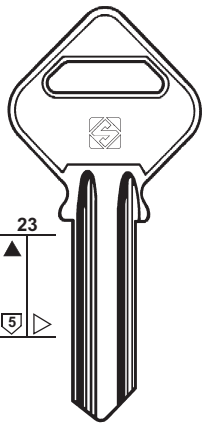
ING6
N

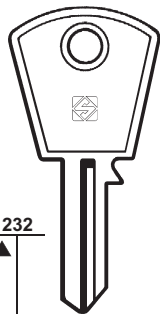





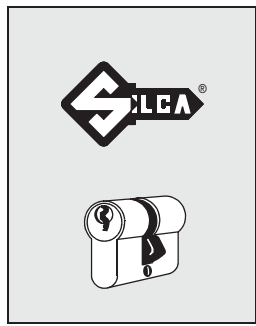





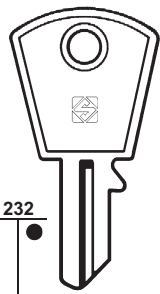



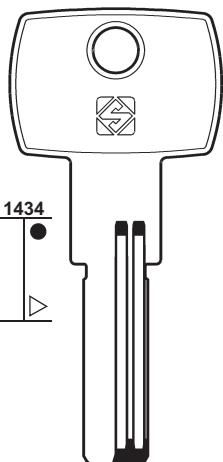

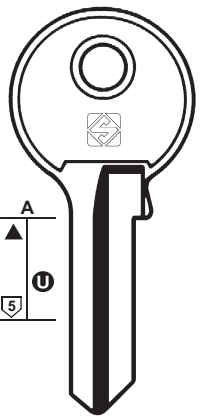

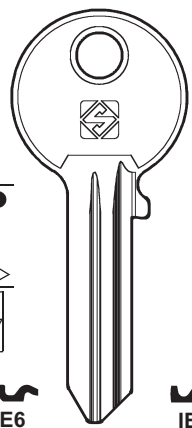

ELSI - MIT - RECA

PER: FOR:	INGERSOLL	INSA	INT
	 473  443  ING3  ING4R	 23  INS1	 232  IT1  IT1R 











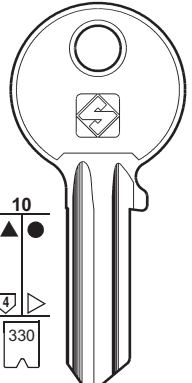





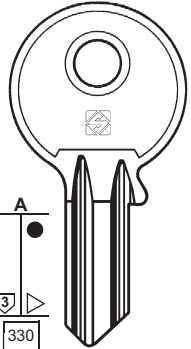



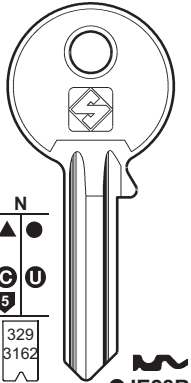



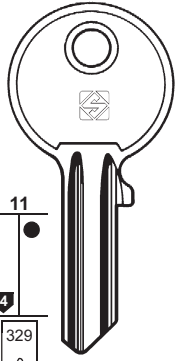

97

PER / FOR
INGERSOLL (GB)
INLOC (F)
 BRICARD (35)
INSA (I)
INT (I)

PER: FOR:	INT	I.R.	ISABEL FAINER'S	ISEO
	 232  IT2  IT2R 	 1434  IR1 	 A  IB1 	 10  330 2567  IE6 IFAM - STAR 012345678 LCE 1-17513 Y 1-2000 YO 1-2000  IE6R 012345678 KFC 1-28800 1-6516  IE10  IE2R 1-2000 0-1-2-3-4-5-6-7-8  IE9 1-2000 ME 1-210 CAM  IE31  IE27R F3 0-1-2-3-4-5-6-7-8-9  IE13  IE12  IE10

I.R. (F)
 + DOM (63)
 + W.M.S. (192)
**ISABEL
FAINER'S (P)**
ISEO (I)
 CAM
 IFAM
 STAR
 + VACHETTE (180)

PER: FOR:	ISEO				
	 10  330 0-1-2-3-4-5-6-7-8  IE7  IE7R  IE224  IE225	 A  330 ... 0-1-2-3-4-5-6-7-8  IE8  IE8R	 N    329 3162  IE3  IE3R 1-2-3-4-5-6  IE1  IE1R 1-2-3-4-5-6	 11  329 1-2-3-4-5  IE4  IE4R	 74  329 ... 1-2-3-4-5  IE5



98

PER / FOR

ISEO (I)
ATRA
CITY
VACHETTE
+ VACHETTE (180)

ISSERSTEDT (D)
CORBIN (53)

ITALBLOCK (I)
EUREKA (70)

ITO (TR)
CISA (48)
FTH (83)

ITOKI (J)

IULIA MAS FED (I)
FASEM (77)

PER:
FOR:

ISEO

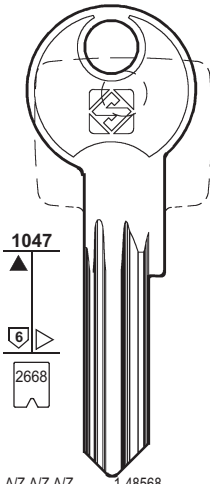

1047
6
2668

A/Z A/Z A/Z 1-48568

F6
IE29

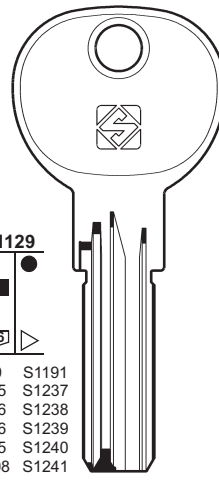

1129
5+6+6

S99 S1191
S725 S1237
S726 S1238
S916 S1239
S965 S1240
S1108 S1241

EDL
CFA 1-27065
EDL 1-350589
ECA 1-050000
ECA 100001-150000
EDA 1-350589
EDY 1-350612
EGE 1-027508
EGE 100001-127508
EGE 200001-227508

HNH
IE14
R11

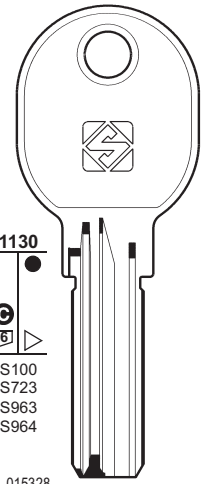

1130
5+6+6

S100
S723
S963
S964

ABL 1-015328
ACY 1-015328
AGL 1-015328
ABF 1-015694

HNH
IE15
R6



CITY - VACHETTE

PER:
FOR:

ISEO

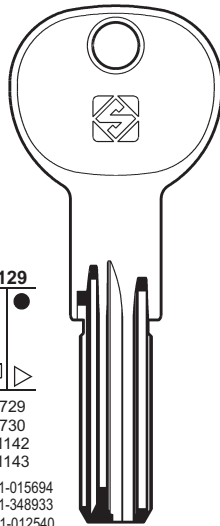

1129
5+6+6
S729
S730
S1142
S1143

AAC 1-015694
DAA 1-348933
AMB 1-012540
AMB 100001-112540

HNH
IE26



ATRA - CITY

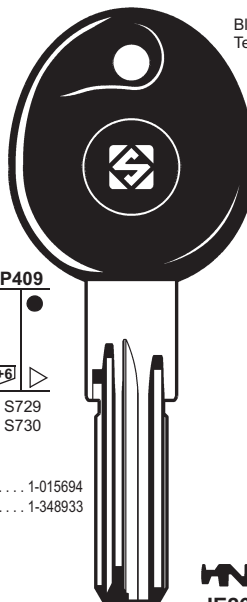

P409
5+6+6
S729
S730

AAC 1-015694
DAA 1-348933

HNH
IE26P

Blue head
Testa blu

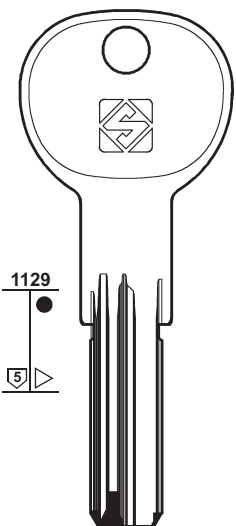

1129
5

HNH
IE30



PER:
FOR:

ITO

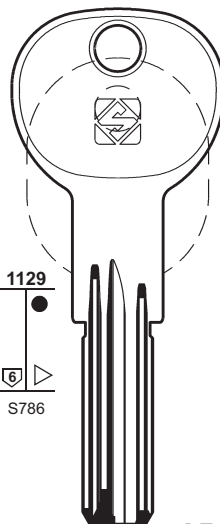

1129
6
S786

HNH
IO1



ITOKI

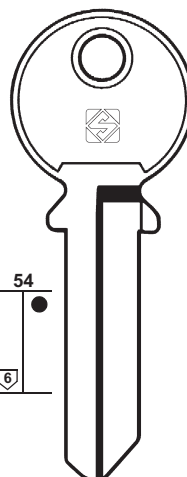

54
6

ITO1R ITO2 ▲

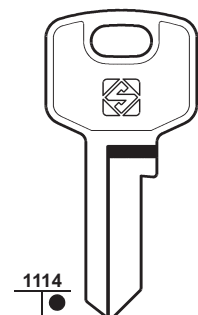

1114

ITO3 ITO3R

PER: FOR:	IWATA	JÄBA	JAPAN	
			 ● JPN2	

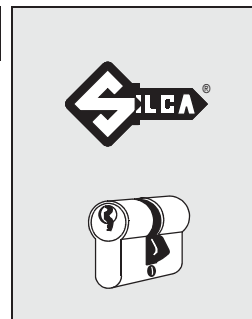

99

PER / FOR
IWATA (J)
JÄBA (DK)
JAPAN (J)
JARDI (E)
JD (J) 👁️ ALPHA (15)
JEHU (RC)
JET (D) 👁️ ABUS (7)
JIP (F) 👁️ PREFER (142) 👁️ RONIS (146-147)
JIS (E) SEMEL
JL (F) 👁️ FTH (81)
JMR (E) 👁️ EZCURRA (73)
JNF (IL) 👁️ EVERGOOD (71)
JOLY (F) 👁️ GABON (84)
JOMA (E) 👁️ IFAM (95)
JORE (D) 👁️ WILKA (191)
JOSTA (D) 👁️ CES (41-42)

PER: FOR:	JARDI	JEHU	JIS

PER: FOR:	JIS			

SEMEL



100

PER / FOR

JOWIL (D)

- ESZ
- FUHR
- GTV
- JÜNGST
- MERCUR
- OSKO
- PANTHER
- TIEFENTHAL
- TRITON
- VOKO
- WEPA

+ EMR (69)

JPM (F)

- + ABUS (6-7)
- + CISA (49)
- + KESO (104-105)
- + SIMECA (155)

JTF (F)

- IJ
- + IJ (95)
- + MERONI (124)

JU (D)

- + KIFERM (106)
- + VACHETTE (181)

PER:
FOR:

JOWIL

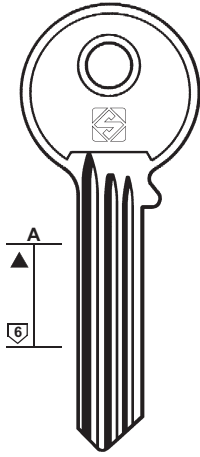

JOW8

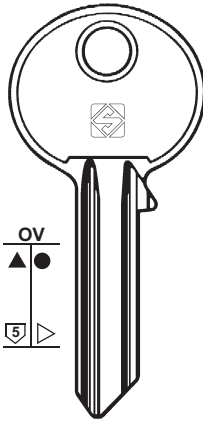

JOW1 JOW1R

ESZ - FUHR - GTV
JÜNGST - MERCUR
OSKO - PANTHER
TIEFENTHAL
TRITON - VOKO - WEPA

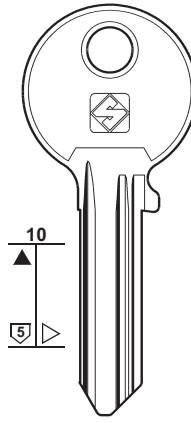

JOW2
JOW5
JOW6
JOW7
JOW9
JOW10

JOW11

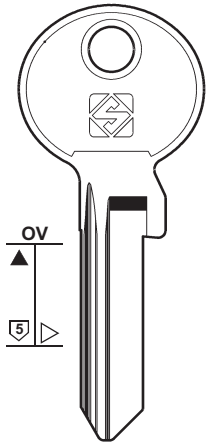

JOW12X JOW12RX

PER:
FOR:

JOWIL

JPM

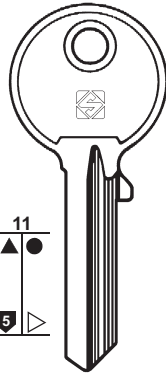

JOW3R

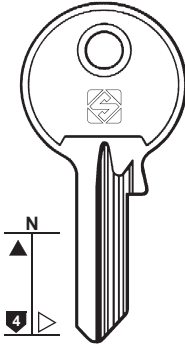

JOW4R

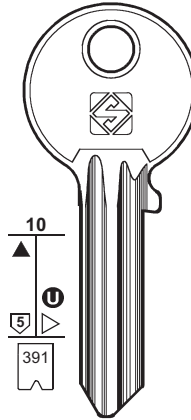

JM3 JM3R
A
X
1-2-3-4-5-6-7

JM2 JM2R

JM1 F3

- AY.....
- BA.....
- BB.....
- BC.....
- BD.....
- BD.....
- BL.....
- BM.....
- BN.....
- BP.....
- BQ.....
- BR.....
- BS.....
- BT.....
- BU.....
- BY.....
- F3C.....
- SA.....
- SB.....
- 1-6032

JM1R F3 F3D 1-6032

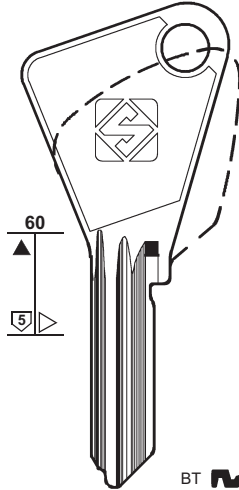

BT JM6

BK JM7

PER:
FOR:

JTF

JU

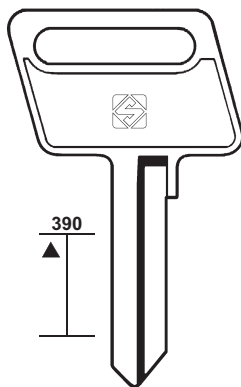

JT1 JA

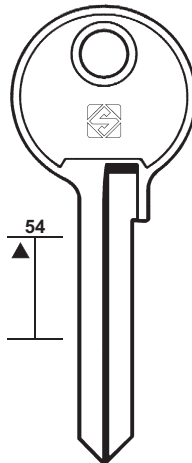

JT2R

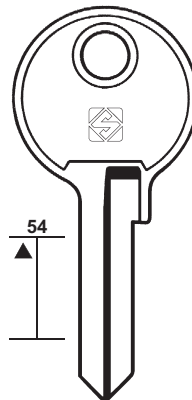

JT3R

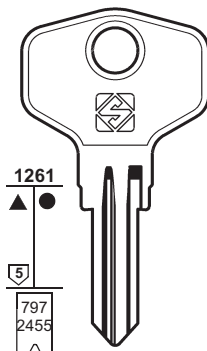

JU11 D
..... (A) 1-2-3
B ... (D) 376-500+(507-508)

JU11R A
..... (D) 1-2-3
B ... (A) 001-125+(501-502)

JU12 C
..... (B) 1-2-3
B ... (C) 251-375+(505-506)

JU13R B
..... (B) 126-250+(503-504)



PER: **JUNGHEINRICH**
FOR:

JUNIE

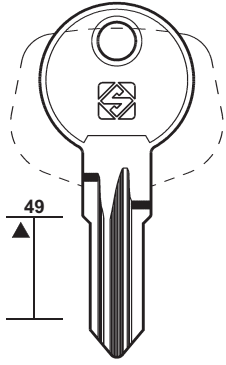

JR1R

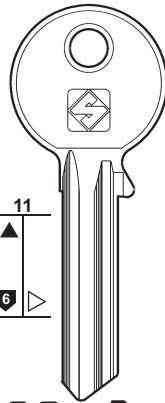

JU3 JU4

JU6 JU8

JU14

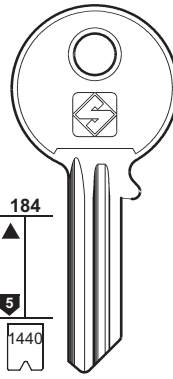

JU2 JU2R

JU7 JU10

0-1-2-3-4-5-6-7



PEROHAUS - VS

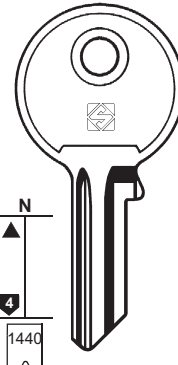

JU1 JU1R

... 0-1-2-3-4-5-6-7
NN ... 2001-2998



PEROHAUS - VS



101

PER / FOR

JUNGHEINRICH (D)

JUNGHWA (J)

JÜNGST (D)

JOWIL (100)

JUNIE (D)

PEROHAUS VS

JUNKUNC (USA)

ALSO AMERICAN FEDERAL LION

JUWEL (I)

+ FASEM (77)

PER: **JUNIE**
FOR:

JUNGHWA

JUNKUNC

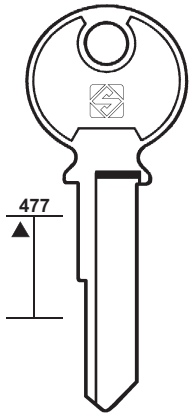

JU5

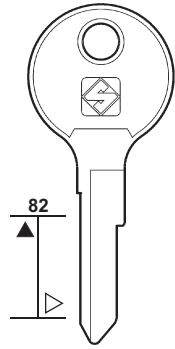

JU9

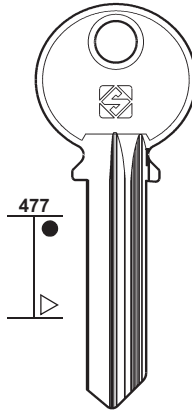

JN1R

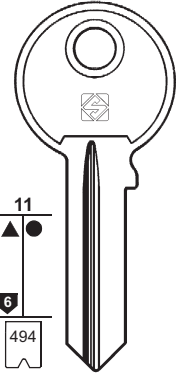

JC2R

... 80000-88999



ALSO - AMERICAN - FEDERAL - LION

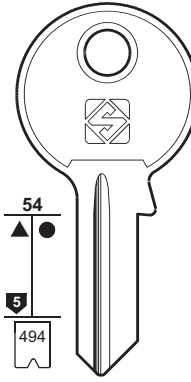

JC1

... 1-2-3-4-5-6-7-8



PER: **JUWEL**
FOR:

JUWEL

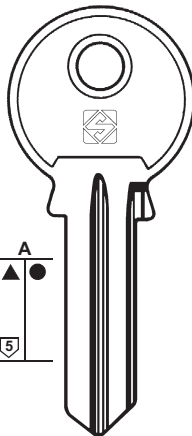

JW4R 2

JW5 3

JW6 5

JW7R 10

JW8 51

JW9 52

JW12

JW13 16

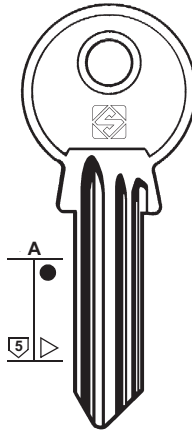

JW1R

JW1

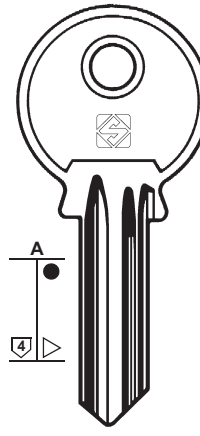

JW2R

JW2



102

PER / FOR

JUWEL (I)
+ FASEM (77)

JVAL (P)
FEB
P.C.
SAVIO
+ P.C.
(CORTELLEZI) (140)

KABA (CH)
BORKEY
LÄSBOLAGET
PICARD

PER:
FOR:

JUWEL

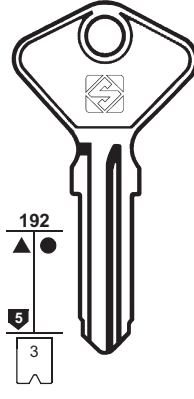
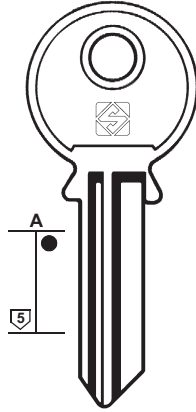
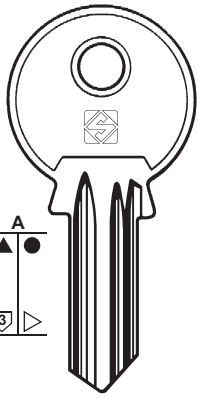

JVAL

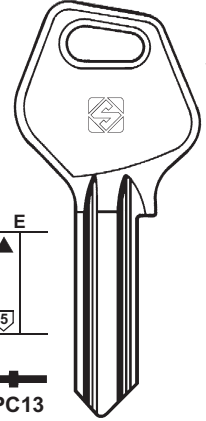

FEB - P.C. - SAVIO

PER:
FOR:

JVAL

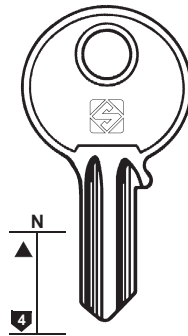
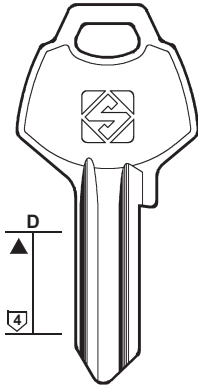
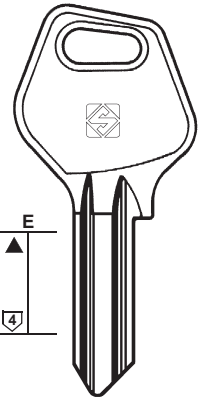

FEB - P.C.

FEB

KABA

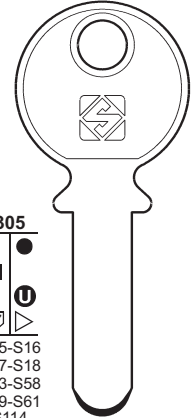

S15-S16
S17-S18
S53-S58
S59-S61
S114

PH....
0001-9000
... 1-200



LÄSBOLAGET

PER:
FOR:

KABA

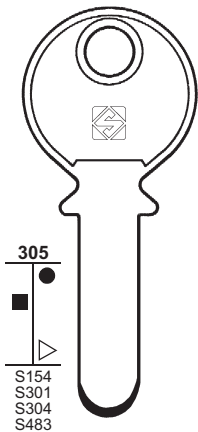

KA2
20

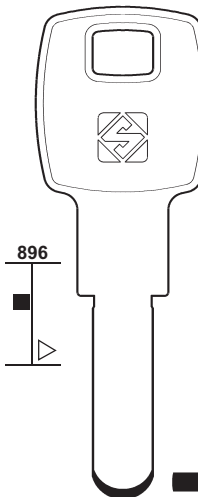

KA7



PICARD

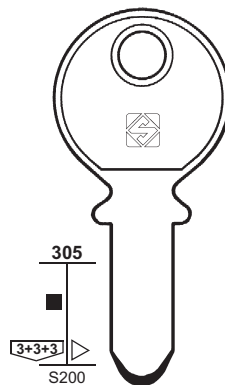

KA6



BÖRKEY

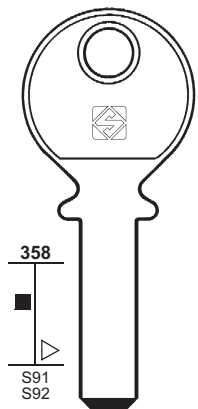

KA3
MINI KABA



PER:
FOR:

KABA



103

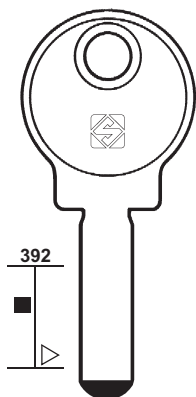

KA4

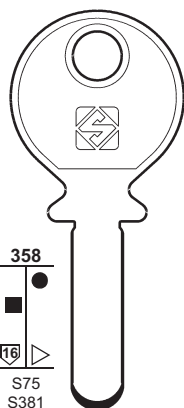

KA5

GEMINI



DORSET

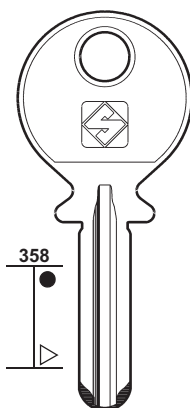

KA9

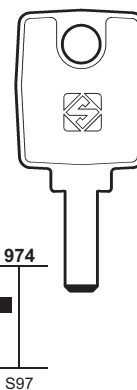

KA8

MICRO KABA



PER / FOR

KABA (CH)
DORSET

KAKEN (ROK)

KALE (TR)

- + ABUS (7)
- + BUVA (39)
- + TESA (166)

PER:
FOR:

KAKEN

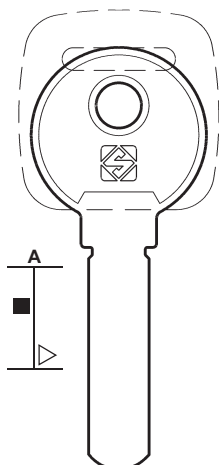

KAK1



KALE

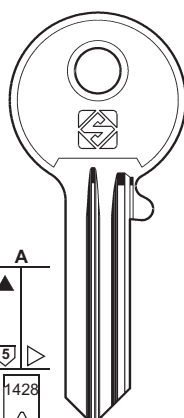

KLE3R

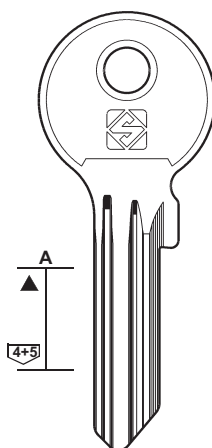

KLE3X

KLE3RX

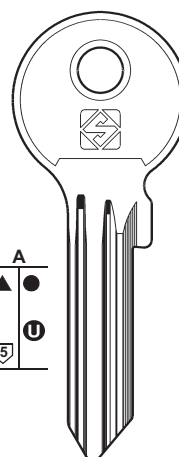

KLE6X ▲

KLE6RX ▲

..... 1-2-3-4-5-6-7-8-9

KLE5X

KLE5RX

KLE7X

KLE7RX ⊖

PER:
FOR:

KALE

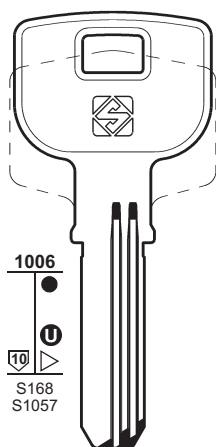

KLE1

KLE4

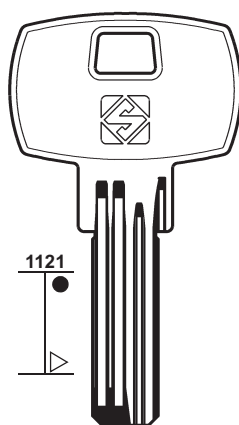

KLE2R

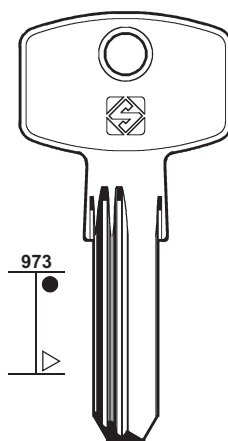

KLE8R

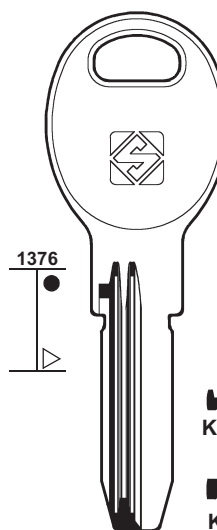

KLE10R

KLE9R





104

PER / FOR

KALUGA (RUS)

KARDEX (F)

👁️ CES (41-42)

👁️ RONIS (147)

👁️ VINCO (186)

KARO (E)

👁️ FTH (82)

KASPIJSK (RUS)

KATE (D)

👁️ SIMECA (155)

KAWE (D)

👁️ CORBIN (53)

👁️ TESA (165)

👁️ WEISER (189)

KAZAN (RUS)

KEIL (USA)

KESO (CH)

JPM

PER:
FOR:

KALUGA

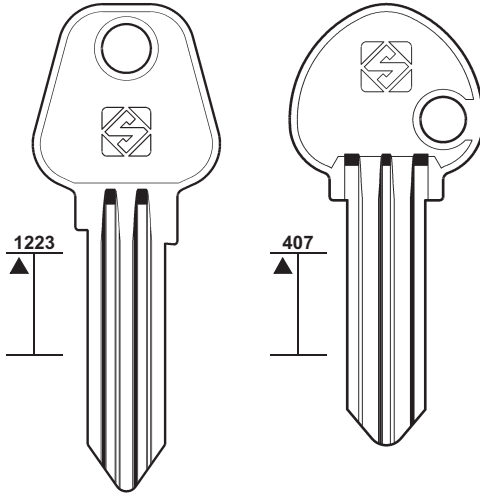

KL G1 R

KL G2 R

RUS 2

KASPIJSK

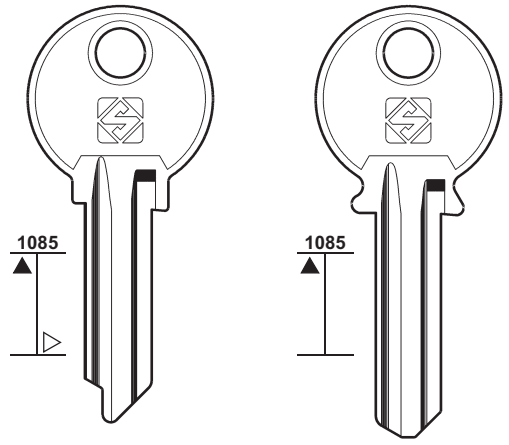

KAP 1

KAP 1 R

RUS 1

RUS 1 R

PER:
FOR:

KAZAN

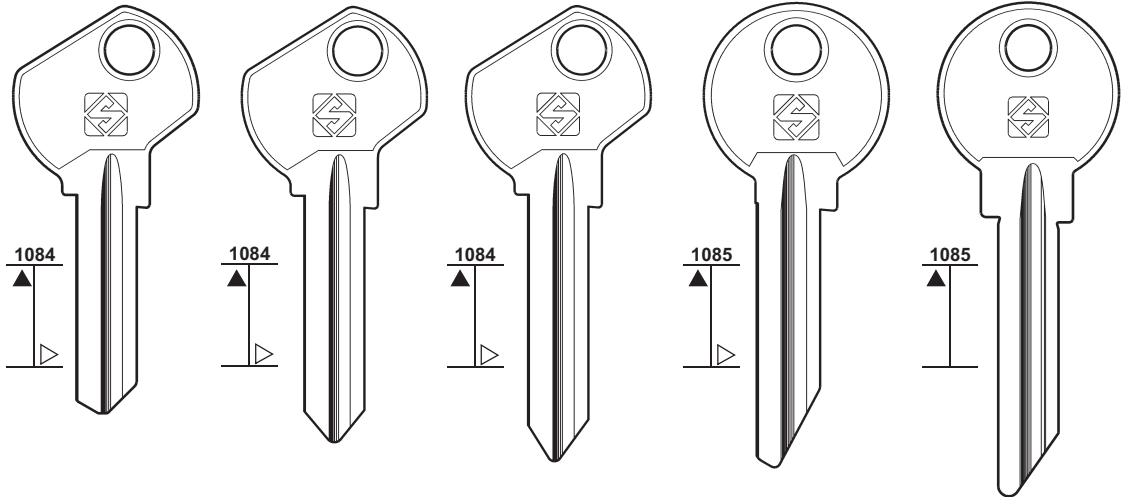

KAZ 1 R

KAZ 4 R

KAZ 5 R

KAZ 2

KAZ 2 R

KAZ 8 R

PER:
FOR:

KAZAN

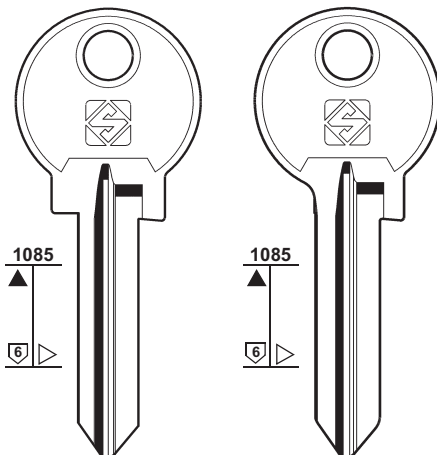

KAZ 3 R

KAZ 7 R

KEIL

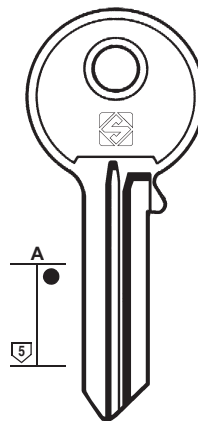

KEI 1 R

KESO

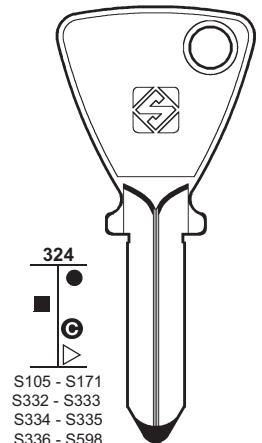

S105 - S171
S332 - S333
S334 - S335
S336 - S598
S599 - S600
S601 - S678
S259 - S807

KE 1



JPM

PER: **KESO**
FOR:

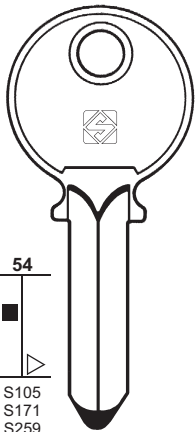

54

- S105
- S171
- S259
- S332
- S333
- S334
- S335
- S336
- S598
- S599
- S600
- S601

KE2



JPM

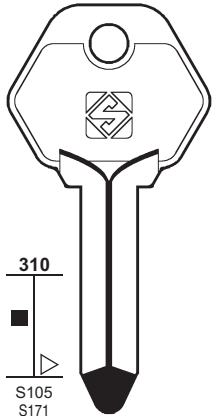

310

- S105
- S171
- S259
- S332
- S333
- S334
- S335
- S336
- S598
- S599
- S600
- S601

KE4



SARGENT

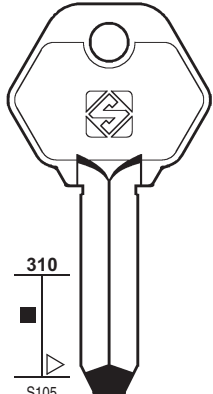

310

- S105

LP11



LIPS

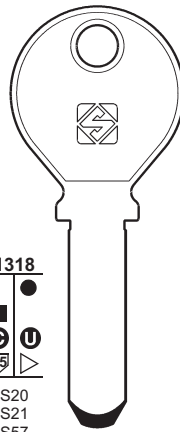

1318

- S20
- S21
- S57
- S267
- S273
- S277
- S359
- S1298

KE3



ALA

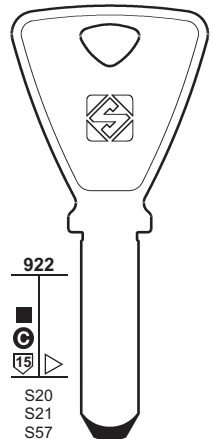

922

- S20
- S21
- S57
- S267
- S273
- S277
- S359
- S663
- S1298

KE9



JPM



105

PER: **KESO** **KEYA** **KFV**
FOR:

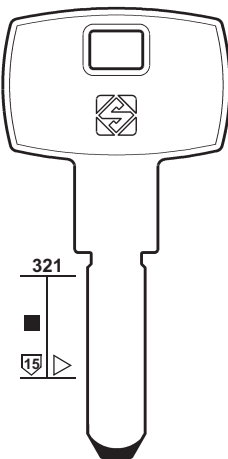

321

KE11



JPM

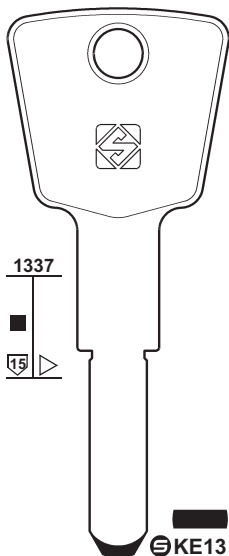

1337

KE13



FIAM

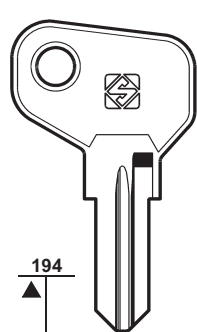

194

KEY1

KEY1R

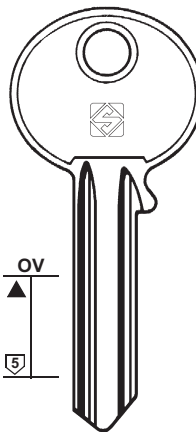

OV

KF1

- KFA
- KFB
- KFC
- KFD
- KFE
- KFF
- KFG
- KFH
- KFS
- KFR
- KFJ
- KFK
- KFL
- KFM
- KFN
- KFO
- KFI
- KFU
- KFX
- KFW

COMBA - FCV - FLIETHER
GIESCHE - GÖTZ - GRAF - HSA
NICO - SCHÜCO - SEN

PER: **KHARKOV**
FOR:

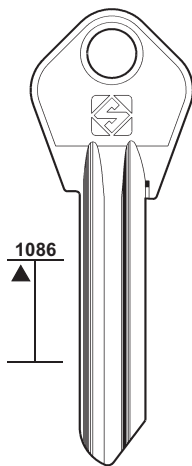

1086

HAK1

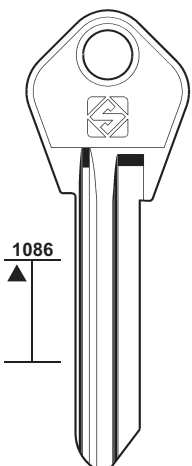

1086

HAK2

HAK6

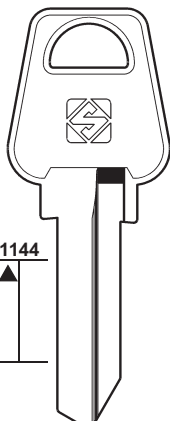

1144

HAK3

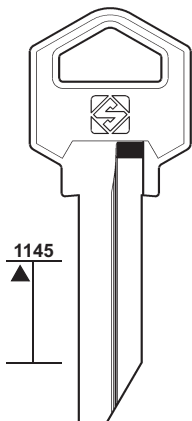

1145

HAK4

PER / FOR
KESO (CH)
ALA
FIAM
JPM
LIPS
SARGENT

KEYA (E)
+ MELSMETALL (122)

KFV (D)
COMBA
FCV
FLIETHER
GIESCHE
GÖTZ
GRAF
HSA
NICO
SCHÜCO
SEN

KHARKOV (UA)



106

PER / FOR**KIENZLE (D)**
VDO**KIEV (UA)**
METIZ**KIFERM (F)**

ATAL
 CASH-BOX
 DEF
 GB
 HÄFELE
 IJN
 JU
 LAS
 METEOR
 ORDO
 RENZ
 SEIM
 TEEN HAAF
 WESCO
 + LAS (110)
 + RICOUARD (146)

KILT (F)

VACHETTE (180)

KIMA (D)

CES (42)

KIND (D)

CES (41-42)
 HOPPE (93)

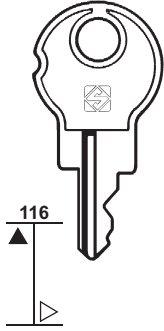
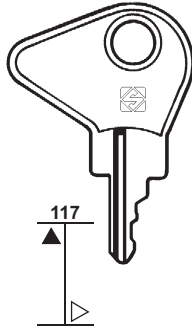
**PER:
FOR:****KIENZLE****KZ1****KZ2**

1

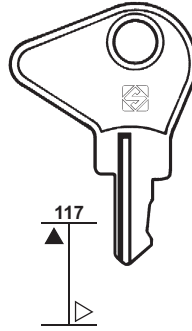
**KZ3**

2

VDO

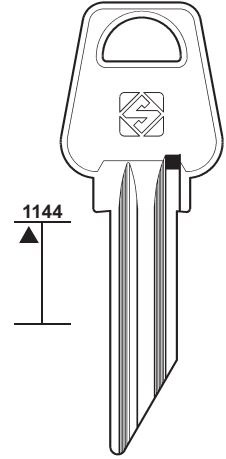
KIEV**MTZ1**

METIZ

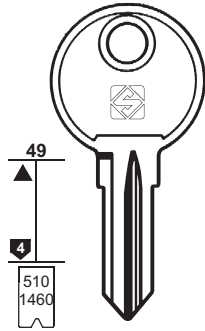
**PER:
FOR:****KIFERM****KI4**

... 1-50
 ... 167
 X ... 167

**KI4R**

... 12359
 U ... 12359

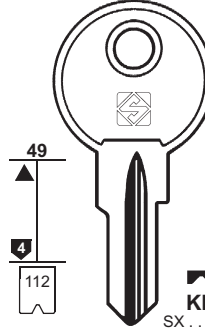
**KI5**

TX ... 1-275

**KI5R**

SX ... 1-275
 XT ... 1-75
 RX ... 1-275

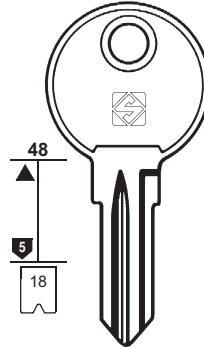
**KI6**

W ... 1-224

**KI6R**

Z ... 1-224

**KI12**

... 151-218
 ... 101-150
 ... 1116-7776
 H ... 1116-7776
 E ... 425-499

**KI12R**

... 1-68
 ... 51-100
 H ... 500-574
 E ... 1116-7776

**KI7**

XY ... 1-275

**KI7R**

ATAL - IJN - JU
 LAS - METEOR
 RENZ - TEEN HAAF

**KI10**

Y ... 1-224

**KI10R**

C ... 1-224
 CA ... 1-224

DEF - GB
 LAS - ORDO

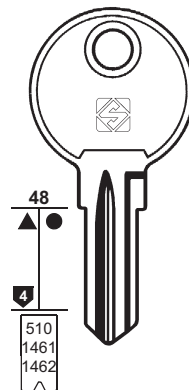
**PER:
FOR:****KIFERM****KI9**

... 226-293
 ... 1-2-3

F ... 80-130
 ... 258

**KI9R**

... 76-143
CASH-BOX

DEF - HÄFELE
 LAS - WESCO

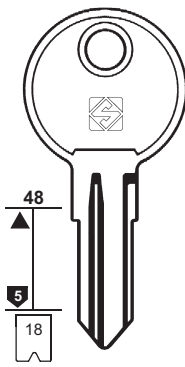
**KI13**

P ... 1-224

LAS

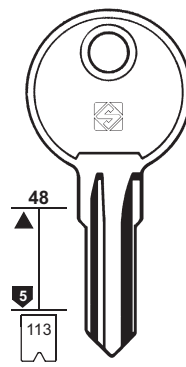
**KI16**

EX ... 1-224

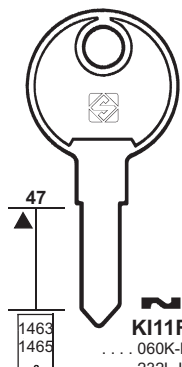

LAS

**KI11R**

... 060K-K660
 ... 232L-L332

**KI11**

TL ... 1-50

... 232K-K332

**KI15**

S ... 1-20

**KI15R**

T ... 1-20

SEIM

PER: FOR:	KING	KIROVSMACH	KISHINEV	

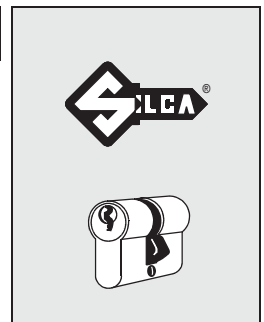

107

PER / FOR
KING (RC)
KIROVSMACH (RUS)
KISHINEV (MD)
KITTY (RC) 👁️ ABLOY (4)
K+K (I) 👁️ TAMPALINI (164)
KKL (A) WB
KMF (GR)
KNAPP (D) 👁️ CES (41-42)
KNAUS (GB) 👁️ EURO LOCKS (71)
KOBE (RUS)
KOPAT (YU)
KÖNIG (D) 👁️ VIRO (186)
KOVER (D) 👁️ EMKA (69)
KP (RUS)
KRAMATORSK (UA)
KREMENCHUK (UA)
KROST (D) 👁️ BUS (39)
KUNERT (D) 👁️ CISA (50)
KURZEMES (LV) 👁️ AISPUTE (12)

PER: FOR:	KKL	KMF	KOBE	KOPAT

PER: FOR:	KP	KRAMATORSK	KREMENCHUK



108

PER / FOR

KVR (D)
CAP
PROTEC

KWIKSET (USA)
BRICARD
E-Z-SET
MASTER
VACHETTE

KYNNARPS (GB)

KYR (I)
SECURITAL (153)

LABOFA (NL)
GEGE (85)

LADA (RUS)

LA FONTE (BR)

PER: FOR: KVR

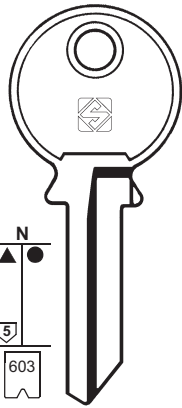

N
▲ ●
5

603

... 1576-1725



CA9

CAP - PROTEC

PER: FOR: KWIKSET

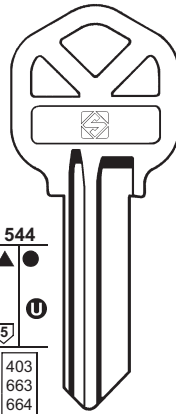

544

▲ ●

U

5

403
663
664



KS1

0-1-2-3-4-5-6-7
1-2-3-4-5-6-7
1-2-3-4-5-6-7-8-9

BRICARD - E-Z-SET - MASTER - VACHETTE

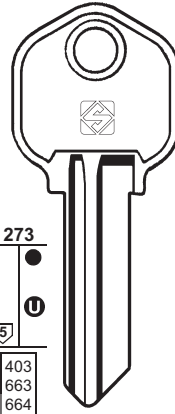

273

▲ ●

U

5

403
663
664



KS1FT

0-1-2-3-4-5-6-7
1-2-3-4-5-6-7
1-2-3-4-5-6-7-8-9

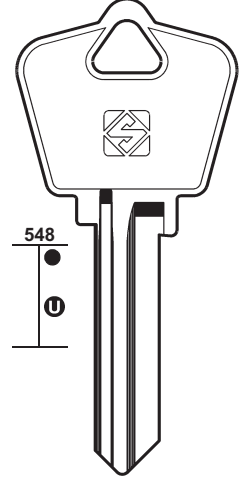

548

▲ ●

U

5



KS4

PER: FOR: KYNNARPS

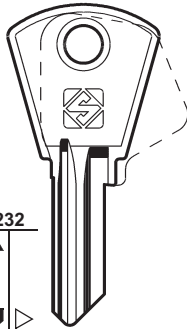

232

▲

5

474

...

201-250



KNA1

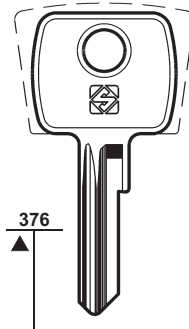

376

▲



KNA2

PER: FOR: LADA

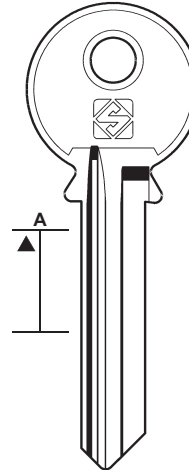

A

▲



LD4

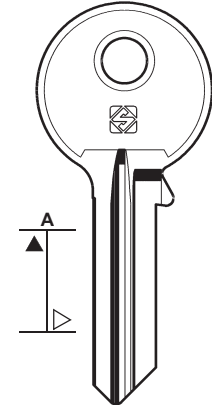

A

▲



LD4R



LD5R

PER: FOR: LA FONTE

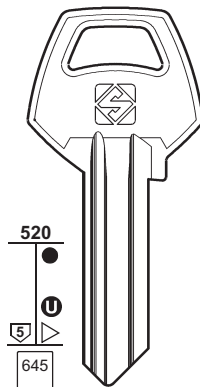

520

▲ ●

U

5

645

...

1-2-3-4-5-6



LAF1

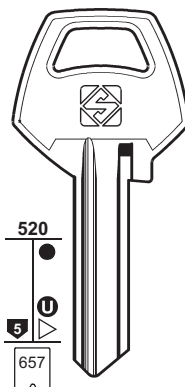

520

▲ ●

U

5

657

...

1-2-3-4-5



LAF2

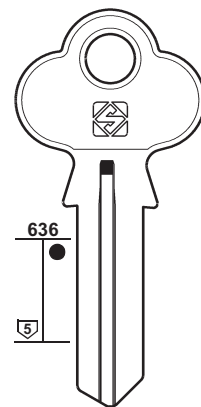

636

▲ ●

5



LAF4R

PER:
FOR:

LA FONTE

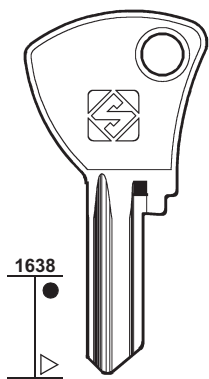

LAF5

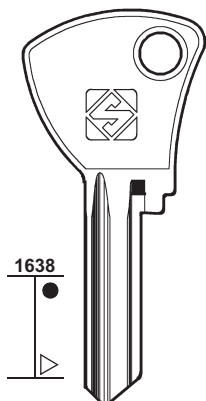

LAF6

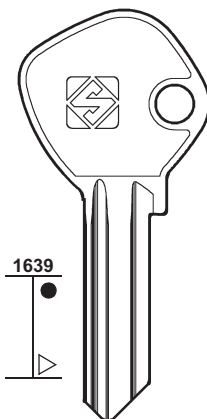

LAF7

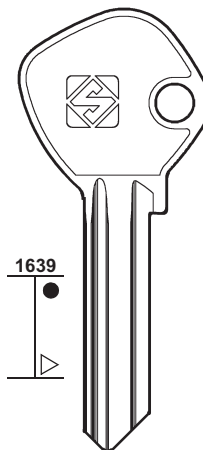

LAF8



109

PER / FOR

LA FONTE (BR)

LAGRANGE (USA)
ILLINOIS (96)

LAMA (YU)
+ MERONI (123)
+ TITAN (167)

LAMPA (USA)
CEMA (41)

LANE (AUS)
CORBIN (54)

LAPERCHE (F)
+ CAS-CISMA (40)
+ DOM (63)
+ RONIS (146-147)

PER:
FOR:

LAMA

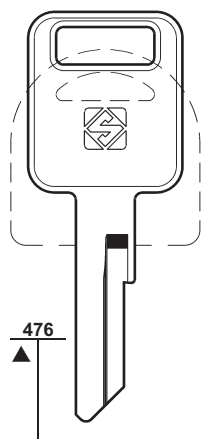

LMA1



LAPERCHE

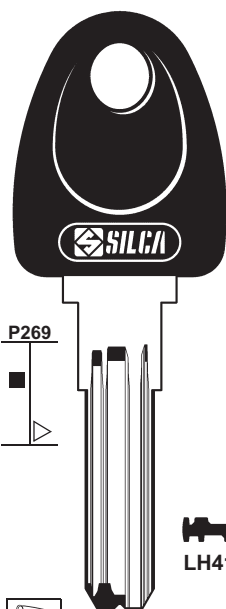

LH41P

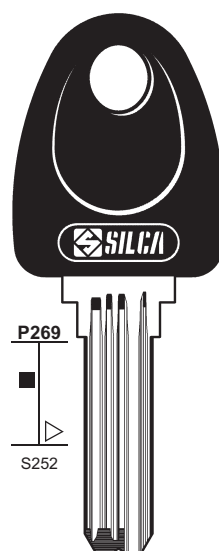

PER:
FOR:

LAPERCHE

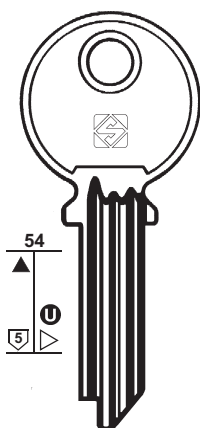

LH1
DM

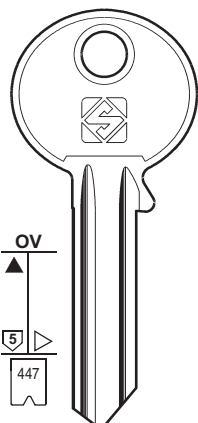

LH4

- C0 1-1000
- C1 1-1000
- C2 1-1000
- C3 1-1000
- B0 1-1000
- B1 1-1000
- B2 1-1000
- B3 1-1000

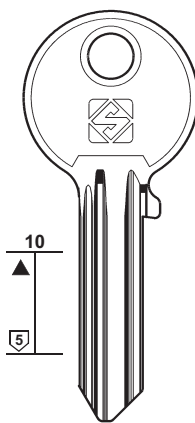

LH40

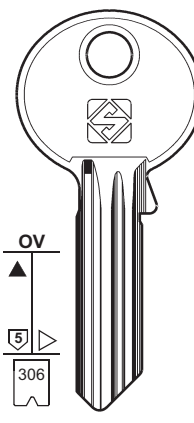

LH42

- L0 1-9999



110

PER / FOR

LAPERCHE (F)

- + CAS-CISMA (40)
- + DOM (63)
- + RONIS (146-147)

LA PORTE (D)

- DLP
- GHE
- PRESTA
- + BOMORO (33)
- + DLP (59)

LAREDO (E)

- + YALE (193)

LARK (RC)

- + GLOBE (87)

LAS (F)

- ATAL
- DUBOIS
- HÄFELE
- KIFERM
- MARCADET
- PK
- RENZ
- RONIS
- STRAFOR
- WESCO
- + KIFERM (106)
- + RICOUARD (146)

PER:
FOR:

LAPERCHE

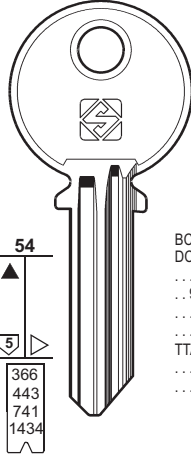

LH5
..... 0-1-2-3-4-5-6-7-8-9
..... 1-2-3-4-5-6-7-8-9
TTP 0-1-2-3-4-5-6-7-8-9
..... 9 1-2-3-4-5-6-7-8-9

LH5R

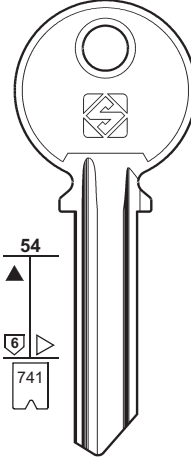

LH10
..... 0123456789
UUP
0123456789

LH10R

LH20
..... 0-1-2-3-4-5-6-7-8-9
TTR
0-1-2-3-4-5-6-7-8-9

LH2
BC 1001-3865
DC 1001-3865
..... 1-2-3-4-5-6-7-8-9
..... 9 1-2-3-4-5-6-7-8-9
..... 15001-16000
..... 16001-18125
TTA 0-1-2-3-4-5-6-7-8-9
..... 13001-13500
..... 1001-3865

LH7R
..... 1-2-3-4-5-6-7-8-9

LH21
..... 0-1-2-3-4-5-6-7-8-9
TTS
0-1-2-3-4-5-6-7-8-9

LH22
..... 0-1-2-3-4-5-6-7-8-9
TTT
0-1-2-3-4-5-6-7-8-9

LH23

LH24

LH25
UUR
0-1-2-3-4-5-6-7-8-9

LH26
UUS
0-1-2-3-4-5-6-7-8-9

LH27
UUT
0-1-2-3-4-5-6-7-8-9

LH28
UUV
0-1-2-3-4-5-6-7-8-9

LH29
UUX
0-1-2-3-4-5-6-7-8-9

PER:
FOR:

LA PORTE

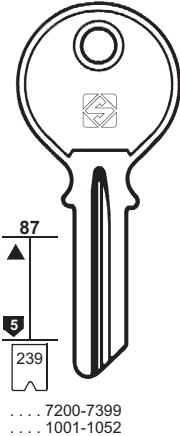

LAP1

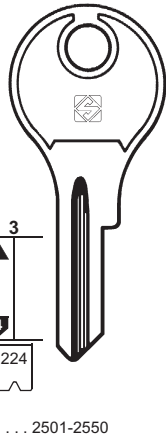

DL1R

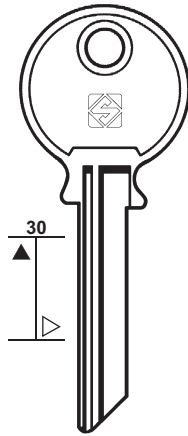

LAP3

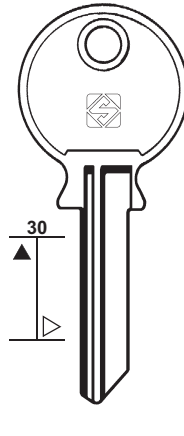

LAP2

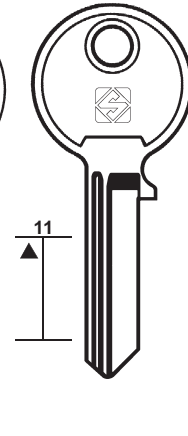

DL3

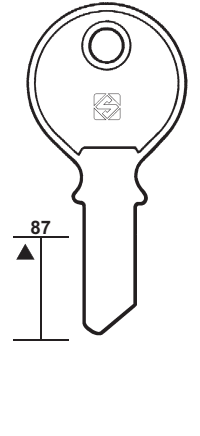

DL2

GHE - PRESTA

DLP

PER:
FOR:

LAS

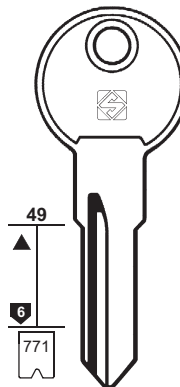

LS3
A ... 1-650

LS10
AB

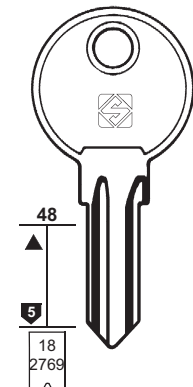

LS1
R ... 1-224
V ... 1-224

DUBOIS - KIFERM
PK - RENZ
RONIS - WESCO

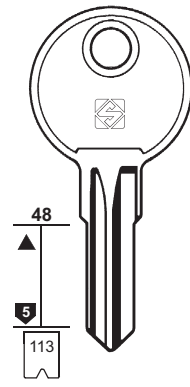

LS1R
V ... 1-224

ATAL - HÄFELE
KIFERM
MARCADET - RENZ

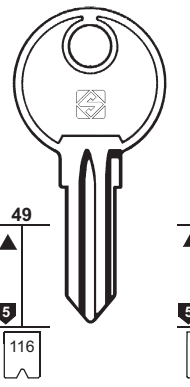

LS2
AX ... 1-224

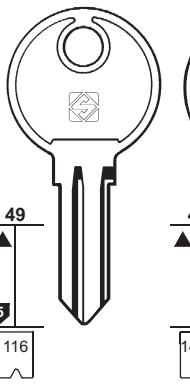

LS7
FH ... 1-400
LH ... 1-400
FH ... 501-550

LS4
U

LS19
FH ... 1-400
LH ... 1-400
FH ... 501-550

LS4R
X

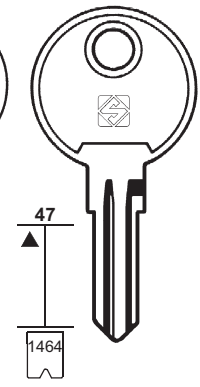

LS12
LS ... 1-60

PER: **LAS**
FOR:

LS13
JH ... 1-100
FH ... 1-400
LH ... 1-400
SH ... 1-400
WH ... 1-400
AA ... 1-50
LH ... 1-60
... 301-675
FH ... 501-500

FORT

LS13R
FM
SH ...
501-550

LS14
MJ ... 1-400
FM ... 1-100
SM ... 1-400
MR ... 001-050
FM ... 501-550
SM ... 501-550

LS14R

LS18
PM ... 1-10

LS5
L

LS6
L231

LS9
AT ... 1-650

LS9R
TA ... 1-650

LS11
RM ... 1-2000
KT ... 3001-4000
KT ... 7001-8000

LS11R
TK ... 4001-5000

MARCADET - RONIS

ABBES - ORDO

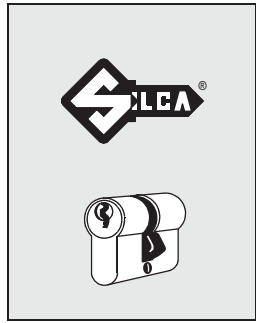

111

PER / FOR
LAS (F)
ABBES
FORT
MARCADET
ORDO
RONIS
+ KIFERM (106)
+ RICOUARD (146)

PER: **LÅSBOLAGET**
FOR:

LEGALLAIS

LB11

LB10

LB19

LB18

LB23

LB22

LB28
6543210

LB29

LB32

LB33

LB34

LB35

TANLOCKS

LEA1

HB

LÅSBOLAGET (S)
TANLOCKS
+ KABA (102)
+ SIS (156)

LAUDON (RSA)
L & F (117)

LBLM (E)
FORTIS (81)

LE FEBURE (USA)
CIFIAL (47)

LEGALLAIS (F)
HB

LEGGE (GB)

LEHEMANN (D)
MLM (127)

LEN-LOK (AUS)
ROLL-A-DOOR
+ LOCKWOOD (115)

LG (F)
ARROW (18)

PER: **LEGALLAIS**
FOR:

LEGGE

LEN-LOK

LEA2

LEG1

LEG2

LEG3
PASSEPARTOUT

LL1
LL

ROLL-A-DOOR



112

PER / FOR

LINCE (E)
ICSA
+ ALPHA (15)

LION (USA)
JUNKUNC (101)

LIONA-LIOX (F)
RONIS (146)

LIPS (NL)
+ DALWA (57)

PER:
FOR:

LINCE

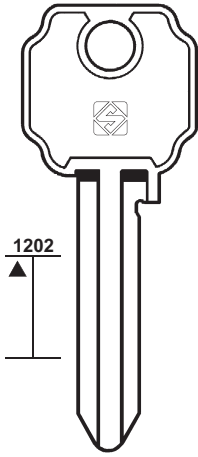

LC10
K

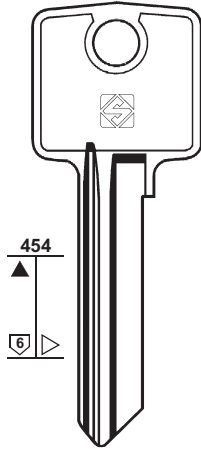

LC7 M LC7R M

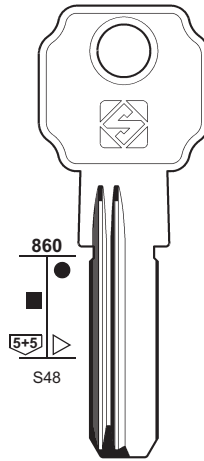

LC14R X
ICSA

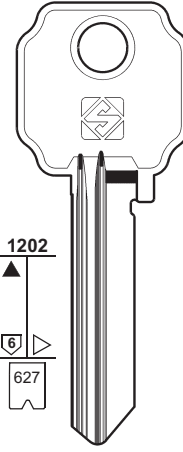

LC15 S LC15R S
1-2-3-4-5-6-7-8

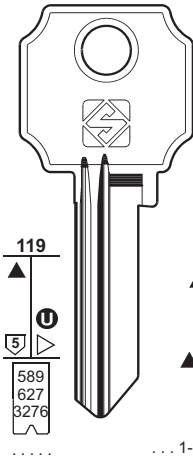

LC11 R
1-2-3-4-5-6-7-8
mm 50-60-70
LC11R R
LC12 B



PER:
FOR:

LINCE

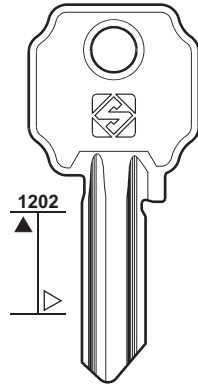

LC13 U
LC16 U

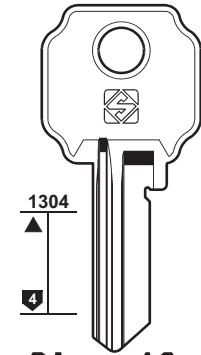

LC13 D1 LC13R D1

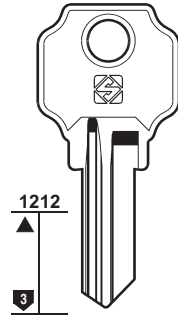
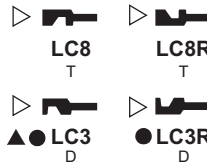

LC17 LC17R

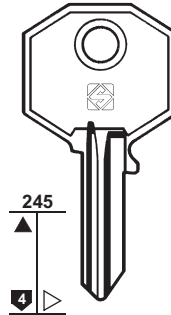

LC9R

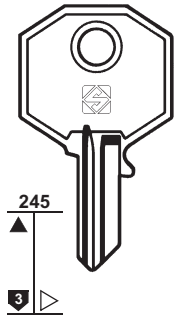

LC5 F LC5R F



PER:
FOR:

LIPS

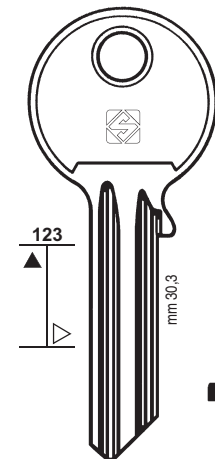

LP12 22 LP12R 25



LP2 29 LP2R 34

LP38R 34D

LP36R 34B

LP35R 34A

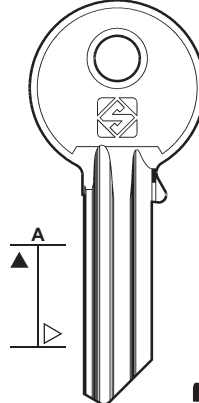

LP13 23 LP13R 26



LP5 30 LP5R 35

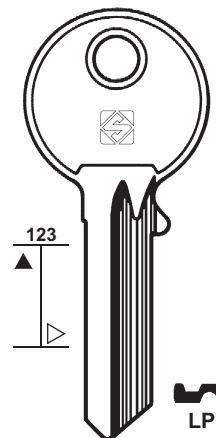

LP17R A



LP19R D

LP20R 35C

PER:
FOR:

LIPS

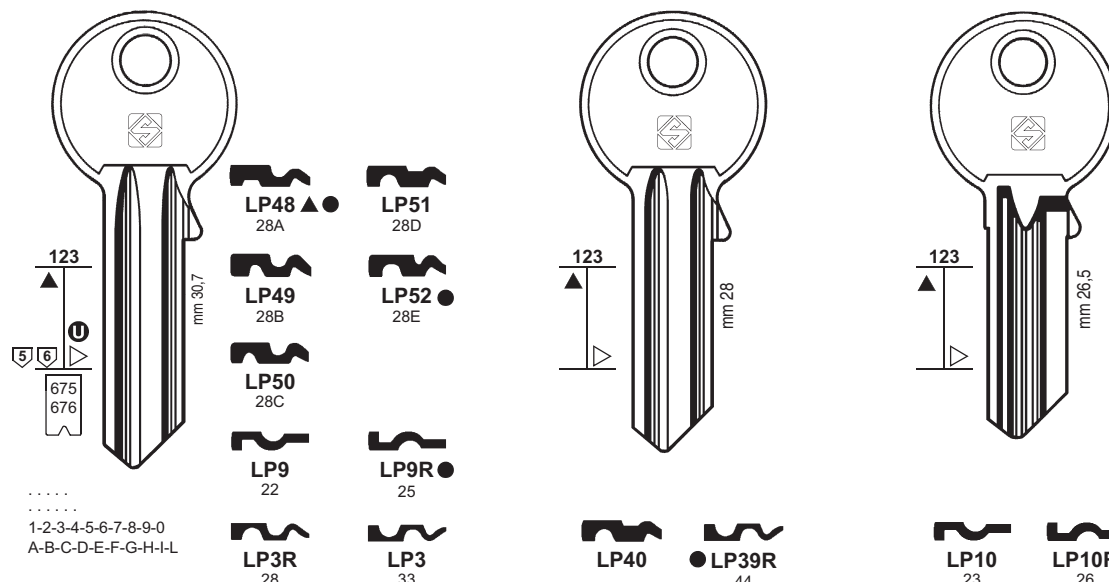

.....
1-2-3-4-5-6-7-8-9-0
A-B-C-D-E-F-G-H-I-L



113

PER / FOR

LIPS (NL)
+ DALWA (57)

LIPS-VAGO (I)
 PREFER (143)

LISTA (D)
 DOM (62)

LITTO (B)
ANKERSLOT
BKS
CORBIN
+ ANKERSLOT (16)
+ CORBIN (53)

PER:
FOR:

LIPS

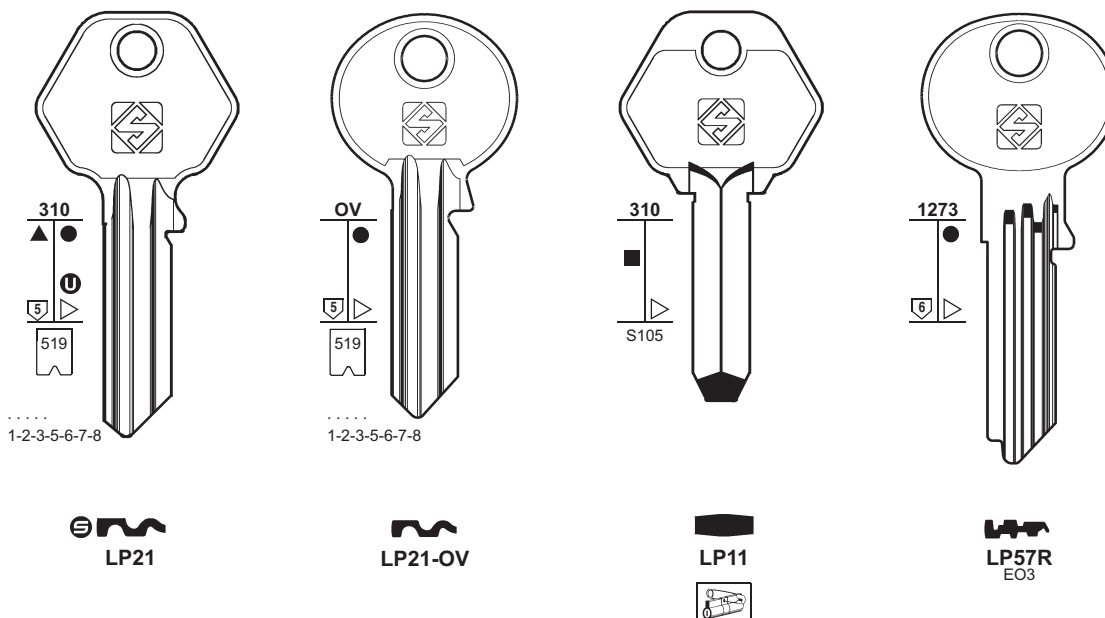

.....
1-2-3-5-6-7-8

.....
1-2-3-5-6-7-8

PER:
FOR:

LIPS

LITTO

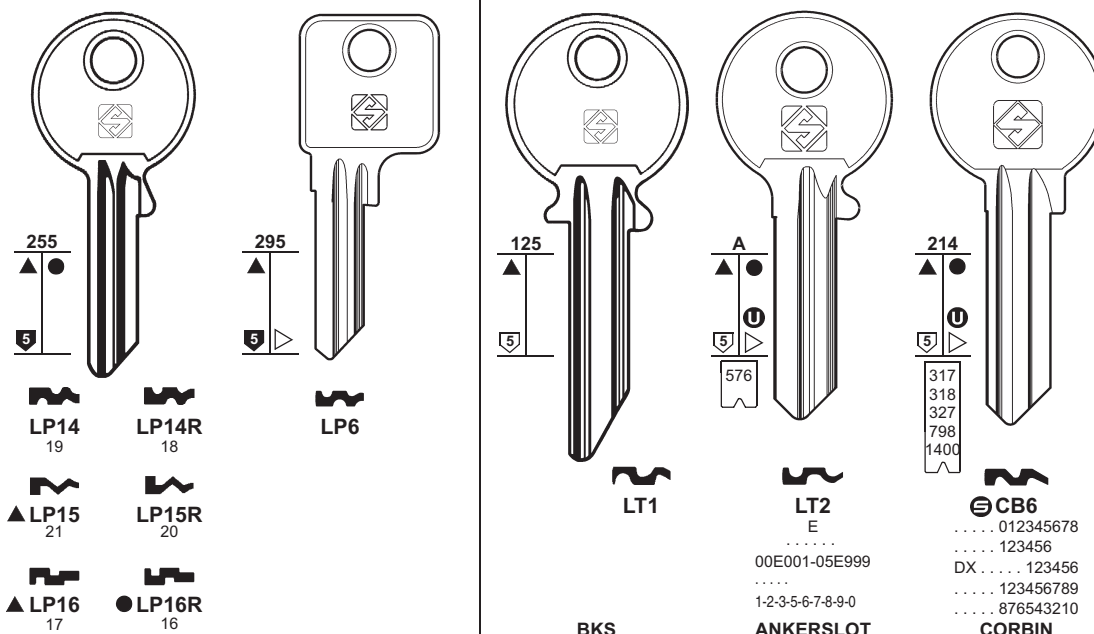

.....
5

.....
5

.....
5

.....
576

.....
317
318
327
798
1400

.....
00E001-05E999
.....
1-2-3-5-6-7-8-9-0

.....
012345678
.....
123456
DX..... 123456
.....
123456789
.....
876543210

BKS
ANKERSLOT

CORBIN



114

PER / FOR**LITTO (B)**

+ ANKERSLOT (16)

+ CORBIN (53)

LM (S)

+ TEKA (165)

L.M.C. (D)

+ HUWIL (94)

LML (I)

+ MORI E. (128)

LN (BR)**LOB (PL)**

BRICARD

EXPRES

REDY

ROSTEX

YETI

+ FAB (74)

+ MCM (121)

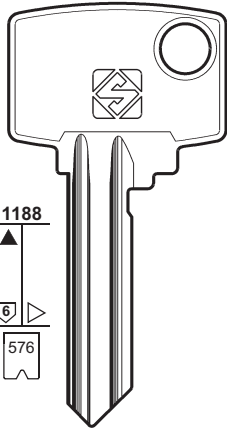
LOCKSYS (BG)**LOCKWELL (BR)****PER:
FOR:****LITTO****LN**

..... 1234567890

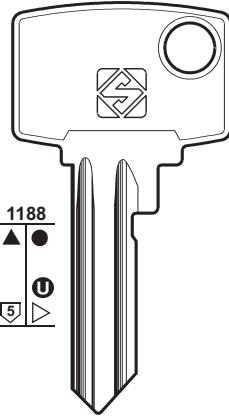
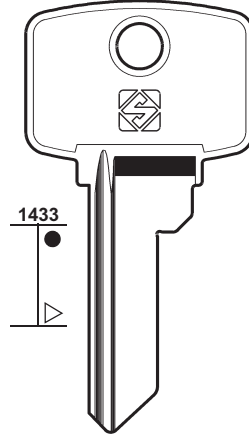
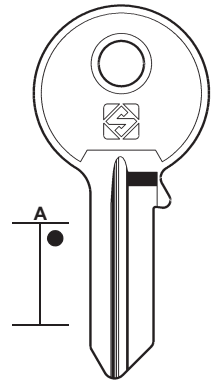
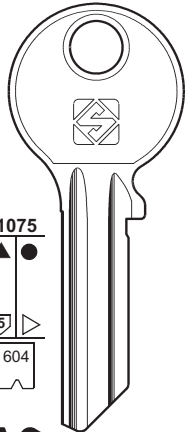
LT3**LT4****LT5****LN1****PER:
FOR:****LOB****YT16****YT15**

..... 0-1-2-3-4-5-6-7-8-9

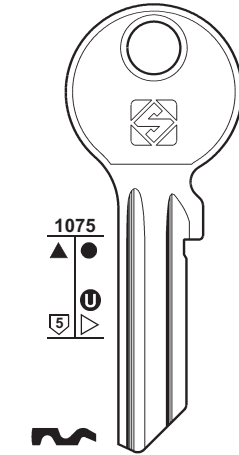
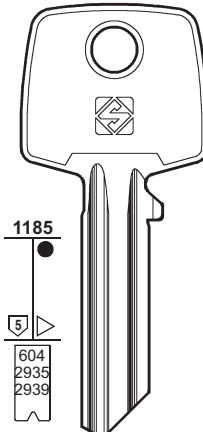
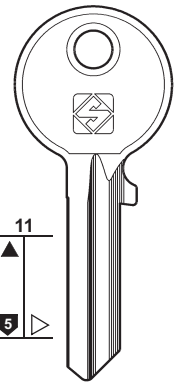
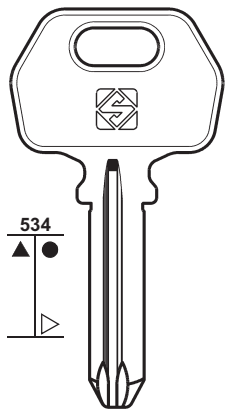
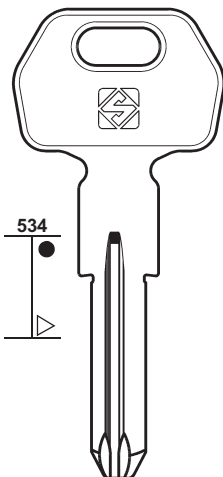
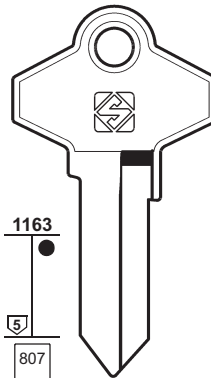
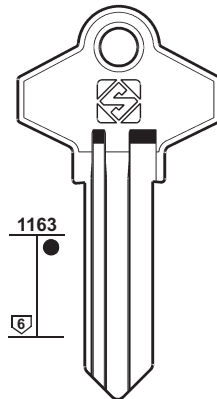
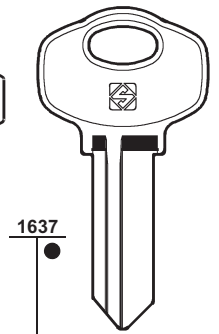
**BRICARD - EXPRES
REDY - YETI****YT16X****YT15X****YT15RX****YETI**..... 0123456789
..... 123456789ABC**LOB16****YETI****LOB1** **LOB1R****ROSTEX****PER:
FOR:****LOCKSYS****LOCKWELL****LCK1R****LCK1RX****LOC1****LOC3****LOC4**

..... 1-2-3-4-5-6-7-8

PER:
FOR:

LOCKWOOD

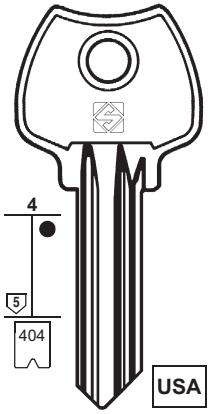

LW1 ▲ LW1R
.....
0-1-2-3-4-5-6-7-8-9

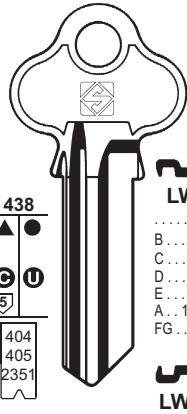

LW20 ▲ LW20R
..... 0123456789
X..... 100-27787
HX..... 1000-1500

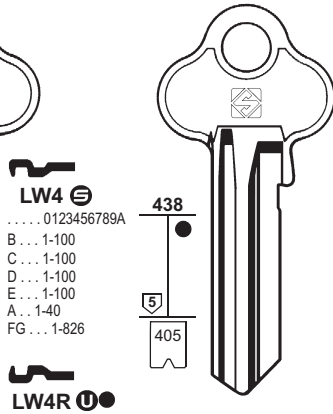

LW4 ⊕
..... 0123456789A
B... 1-100
C... 1-100
D... 1-100
E... 1-100
A... 1-40
FG... 1-826

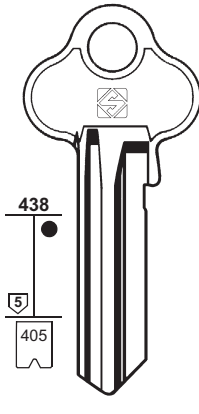

LW40 ▲ LW40R
.....
0-1-2-3-4-5-6-7-8-9-A

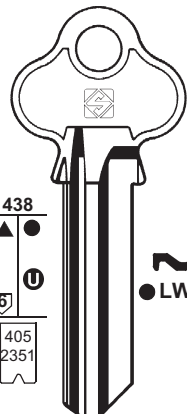

LW5 ● LW5R
..... 0123456789A
B... 1-100
D... 1-100
F... 1-100
A... 1-40
C... 1-40

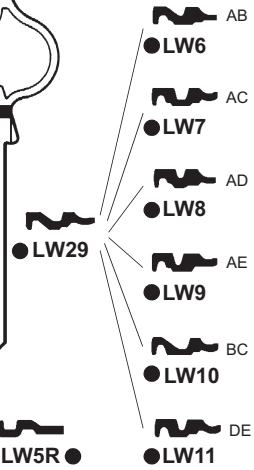

115

PER / FOR

LOCKWOOD (AUS)
GAINSBOROUGH

LOCKWOOD (AUS) (USA)
LEN-LOK

GAINSBOROUGH

PER:
FOR:

LOCKWOOD

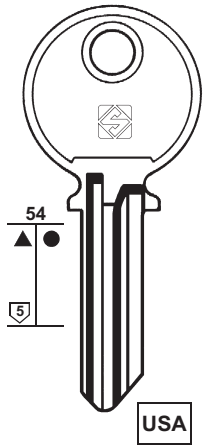

LW2 ● LW2R

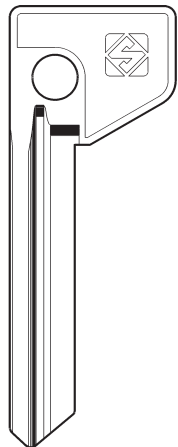

LW21R
.....
0-1-2-3-4-5-6-7-8-9-A

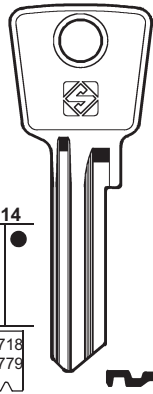

LW28
..... 1-3720
..... 3001-6720
..... 456789A

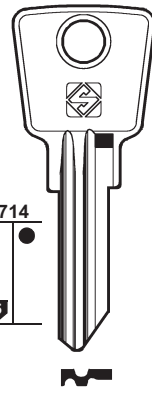

LW14
24A

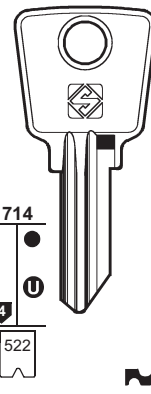

LW3 ● LW12R
..... 1-960
L... 1-960
L... 151-250
CL... 1-1000 Y... 1-960



PER:
FOR:

LOCKWOOD

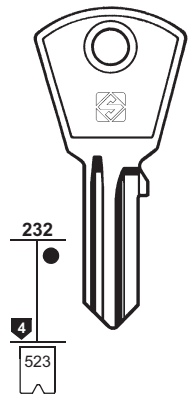

LW15
..... 1-2100

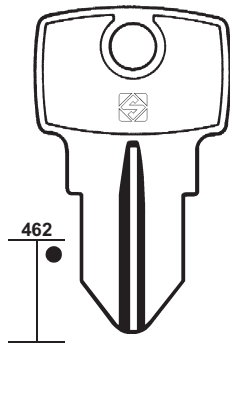

LL1
LL

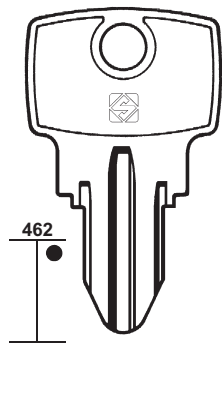

LW16
R

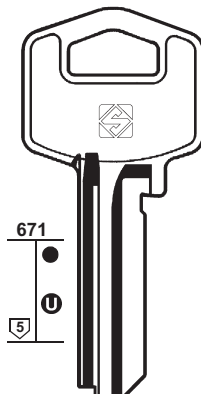

LW17
N

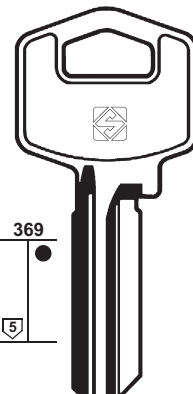

LW18

LW19



LEN-LOK



116

PER / FOR

LOCKWOOD (AUS) (USA)

LOGO (I)

CISA (48-50)

LOK 2000 (I)

CISA (50)

LORI (USA)

EAGLE (67)

LOTUS (RC)

YETI (198-199)

L & F (GB)

ATAL
DAD
DOUBLE SAFE
EURO LOCKS
IBFM
MIBRA
TELFORD
ULTRA
UTZ

+ CHICAGO (46)

+ EURO LOCKS (71)

LOCKWOOD

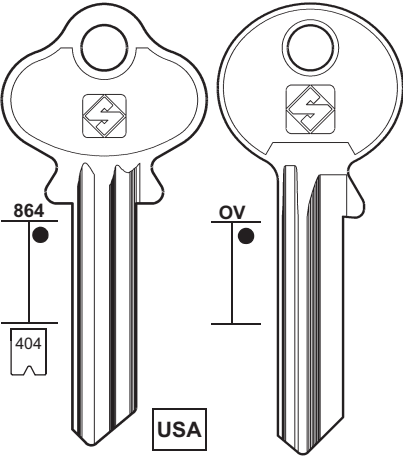

LW23

..... 0123456789

LW24

LOWE & FLETCHER

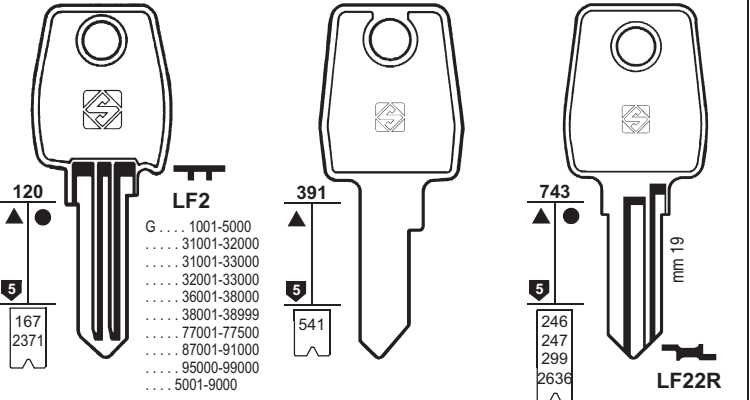

LF2
G ... 1001-5000
..... 31001-32000
..... 31001-33000
..... 32001-33000
..... 36001-38000
..... 38001-38999
..... 77001-77500
..... 87001-91000
..... 95000-99000
..... 5001-9000

LF26
..... 77001-77500
..... 95000-99000

LF13
..... 2001-4000

LF17
ATAL

LF23R
EL ... 1-500
..... 1001-1100
93 ... 401-900
..... 9001-9500
EL ... 9001-9500

LF22
93 ... 201-400
..... 93901-94000

LF16

LF16R

LF15R
..... 90901-90975

LF22R

LF22
..... 93901-94000

DOUBLE SAFE
EURO LOCKS

DAD - MIBRA - UTZ

LOWE & FLETCHER

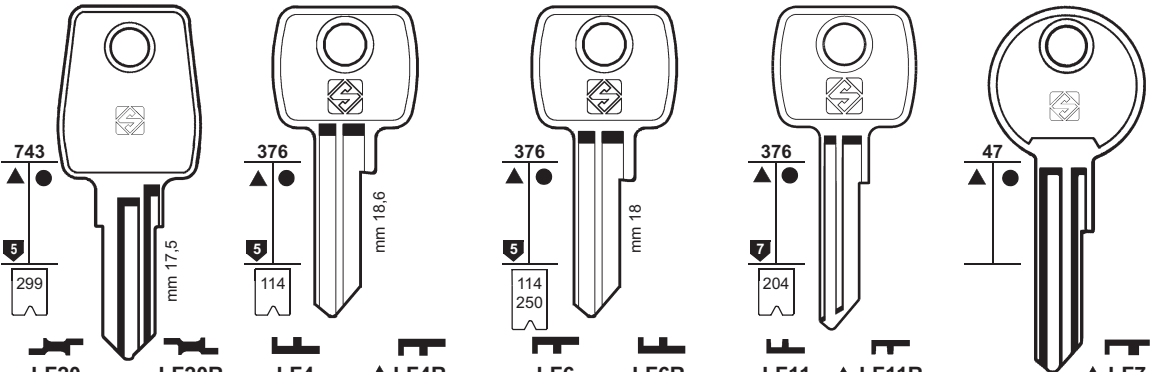

LF20
..... 93901-94000

LF20R

LF4
60 ... 1-400
90 ... 1-200
92 ... 1-400
..... 1-400
GHM ... 1-155
M ... 1-400
92 ... 401-600
99 ... 1-400
RV ... 1-400
RVM ... 1-400
SP ... 1-400
GS ... 1-400
... ES1
... EV1

LF4R
99 ... 401-600
92 ... 501-700

LF6

LF6R
90 ... 1-200
..... 1-400
91 ... 201-350
GH ... 1-400
SS ... 1-400
92 ... 401-600
GS ... 1-400

LF11
76 ...
1-400
.....
70001-71200

LF11R
M ...
70001-71000

LF7

LF18R

LF42R
FFE ... 1-100
NF ... 1-30

LF52

LF8

LF8R

UTZ

ULTRA

TELFORD

LOWE & FLETCHER

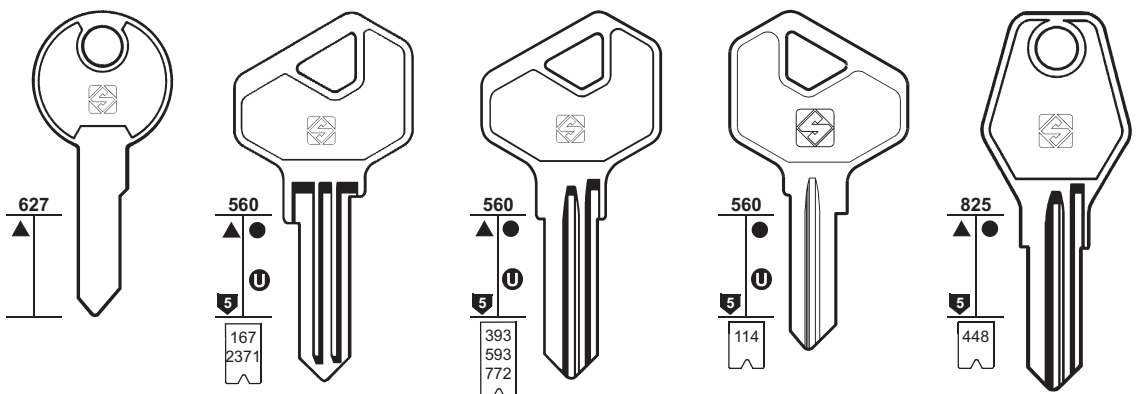

LF29R

LF24

LF25
V ... 1-88
E ... 101-600
RE ... 101-600
..... 5001-9000
..... 31001-33000
..... 36001-38000
..... 87001-91000

LF27

LF27R

LF43R
92 ... 601-800

LF37
R ... 151-650
T ... 1-1000
S ... 1-1000
..... 9001-9494



AUSTRALIA



AUSTRALIA



PER:
FOR:

LOWE & FLETCHER

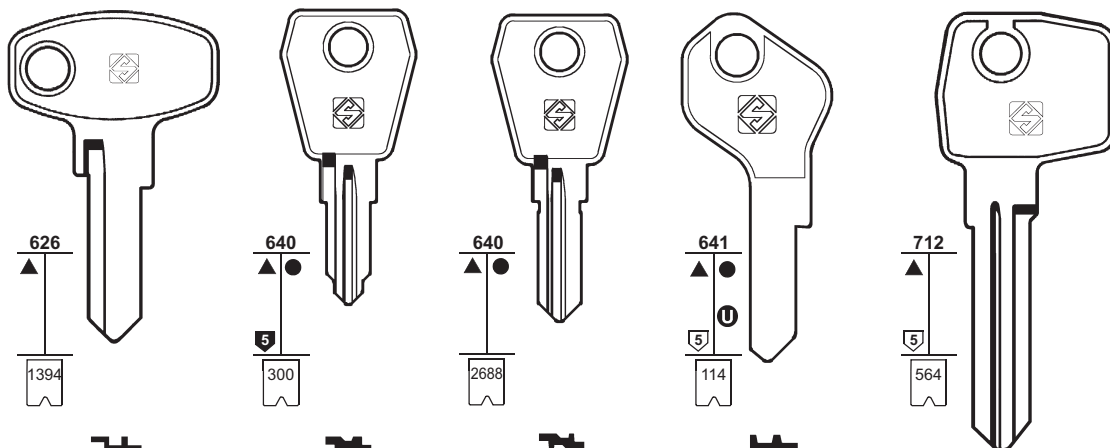

LF28R
RO2...
101-215

LF30R
... 801-900
... 901-1000

LF61R
... 6601-7100

LF31R
60... 001-400
... 1-400
92... 1-400
M... 1-400
91... 201-350
... ES1
... RV1

LF33 68001-70000

LF51R

EURO LOCKS
LAUDON

BASI - DAD

EURO LOCKS



117

PER / FOR

L & F (GB)
BASI
DAD
EURO LOCKS
LAUDON
ROLL-A-DOOR
+ CHICAGO (46)
+ EURO LOCKS (71)

PER:
FOR:

LOWE & FLETCHER

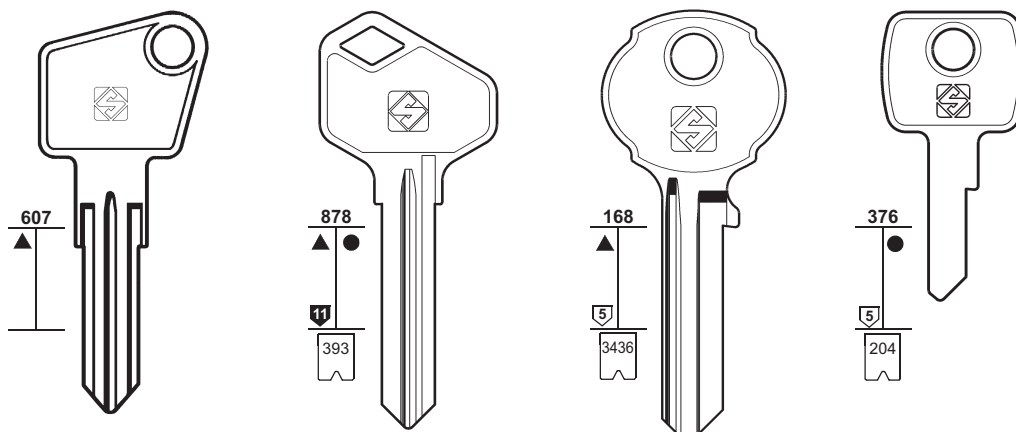

LF34

LF39
09... 1-900
29... 1-478

LF47
A... 12000-13049

LF54
75... 001-200



AUSTRALIA
ROLL-A-DOOR

PER:
FOR:

LOWE & FLETCHER

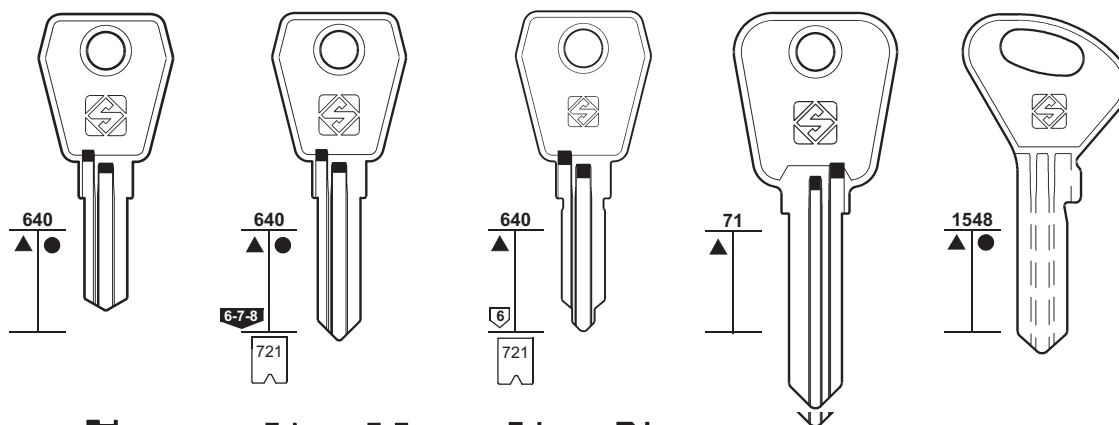

LF46R

LF45R ▲ **LF53**
ME... 001-300
... 18000-18999
... 19000-19999
... 35000-35499
... 78000-78999
... 79000-79999

LF58R ▲ **LF59R**
AA... 000-999

LF56

LF60





118

PER / FOR

LOXEM (GB)

LR (I)
MORI E. (128)

LUCO (RC)
GLOBE (87)

LUCKY (RC)

LUMA (E)

LUME (I)
GIUSSANI (86)

LUNA (I)
P.C.
(CORTELLEZZI) (139)

LUX (ET)

LYF (E)

M (I)
CAS-CISMA (40)

MAFOR (F)
RONIS (146)

MAQUET (F)
DOM (62)

MARCADET (F)
LAS (110-111)

MARCO (D)
DOM (62)

MAGNUM (I)

MARIANI (I)

MARK (RC)
TRI-CIRCLE (173)

MARLIN (I)
BOSS (33)

MARS (RC)

MASTER (USA)
+ ABUS (8)
+ KWIKSET (108)
+ TOK-WINKHAUS (168)

PER: **LOXEM**

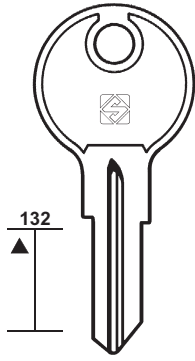

LXM1R



FOR: **LUCKY**

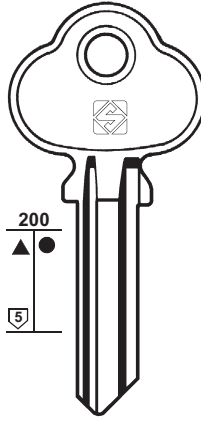

LU1

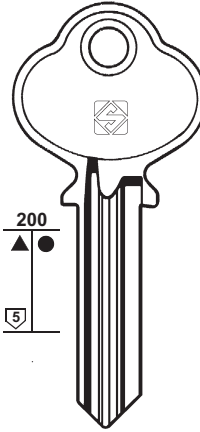

LU2

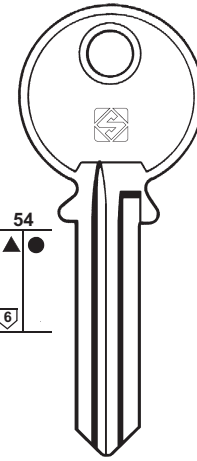

LU3R

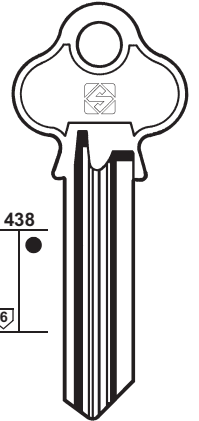

LU4

PER: **LUMA**

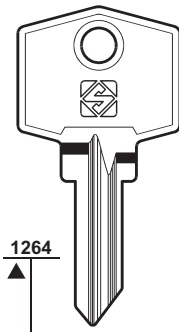

LM3

LM3R

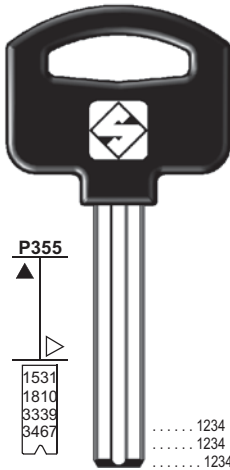

1531 1234
1810 1234
3339 1234
3467 01234

LM4

LM4R

LM5P



FOR: **LUX**



LX1

LX1R



LYF

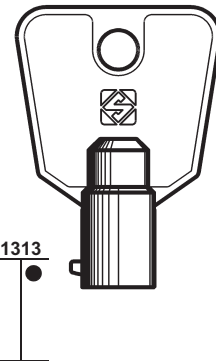

LYF1T

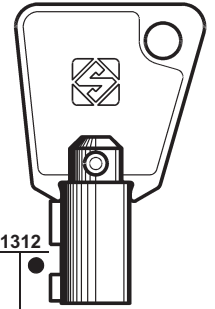

LYF2T



S536
S818
..... 654321
..... 76543210

PER: **MAGNUM**

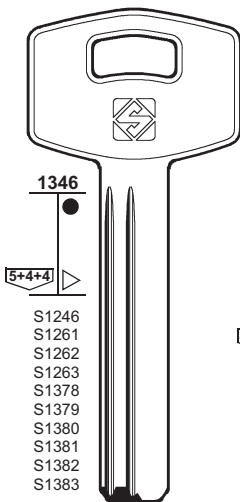

MGN1R

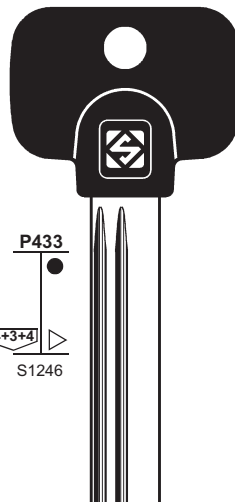

MGN1RP



FOR: **MARIANI**

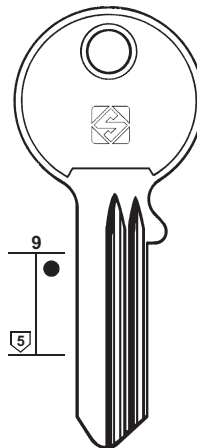

MR1

MARS

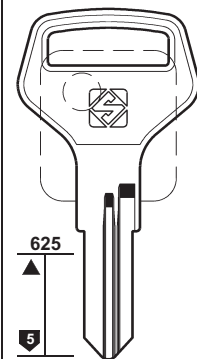

MAR1

MASTER

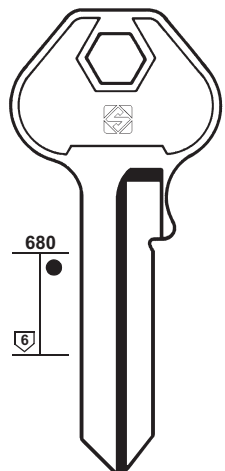

MS8



PER: **MASTER**
FOR:

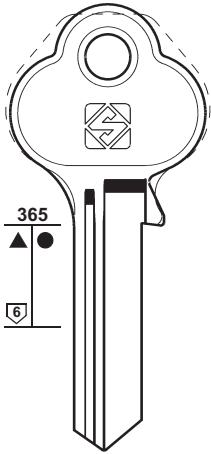

MS19

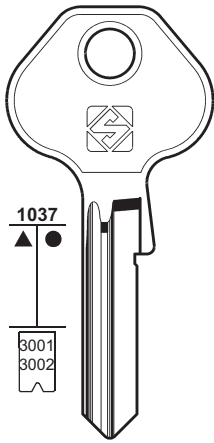

MS17
..... 01234567
410K 001-999

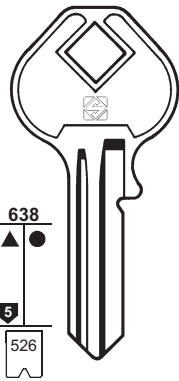

MS6 **MS5R**
10T 1-1000

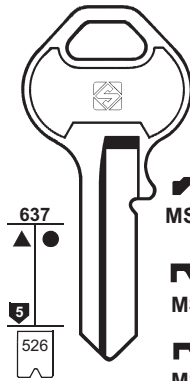

MS13R

MS9R

MS4R

..... 1-9800
34H 601-912

MS3

MS3R

10L 1-1000

MS11

MS11R



119

PER / FOR

MASTER (USA)
HAMPTON
+ ABUS (8)
+ KWIKSET (108)
+ TOK-WINKHAUS (168)

MASTER LOCK (RC)

MATTEY (F)
SUREX (163)

MAUER LOCKS (BG)
DEKABA
+ DEKABA (57)

PER: **MASTER**
FOR:

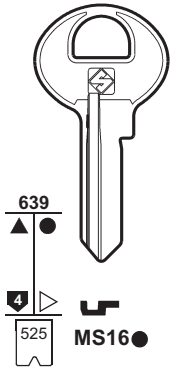

MS16

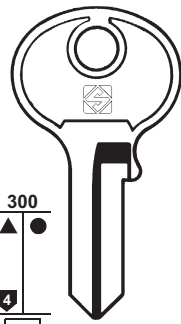

MS7

MS1

MS12

P 1-850
T 1-3000
X 1-1500

..... 3201-4000
A 101-2100
A 5501-6400
U 1-3250

X 2001-3000
X 5001-6000
M 2001-4515
J.U. 01-50



mm 30

HAMPTON

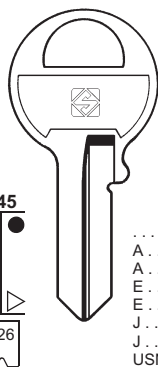

MS2

1K

..... 1-3200
A 101-2100
A 5501-6400
E 1-700
E 2001-3000
J 301-1250
J 2001-2150
USN 1-4500
W 0-3500
WO 1-1000
X 2001-3000
X 5001-6000
..... 4201-5000
..... 5001-6000
..... 6001-7000
..... 7001-8000
..... 8001-9000
..... 9001-10000
M 2001-4515



mm 40

HAMPTON

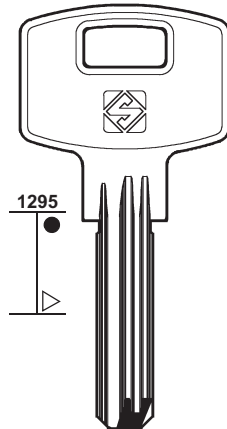

MS23

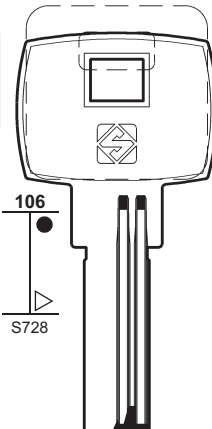

MS22



PER: **MASTER** **MASTER LOCK** **MAUER**
FOR:

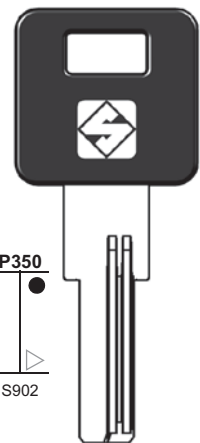

MS20P



MS21AP

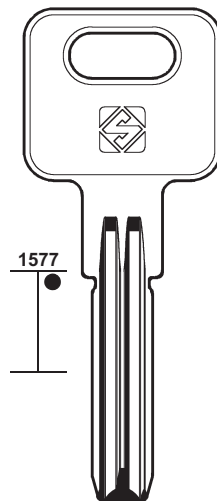

MSL1

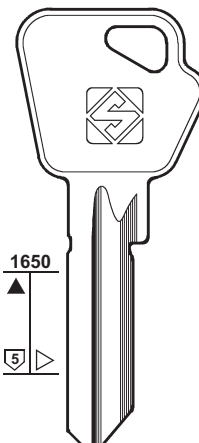

MAU1R

DEKABA

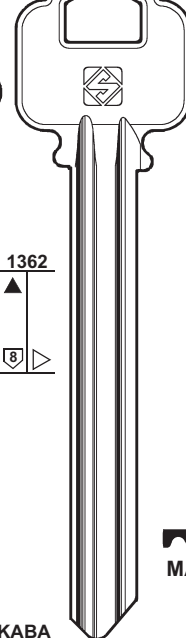

MAU2



120

PER / FOR

MAUER LOCKS (BG)
DEKABA
+ DEKABA (57)

MAUSER (D)
 CES (42)
 HOPPE (93)
 HUWIL (94)

MAXIGARD (F)
 GABON (84)

MAXUS (GB)

MAY-TAY (IL)

MBB (D)
 CES (42)

MCM (E)
MONDRAGON

PER: FOR:	MAUER	MAXUS	MAY-TAY
	 1362 1362 MAU3 MAU4 DEKABA	 1671 5 MXU1R	 1355 MAY1

PER: FOR:	MCM								
	 128 5 MC1	 129 5 6 U 595 749 MC1R	 129 5 6 MC2 1..... 1-2-3-4-5-6-7 0-1-2-3-4-5-6-7	 129 5 6 MC2R 1..... 1-2-3-4-5-6-7	 129 5 6 MC7	 129 4 MC5	 129 3 MC5R	 129 MC6	 129 MC6R
	MONDRAGON								

PER: FOR:	MCM					
	 129 5 U 3116 MC4	 454 7 6 748 750 MC4R	 459 MC3	 890 MC17	 890 MC8	 890 MC13
 0-1-2-3-4-5-6-7 MONDRAGON					

PER:
FOR:

MCM

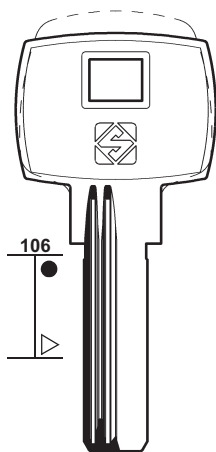

MC14R

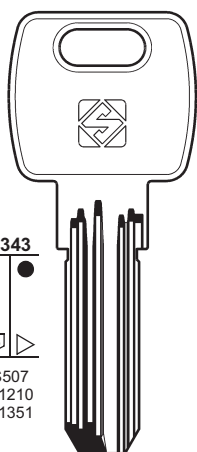

S507
S1210
S1351

..... 162-17HH6

MC15R
E8

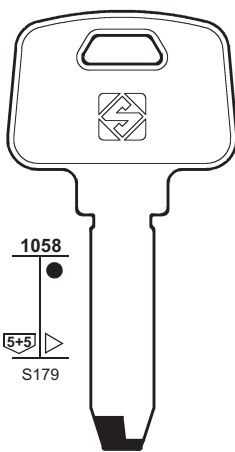

S179

MC9X
4SS

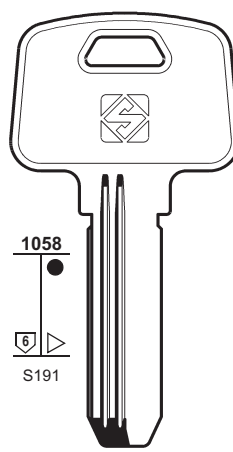

S191

MC10R
4SE



LOB - YETI

TROMER



121

PER / FOR

MCM (E)
LOB
TROMER
YETI

MECALUX (F)
AGA (10)

MECO (D)

MEDECO (USA)

PER:
FOR:

MCM

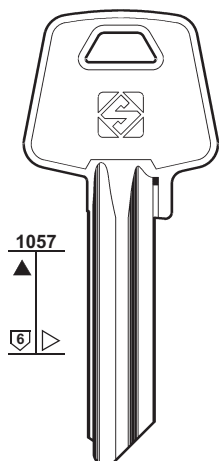

MC11
X

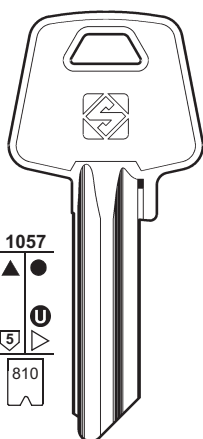

E..... 11241-79868
X..... 123456789

MC12

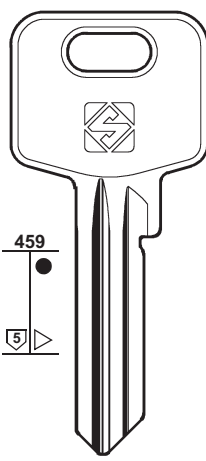

MC18R

B

MC19R

C

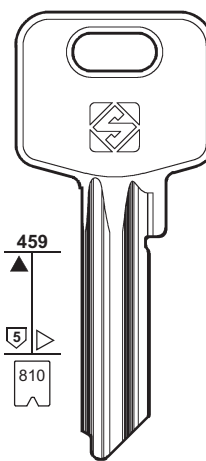

MC20

X..... 1234567890
E..... 11241-79868

PER:
FOR:

MECO

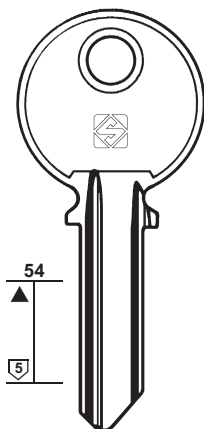

MEC1

MEDECO

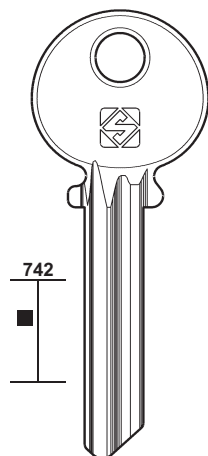

MD4

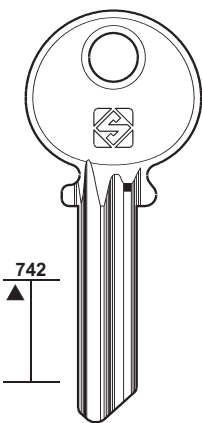

MD7

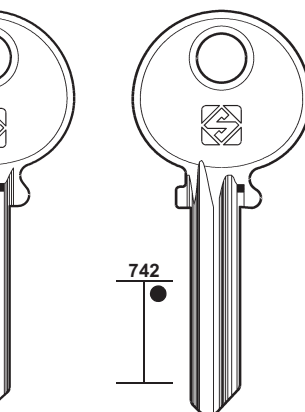

MD11

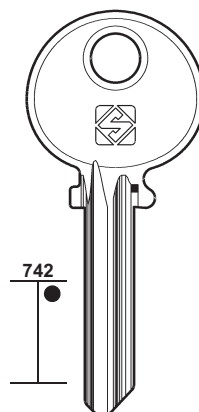

MD6

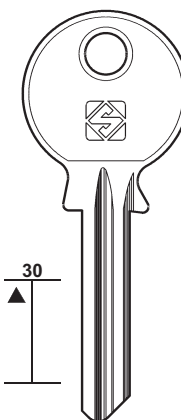

MD8R

MD1R



122

PER / FOR

ME-FA (RC)
BRABANTIA
CLAUSOR

MEGA (RO)

MELSMETALL (D)

BURG
FARCE
HBC
KEYA
SES
+ BURG (37)

MENOVA (D)

DOM (61)

MERCUR (D)

JOWIL (100)

MERLE (RA)

MERMIER (F)

CORBIN (52-53)

PER:
FOR:

ME-FA

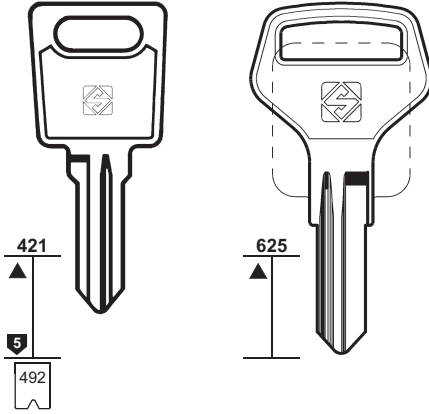

421
5
492

625

MF1R
... 1-100
... 101-200

MFA1



BRABANTIA - CLAUSOR

MEGA

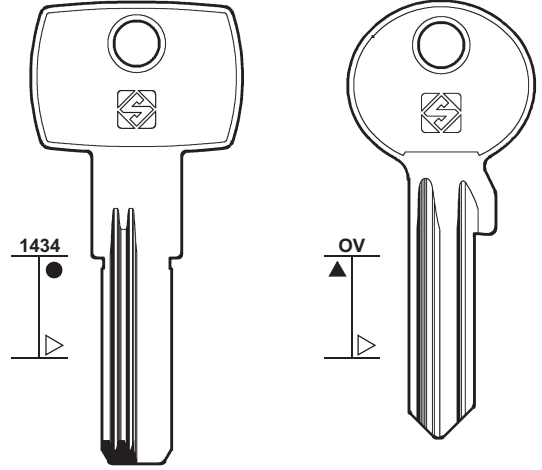

1434

OV

MEG1R



MEG2

PER:
FOR:

MELSMETALL

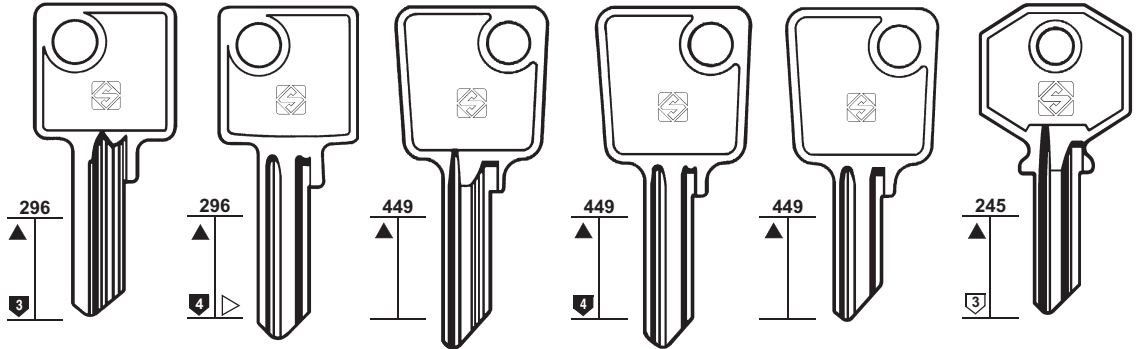

296
3

296
4

449

449
4

449

245
3

ME1

ME3

ME6

ME7

BUR6

ME2R

ME8

ME4

ME4R

ME5

ME5R



HBC



BURG

PER:
FOR:

MELSMETALL

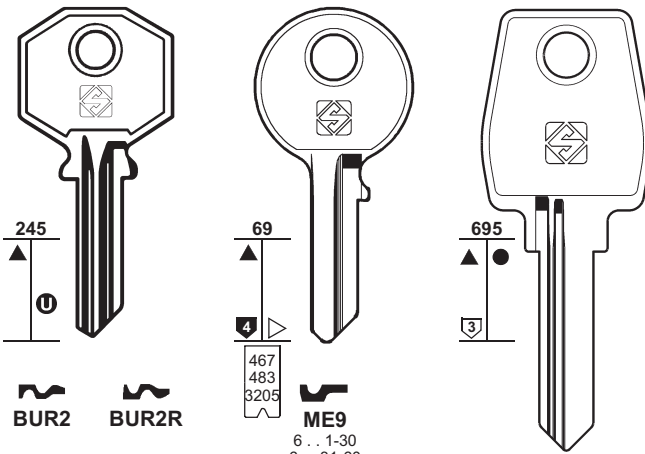

245
1

69
4

695
3

BUR2

BUR2R

467
483
3205

ME9
6 ... 1-30
6 ... 31-60
... 1234

ME10R



BURG



FARCE - KEYA
SES

MERLE

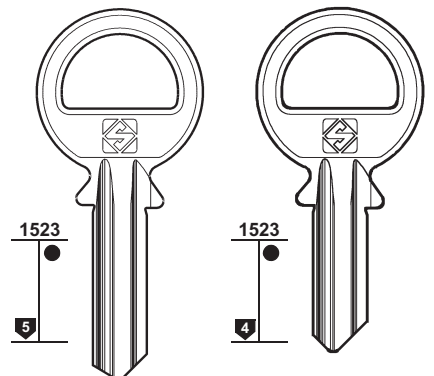

1523
5

1523
4

MLE1

MLE2

PER:
FOR:

MERONI

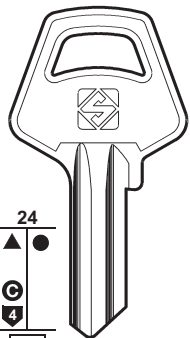

MER1

... 1001-1500

BIB - NOVOTECNICA



MER1R



LAMA

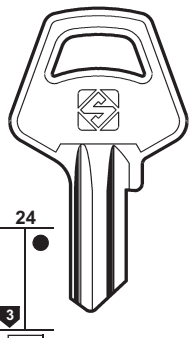

MER27

... T001-113
... 1701-1810



MER27

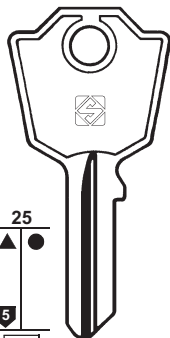

MER4

G ... 3001-3480
G ... 0-479
... 3001-3480



MER4R



LAMA

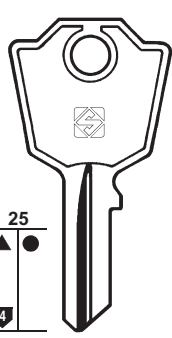

MER5

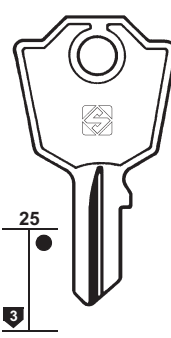

MER6



MER6R



123

PER / FOR

MERONI (I)
BIB
CAROLI
LAMA
NOVOTECNICA
+ EVERGOOD (71)

PER:
FOR:

MERONI

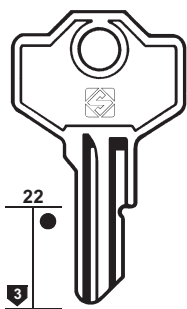

MER7R

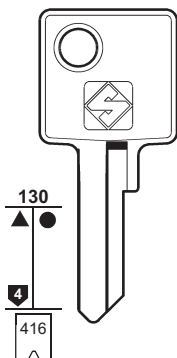

MER2

... 1-294
... 301-400
... 401-694
... 941-975



CAROLI

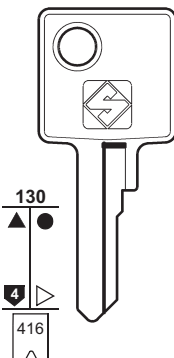

MER24

... 1-294

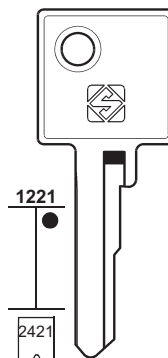

MER29

... 1-294
... 301-400
... 401-694
... 941-975

PER:
FOR:

MERONI

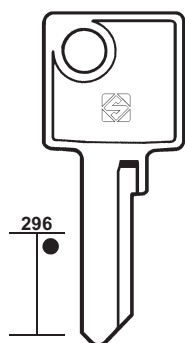

MER23
PREMI-APRI

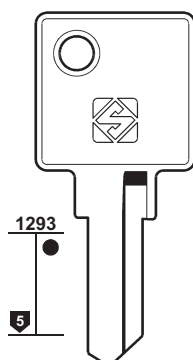

MER31

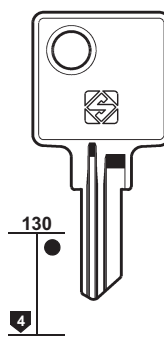

MER32



124

PER / FOR

MERONI (I)
 EBA
 IJ
 JTF
 MING-TAY
 WINFOR
 + EVERGOOD (71)

PER:
FOR:

MERONI

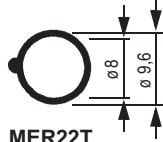
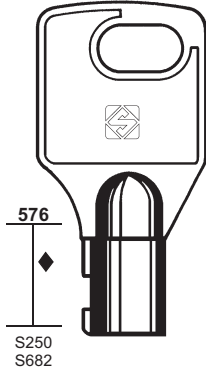

MER22T
 543210

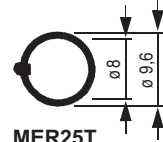
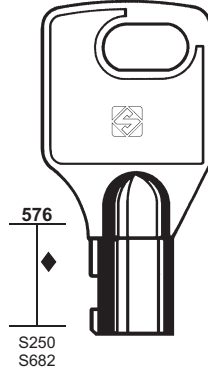

MER25T
 543210

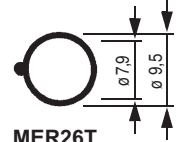
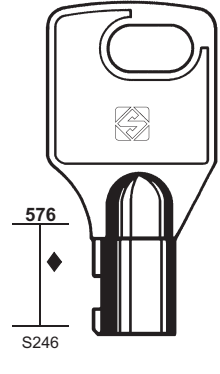

MER26T
 10000-10998



MING-TAY - WINFOR

PER:
FOR:

MERONI

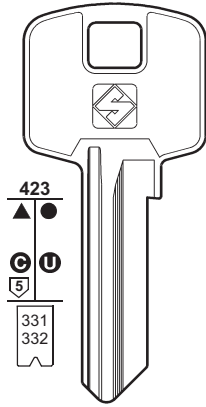

MER8

..... T
 0-1-2-3-4-5-6-7-8-9
 M.....
 0-1-2-3-4-5-6-7-8-9
 PREMI-APRI
 EBA - IJ - JTF

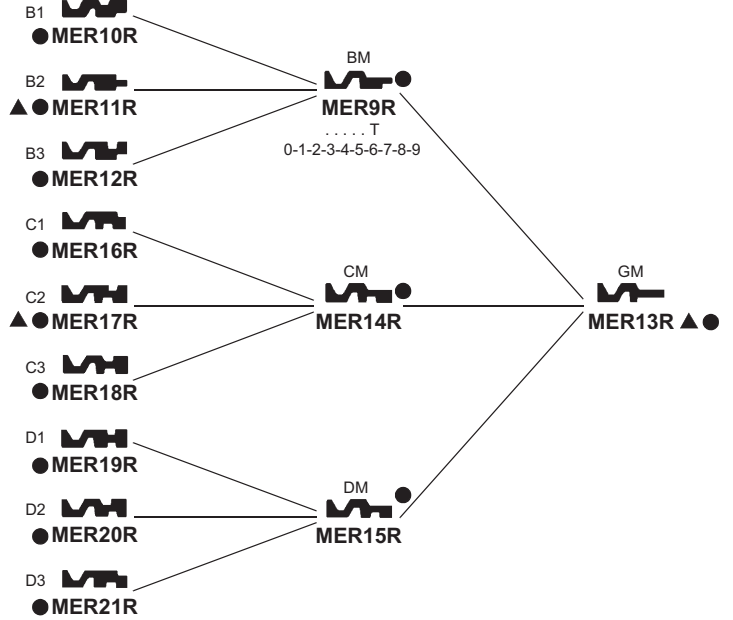

PER:
FOR:

MERONI

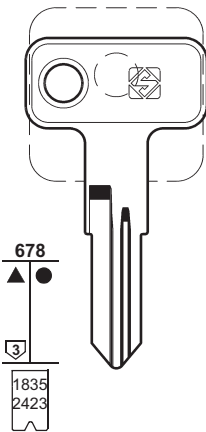

MER33R

... 0-1-2-3
 ... 1-709
 CB ... 1-709

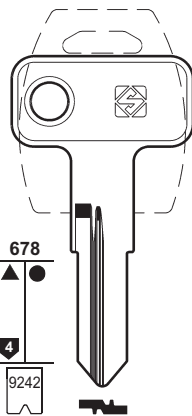

MER34R

CC 4001-4650

MER35R

CD

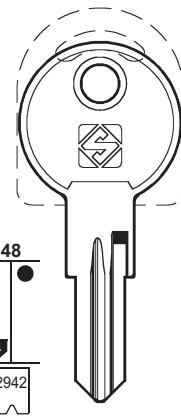

MER36

..... 1234

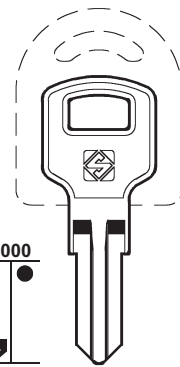



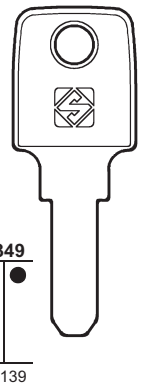





MER37

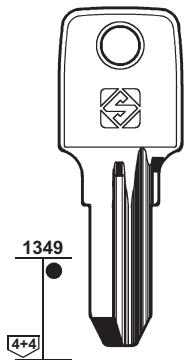

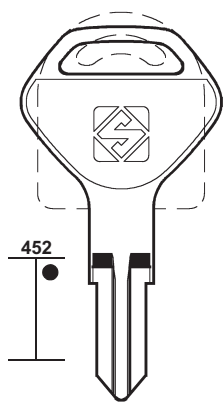
MER39

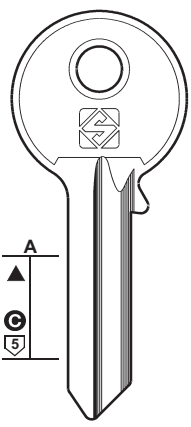
WA

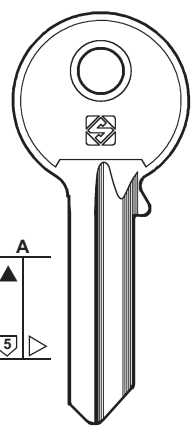



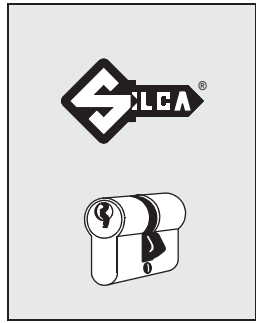





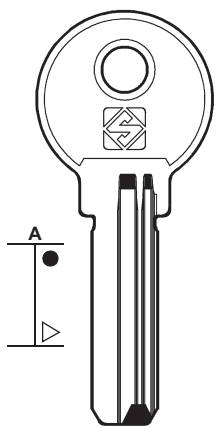

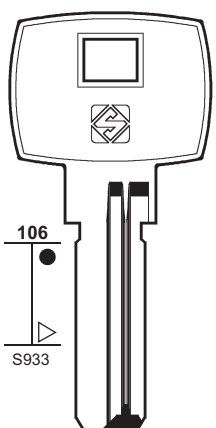

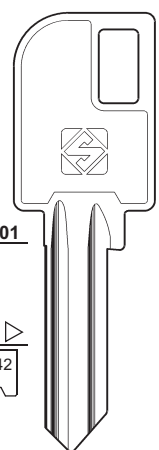

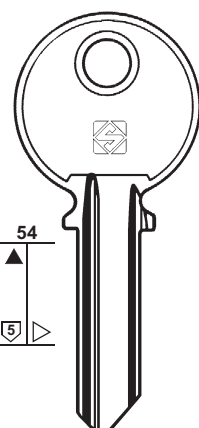



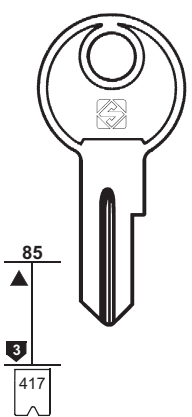

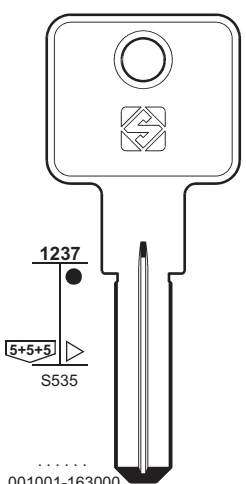

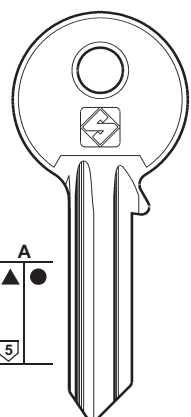
<p>PER: MERONI</p> <p>FOR:</p> <div style="display: flex; justify-content: space-around;"> <div style="text-align: center;">  <p>1349</p> <p>4+4</p>  <p>MER38</p>  </div> <div style="text-align: center;">  <p>452</p>  <p>MER41</p>  </div> </div>	<p>PER: METAL</p> <p>FOR:</p> <div style="display: flex; justify-content: space-around;"> <div style="text-align: center;">  <p>A</p>  <p>MTA1R</p>  </div> <div style="text-align: center;">  <p>A</p>  <p>MTA3R</p>  </div> </div>
--	---

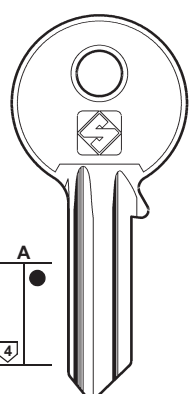

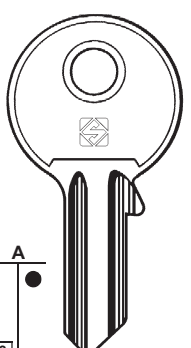
125

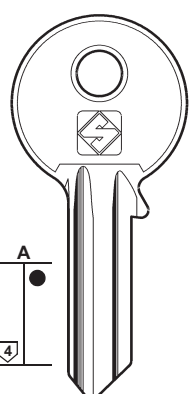
- PER / FOR**
- MERONI** (I)
 - + EVERGOOD (71)
 - METAL** (BG)
 - + OJMAR (134)
 - METALCASTELLI** (I)
 - + GIUSSANI (86)
 - + HEKNA (92)
 - + PREFER (143)
 - METALUX** (F)
 - + TESA (165)
 - + VACHETTE (181)
 - METEOR** (F)
 - + BKS (31)
 - + DOM (61)
 - + KIFERM (106)
 - METIZ** (UA)
 - + KIEV (106)
 - MG (MONTI)** (I)

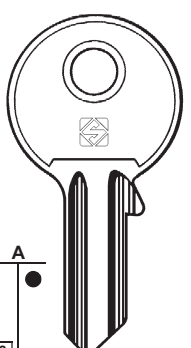
<p>PER: METAL</p> <p>FOR:</p> <div style="display: flex; justify-content: space-around;"> <div style="text-align: center;">  <p>A</p>  <p>MTA4</p>  </div> <div style="text-align: center;">  <p>106</p> <p>S933</p>  <p>MTA2</p>  </div> </div>	<p>PER: METALUX</p> <p>FOR:</p> <div style="display: flex; justify-content: space-around;"> <div style="text-align: center;">  <p>1001</p> <p>5</p> <p>442</p>  <p>MX1</p> <p>..... 1001-2178</p> <p>L..... 1001-2178</p> <p>..... 1234567</p> <p>L..... 14001-14500</p> <p>L..... 15001-18199</p> <p>..... 20001-20625</p> </div> <div style="text-align: center;">  <p>54</p> <p>5</p>  <p>MX5</p>  </div> </div>
---	---

<p>PER: METEOR</p> <p>FOR:</p> <div style="text-align: center;">  <p>85</p> <p>3</p> <p>417</p>  <p>MET1</p> <p>B... 1-600</p> <p>G... 1-600</p>  </div>	<p>PER: MG (MONTI)</p> <p>FOR:</p> <div style="display: flex; justify-content: space-around;"> <div style="text-align: center;">  <p>1237</p> <p>5+5+5</p> <p>S535</p> <p>.....</p> <p>001001-163000</p>  <p>MG8</p> <p>PBA</p>  </div> <div style="text-align: center;">  <p>A</p> <p>5</p>  <p>MG1</p> </div> <div style="text-align: center;">  <p>A</p> <p>4</p>  <p>MG1R</p> </div> <div style="text-align: center;">  <p>A</p> <p>3</p>  <p>MG2</p> </div> <div style="text-align: center;">  <p>A</p> <p>4</p>  <p>MG2R</p> </div> <div style="text-align: center;">  <p>A</p> <p>3</p>  <p>MG3</p>  </div> </div>
---	---



126

PER / FOR

MG (MONTI) (I)

MIAN-FORCE (RC)

GLOBE (87)

MIBRA (GB)

L & F (116)

MICHEL-SEAT (I)

+ **O.M.R.** (136)

+ **POTENT** (142)

+ **SEAT** (152)

MILA (DK)

+ **EVO** (72)

MILANO (BR)

MILES (RUS)

MING-TAY (RC)

SOS

+ **MERONI** (124)

MIPPART (D)

DOM (62)

MIT (I)

INDESIT (96)

PER:
FOR: **MG (MONTI)**

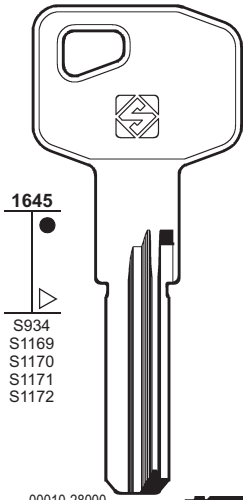

A5 00010-28000
A6 00010-28000
A7 00010-28000
A8 00010-28000

MG9
X8



MICHEL-SEAT

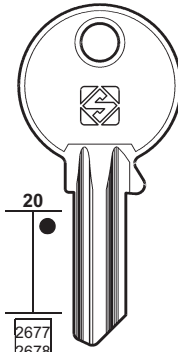

MH1
... 201-436

MH1R
... 437-672

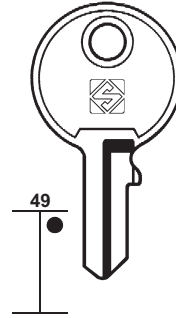

SEA4

SEA4R

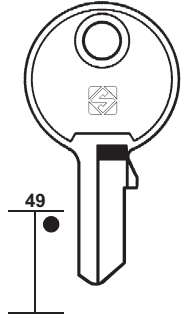

MH5R



PER:
FOR: **MILA**

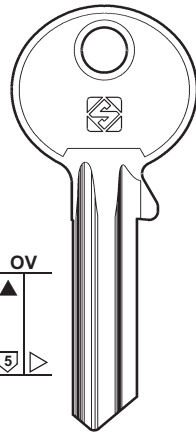

MIL1

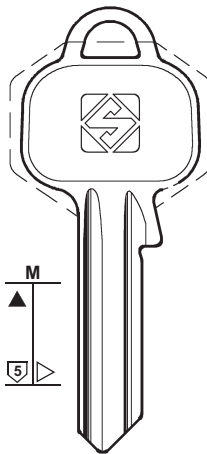

MIL2

MILANO

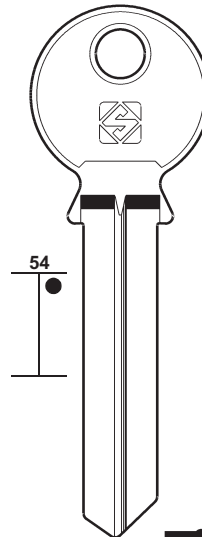

MLN3

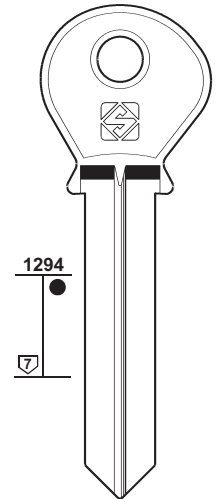

MLN1

PER:
FOR: **MILES**

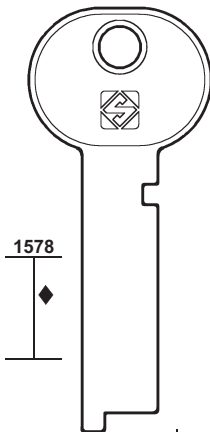

MIS1

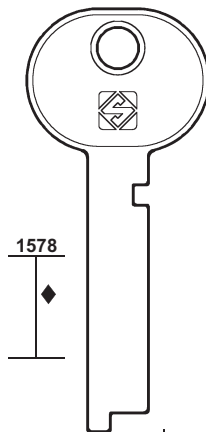

MIS2



MING-TAY

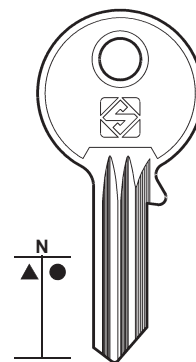

MTY1

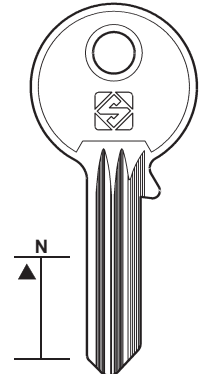

MTY2

SOS

PER:
FOR:

MIWA

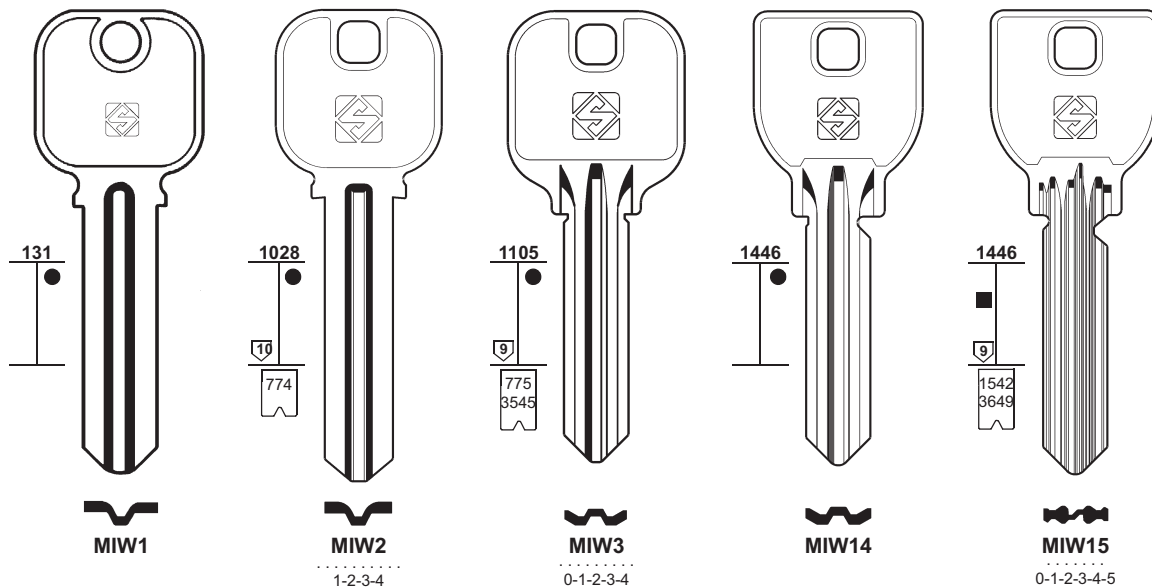

NITI LOCKS



127

PER / FOR

MIWA (J)
NITI LOCKS

MLM (D)
DOM
LEHEMANN
ORDO
STUV

- + DOM (61-62)
- + OJMAR (134)
- + RONIS (147)

MLP (I)
GIUSSANI
+ GIUSSANI (86-87)

PER:
FOR:

MIWA

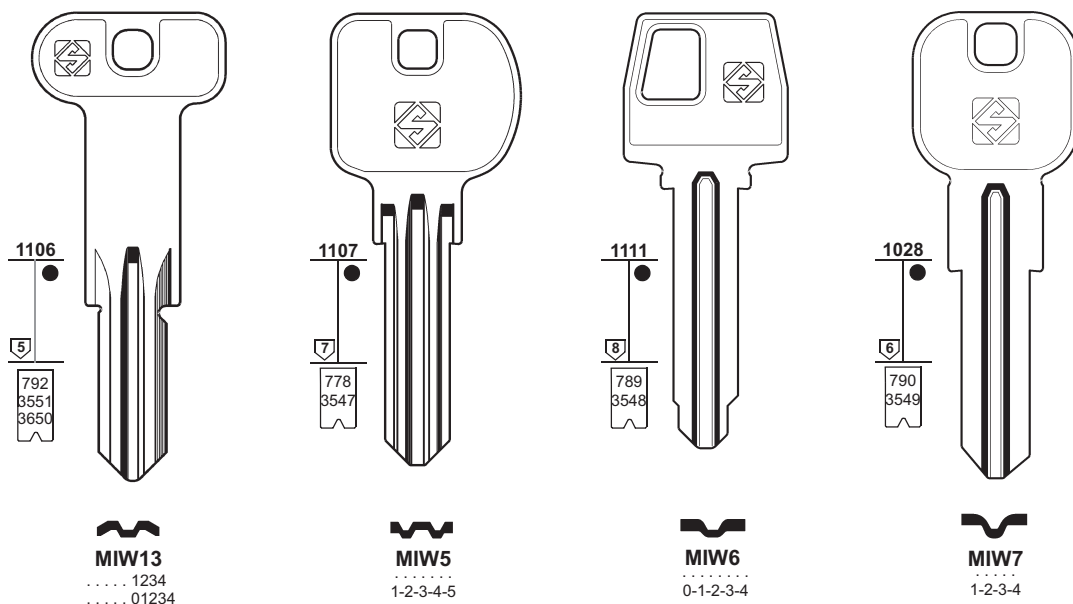

PER:
FOR:

MLM

MLP

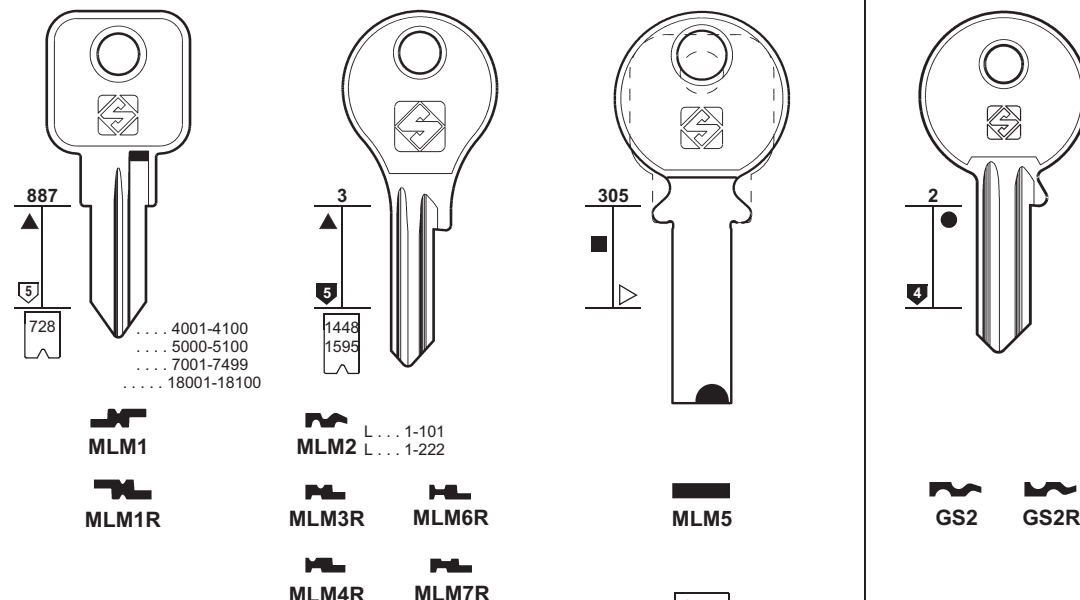

..... 4001-4100
..... 5000-5100
..... 7001-7499
..... 18001-18100

MLM1
MLM1R

MLM2 L... 1-101
L... 1-222

MLM3R **MLM6R**

MLM4R **MLM7R**



DOM - LEHEMANN - ORDO - STUV

GIUSSANI



128

PER / FOR

MOBELLA (S)

MODA (F)
PICARDIE (141)

MODERN (RC)

MODERN BAU (D)
VACHETTE (181)

MOFLEX (E)
OJMAR (134)

MON (E)

MONACOR (RC)
ALPHA (15)

MONDIAL (F)
G.R. (89)
RONIS (146)

MONDRAGON (E)
MCM (120)

MONOBLOC (F)
FO
+ ZENITH (201)

MONTI-MG (I)

MOREAUX (F)
DOM (63)
RONIS (146)
WALLY (188)



MORI E. (I)
CRISTIANI
LML
LR
TAMPALINI
ZANI
+ FIAM (79)

PER: FOR:	MOBELLA	MODERN	MON	MONOBLOC

PER: FOR:	MONTI-MG				

PER: FOR:	MONTI-MG	MORI E.			

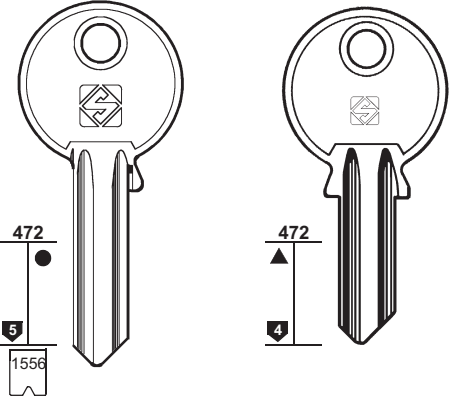
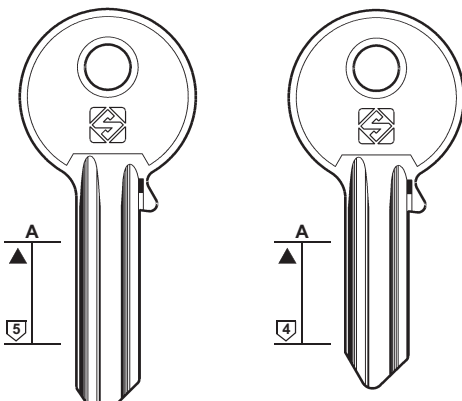

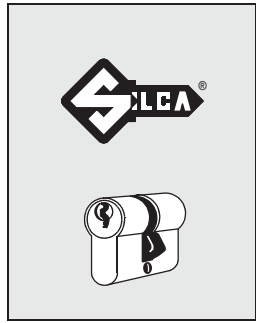

CRISTIANI - LML - LR - TAMPALINI - ZANI



PER: FOR:		MORI E.	MORI G.
		 <p>472 5 1556 1-2-3-4-5-6</p>	 <p>A 5</p>
		 <p>MI3 MI7 MI7R</p>	 <p>MIG1 MIG2</p>
		FEB	

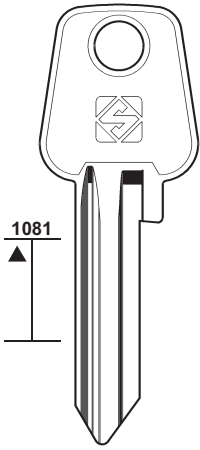
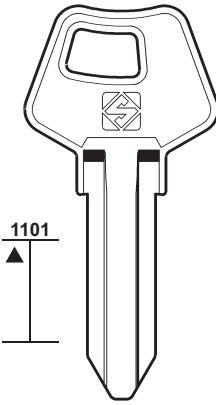
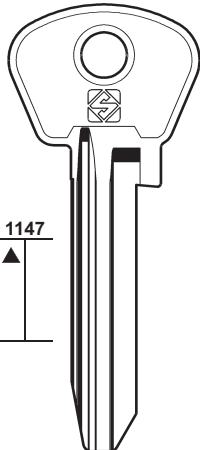

129

PER / FOR
MORI E. (I) FEB +  FIAM (79)
MORI G. (I)
MOSCON (RUS)
MOSRENTGEN (RUS)
MOTORSICH (UA)
MOTTA (BR)
MOTTURA (I)  GEVY (86)
MP-PLODARI (I)

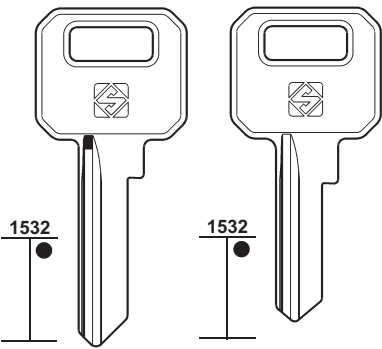
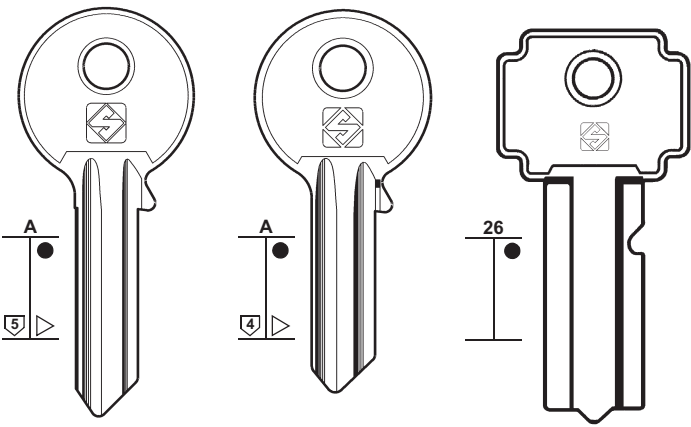
PER: FOR:	MOSCON	MOSRENTGEN	MOTORSICH
	 <p>1081</p>	 <p>1101</p>	 <p>1147</p>
	 <p>MSC1</p>	 <p>MST1</p>	 <p>MTS1 MTS1R</p>

PER: FOR:	MOTTA	MP-PLODARI
	 <p>1532</p>	 <p>A 5 4 26</p>
	 <p>MTT1R MTT2R</p>	 <p>▲ MP230 MP231 ▲ MP228 MP229 MP101</p>



130

PER / FOR

MP-PLODARI (I)

M.S.S. (P)

MST (I)
CAS-CISMA (40)

MSV (P)

MUKRA (D)
CORBIN (53)

MULT-LEI (GR)

MULT (BR)

MUL.T.LOCK (IL)
GARRISON
+ CORNI (55)

PER: **MP-PLODARI**

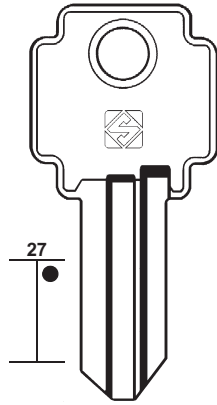

27



MP102

MP103 ▲●



MP104

MP105

PER: **M.S.S.**

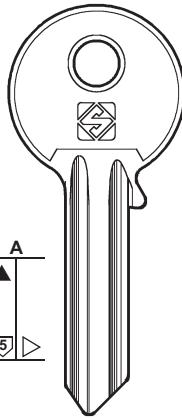

MSF1

PER: **MSV**

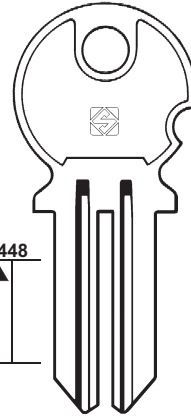

MSV1



MSV1R

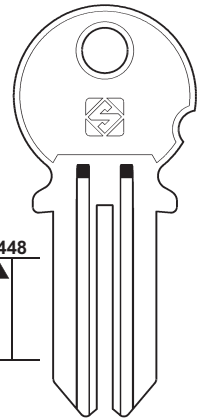

MSV2



MSV2R

PER: **MULT-LEI**

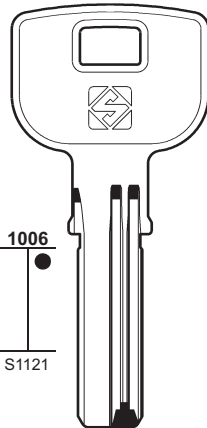

MTL1



PER: **MULT**

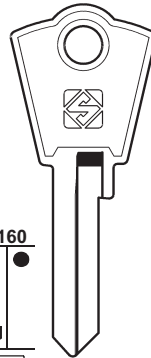

..... 1-2-3-4-5



MUL1

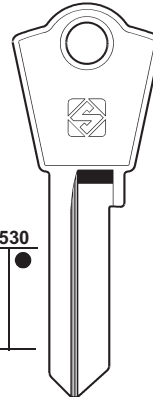

MUL2

PER: **MUL.T.LOCK**

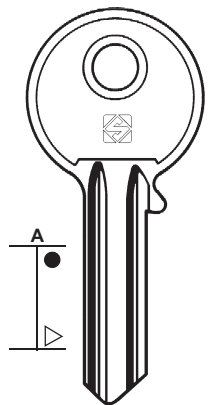

MTK5



MTK5R

PER: **MUL.T.LOCK**

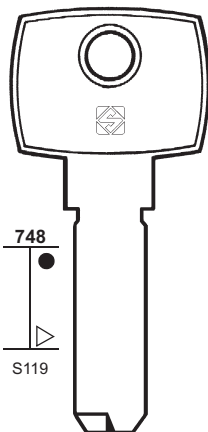

J.....
9001-9766

MTK1

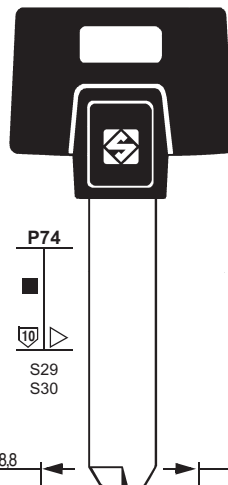

MTK2P
(006)

ABCD-12345



MTK3P
(006)

ABCD-12345-01

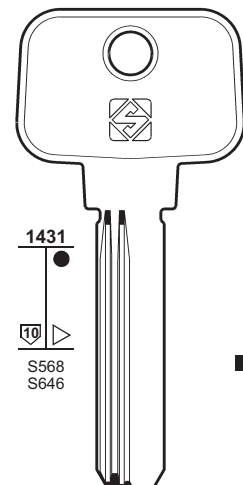

MTK11R
06



GARRISON

MTK15R
66

MTK16
11

MTK12R
08
(008)
ABCD-12345

MTK13R
77

PER:
FOR:

MUL.T.LOCK



131

PER / FOR

MUL.T.LOCK (IL)
GARRISON
SP

+ CORNI (55)

NABOB (IL)

NAIKI (J)

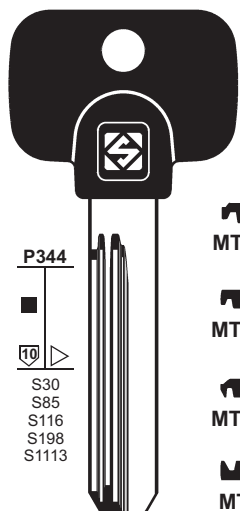

MTK9RP

P344



S30
S85
S116
S198
S1113

(006)
MTK8RP ABCD-12345-01
64

(006)
MTK7RP ABCD-12345-01
50

(005)
MTK4P ABCD-12345
05

(006)
ABCD-12345-01 **MTK10RP**



SP

(006)
MTK4RP ABCD-12345-01
06

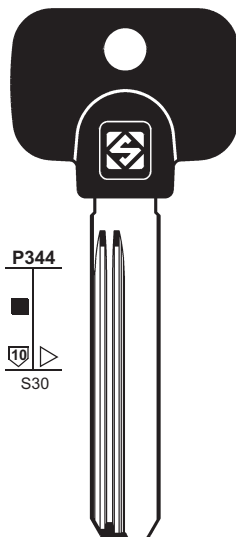

MTK4RPX
06

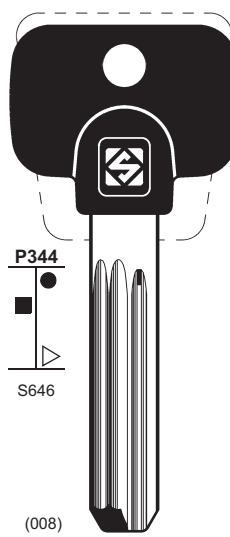

P344



S646

(008)
ABCD-12345

MTK12RP
08



PER:
FOR:

MUL.T.LOCK

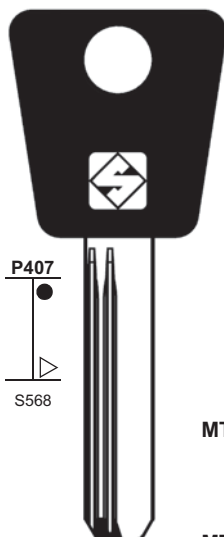

P407



S568

MTK15RAP
66

MTK13RAP
77



GARRISON

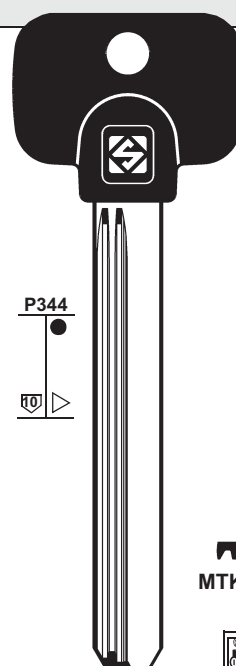

P344



MTK14RP



PER:
FOR:

NABOB

NAIKI

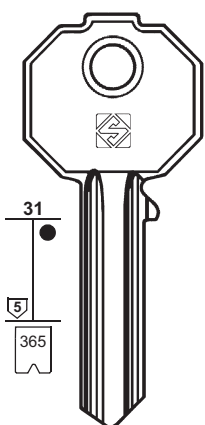

31



365

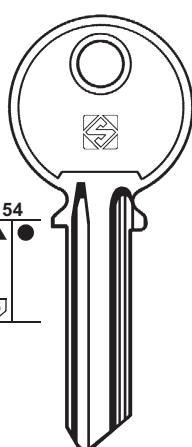

54



372

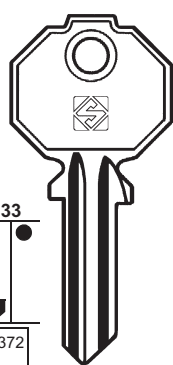

33



372

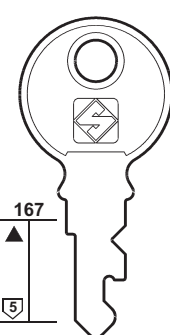

167



1640

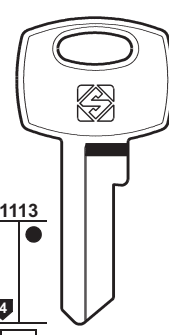

1113



1640

NAB1

NAB1R

NAB2

NAB3R

NAB4

NR1R

NK1

NK2

0-1-2-3-4-5-6-7-8

0-1-2-3-4-5-6

NAB5

NAB6

H...
1-960

E...
1-960

NK3

J...
1-960





132

PER / FOR

NATIONAL CABINET (USA)
 NATIONAL CASH REGISTER
 NATIONAL ROCKFORD

NATIONAL CASH REGISTER (USA)
 NATIONAL CABINET (132)

NATIONAL LOCK HARDWARE (USA)
 NATIONAL ROCKFORD (132)

NATIONAL ROCKFORD (USA)
 NATIONAL LOCK HARDWARE
 + NATIONAL CABINET (132)

NAZABAL (E)
 EZCURRA (73)

NB (D)
 CISA (48)
 FLORA (81)

NEC (J)

NELFA (DK)

NEMEF (NL)
 + CES (41-42-43)
 + CORBIN (53)
 + RONIS (147)

NEPTUNE (GB)

NICO (D)
 FTH (81)
 KFV (105)

NINO (E)
 TESA (165)

NITI LOCKS (J)
 MIWA (127)

NOBO (N)
 DOM (60-61-63)
 VING (186)

NONES (I)

NONFANGO (I)

PER:
FOR:

NATIONAL CABINET

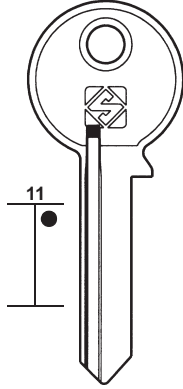

11

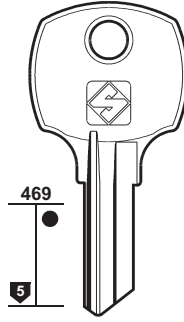

469

5

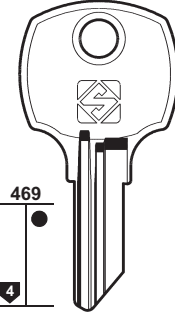

469

4

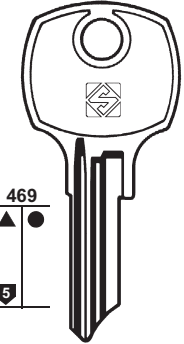

469

5

NCR6

NCR12 NCR13

NCR3

NCR1 NCR1R

NCR11R NCR19



NATIONAL CASH REGISTER



NATIONAL ROCKFORD

PER:
FOR:

NATIONAL ROCKFORD

NEC

NELFA

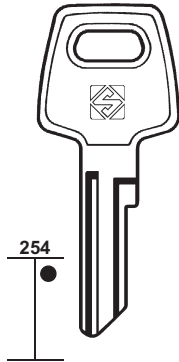

254

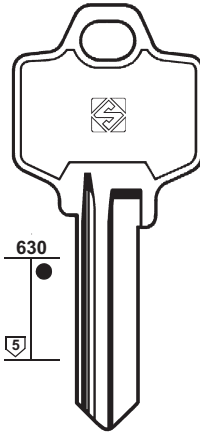

630

5

NCR2

NCR4



NATIONAL LOCK HARDWARE

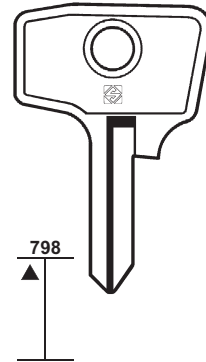

798

NEC1

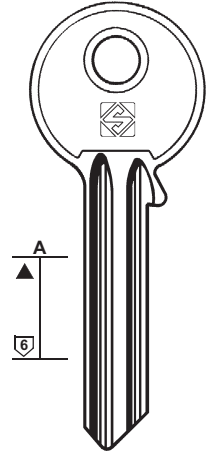

A

6

NF1 NF1R

PER:
FOR:

NEMEF

NEPTUNE

NONES

NONFANGO

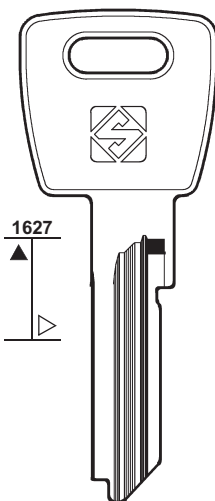

1627

NME1R

NME2R
NF1

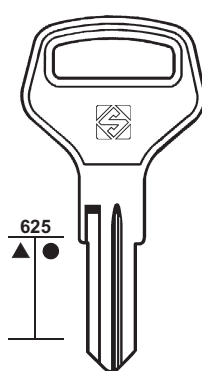

625

NP1R

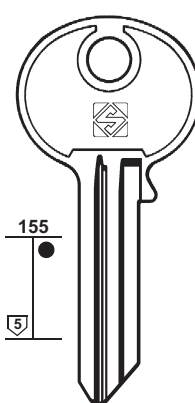

155

NN1

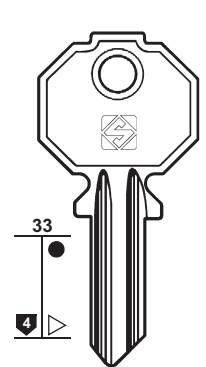

33

PF12



PER: **NONFANGO**
FOR:

OAL

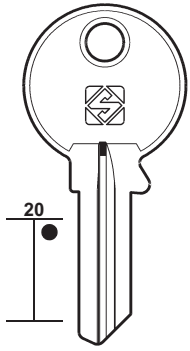

PT1 PT1R

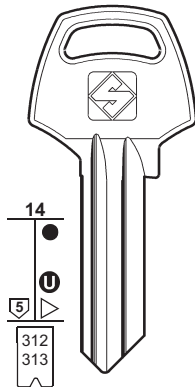

CB1 CB1R
..... 2-3-4-5-6-7-8-9
..... 1-2-3-4-5-6-7-8-9

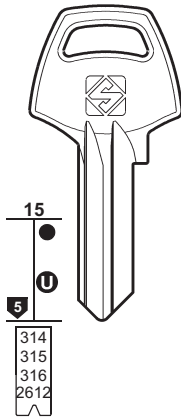

CB3
..... 1-2-3-4-5-6-7-8-9
..... 2-3-4-5-6-7
..... 1-2-3-4-5-6-7-8

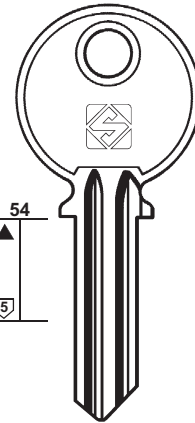

OAL4



133

PER / FOR
NONFANGO (I)

NORDWEST (D)
👁️ FLORA (81)
👁️ SCHLECHTENDAHL (152)

NOVA (D)
👁️ TOP (171)
👁️ YETI (199)

NOVOFERM (I)
👁️ CORBIN (53)

NOVOTECNICA (I)
👁️ MERONI (123)

NUMIDIA (E)
👁️ ESA (69)
👁️ RONIS (146)

OAL (I)
CORBIN
+ 👁️ CORBIN (52)
+ 👁️ GIUSSANI (86)

OB (I)
👁️ ZANETTI A. (200)

OBEL-ODARIA (J)

ODA (NL)
👁️ ANKERSLOT (16)
👁️ CHICAGO (45)

OFFERMANS-FLOOD (RCH)

OJMAR (E)
+ 👁️ CES (41-42)
+ 👁️ HR (93)

PER: **OAL**
FOR:

OBEL-ODARIA

OFFERMANS-FLOOD

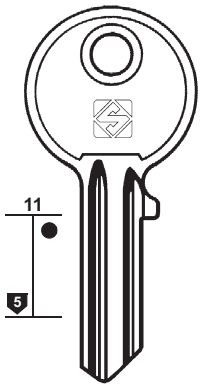

OAL3

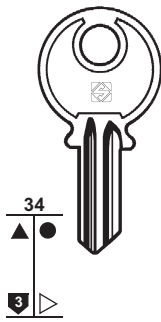

OAL1 OAL1R

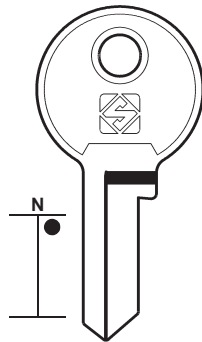

OB1

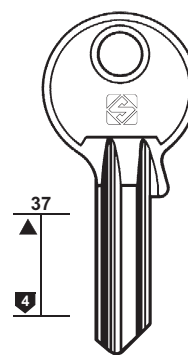

OF4



PER: **OJMAR**
FOR:

OJMAR

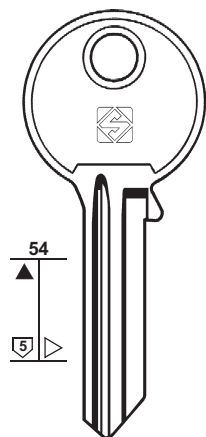

OJ2

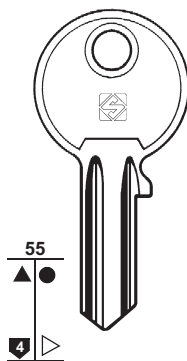

OJ1 OJ1R

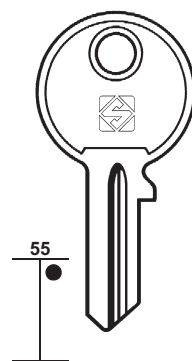

OJ3R

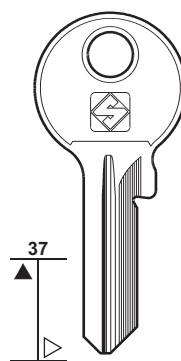

OJ4 OJ4R

OJ16R

J

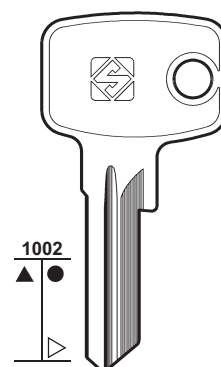

OJ5R



134

PER / FOR

OJMAR (E)

BURG
METAL
MLM
MOFLEX
SISO
STUMPF
+ CES (42)
+ HR (93)

OLIVA (I)

FERMABLOCK
PB
PREFER

OLIVETTI (I)

CASIO
 GIOBERT (86)

PER:
FOR:

OJMAR

A1 ... 1-698
S ... 1-698
..... 680
S 680

A ... 1-698
S ... 1-698
U ... 1-698
..... 680

F 680 F1

U 680

BURG - METAL - MOFLEX
SISO - STUMPF

BURG - MLM

..... 0-1-2

5-Q4

PER:
FOR:

OLIVA

OLIVETTI

A

A

616

616

4

OL5R

OL5

▲ OL4

OL6

OLT1

OLT2

FERMABLOCK - PB - PREFER

PER:
FOR:

OLIVETTI

616

616

616

616

OLT4

OLT5

OLT6R
X

OLT8R
P

CASIO

CASIO

CASIO

CASIO

PER:
FOR:

OLIVETTI

616
616

OLT7
X
OLT3

OMA

54
A
A

6
5
4

▲ OA1
OA1R
OA2
OA2R ●
OA3R ●

C.A.R.S.
C.A.R.S.

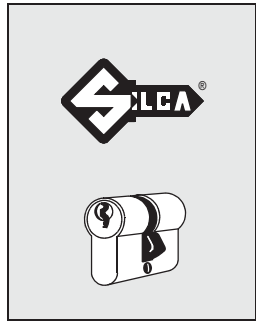

135

PER / FOR

OLIVETTI (I)
GIOBERT (86)

O.M.A. (I)
C.A.R.S.

OMEC (I)
SANTOS

PER:
FOR:

OMEC

1369
29
29
29
29

5
5
4
3
4

3688
3688
3688
333
334

OC5
.....
123456789
OC238
OC239 ●
OC236
OC237 ●
OC2
OC1
..... 1-2-3-4-5

PER:
FOR:

OMEC

29
1339
1339
1339

5
6
6
6

333
S661
S711
S710

334
S1053
S711
S710

⊕ **OC074**
OC075 ●
OC3
OC4
OC6

..... 1-2-3-4-5
AB
0000001-0046656
BA
0000001-0046656



136

PER / FOR

OMIV (I)

CIB
STV
+ BIELLE (30)

O.M.R. (I)

MICHEL-SEAT
+ POTENT (142)
+ PREFER (143)

ONIUN (RC)

UNION (176)

ORBA (D)

SIMECA (155)

ORDO (F)

+ KIFERM (106)
+ LAS (111)
+ MLM (127)

ORION NOVOX (F)

DECAYEUX

ORLANDO (I)

ICSA (94)

ORO (IL)

ORSA (BY)

OSKO (D)

JOWIL (100)

OT (I)

FONDAR (81)

OTHMER (D)

ABUS (6)

OTIS (I)

CES (42)
 ILLINOIS (96)
 ZEISS-IKON (200)

OTTO (I)

BURG (37)

PER:
FOR:

OMIV

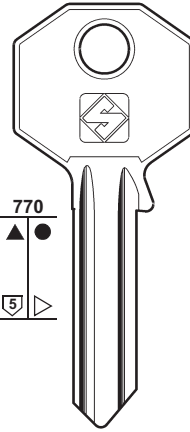
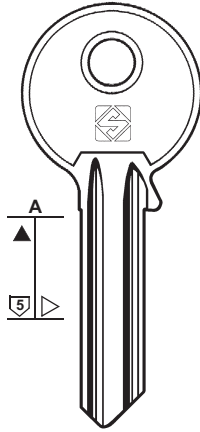
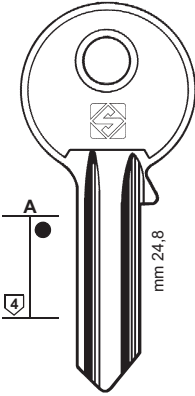

OV1



OV1R



OV2



OV2R



OV3



OV3R

CIB - STV

CIB - STV

O.M.R.

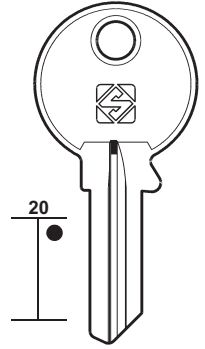
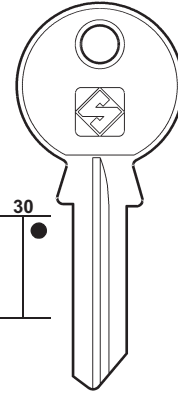

MH2



MH2R



PT1



PT1R

MICHEL-SEAT

PER:
FOR:

O.M.R.

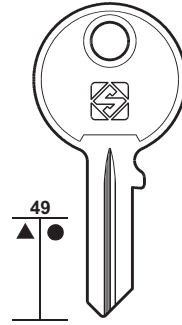
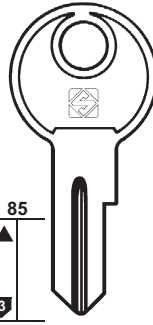
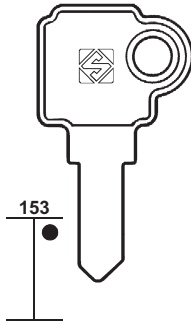

SEA5



SEA5R



MET1

B... 1-600
G... 1-600



OMR1R



SEA7



SEA8



MICHEL-SEAT



MICHEL-SEAT

ORDO

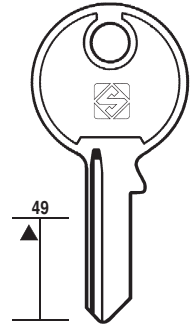

OR1R



PER:
FOR:

ORION NOVOX

ORO

ORSA

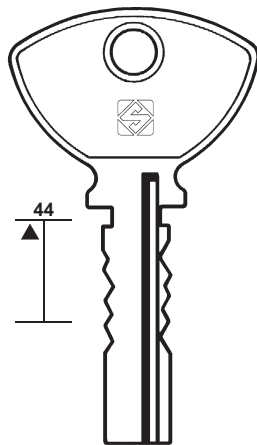

ON1



ON1R

DECAYEUX

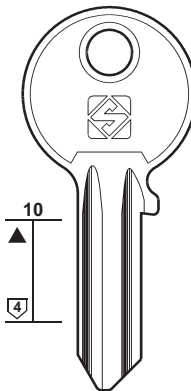

ORO1



ORO2

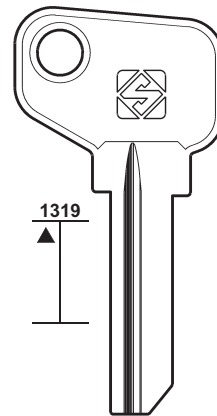

ORA1

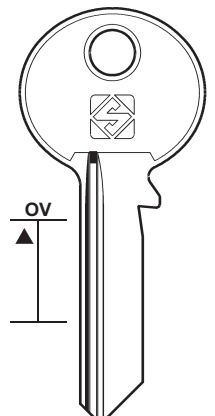

ORA2

PER:
FOR:

PACRI

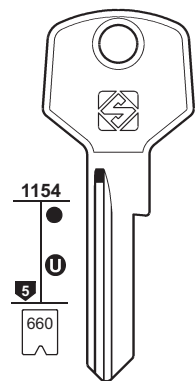

..... 1-2-3-4-5-6-7



PAC1R

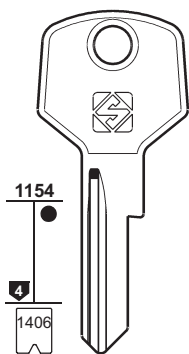

..... 1-2-3-4



PAC2R

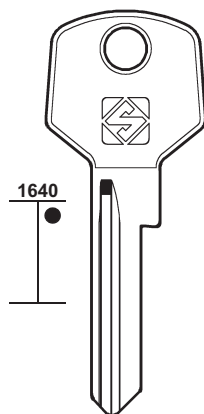

PAC3R

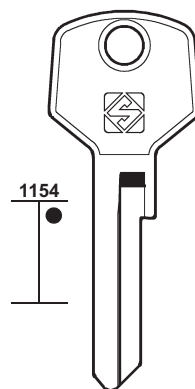

PAC4



137

PER / FOR

PACRI (BR)

PADO (BR)

PER:
FOR:

PADO

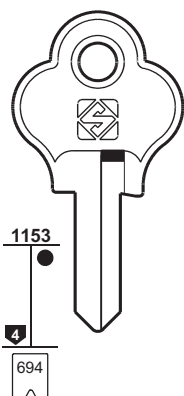

..... 1-2-3



PDO12



PDO12R

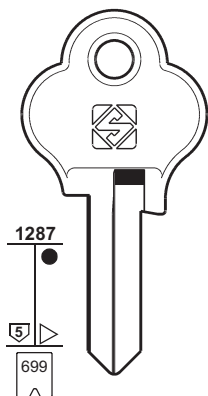

..... 1-2-3-4-5



PDO17



PDO17R

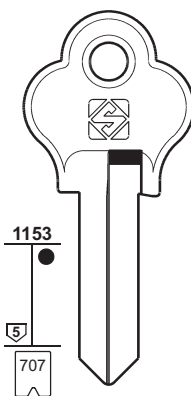

..... 1-2-3-4-5-6



PDO2

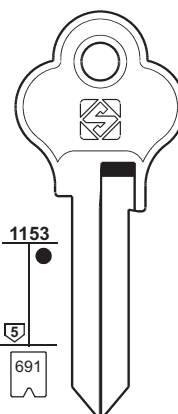

..... 1-2-3-4-5



PDO9



PDO9R

PER:
FOR:

PADO

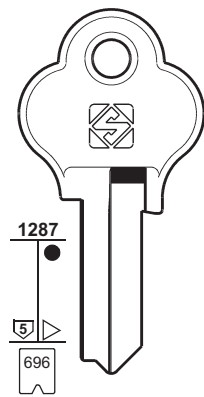

..... 1-2-3-4-5



PDO14



PDO14R

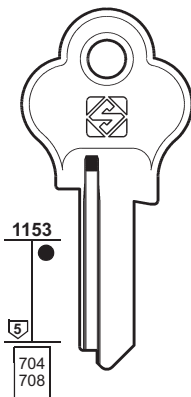

..... 1-2-3-4-5



PDO1R



PDO1R

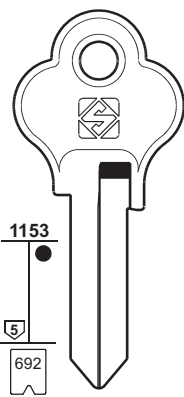

..... 1-2-3-4-5



PDO10R



PDO10R

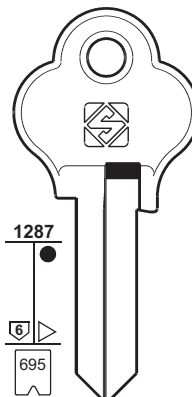

..... 1-2-3-4-5-6



PDO13



PDO13R

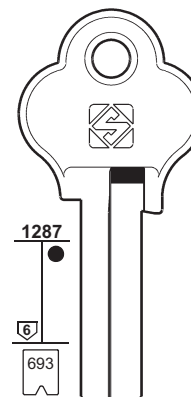

..... 1-2-3-4-5



PDO11



PDO11



138

PER / FOR

PADO (BR)

PANDA (F) (RC)

PANTHER (D)
JOWIL (100)

PAPAIZ (BR)

PER:
FOR:

PADO

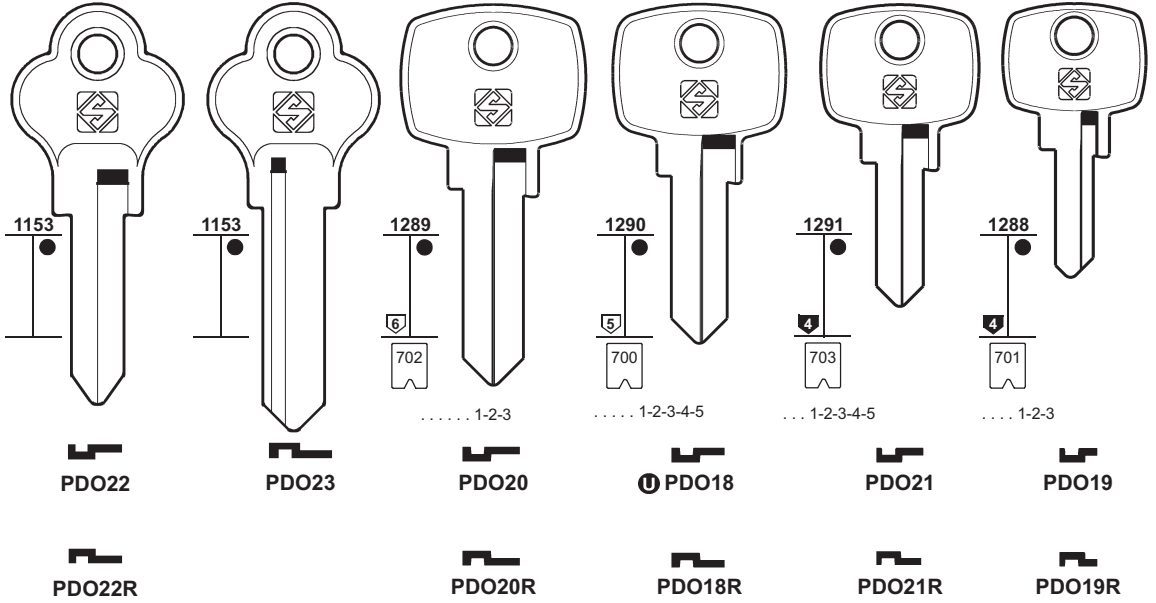

PER:
FOR:

PANDA

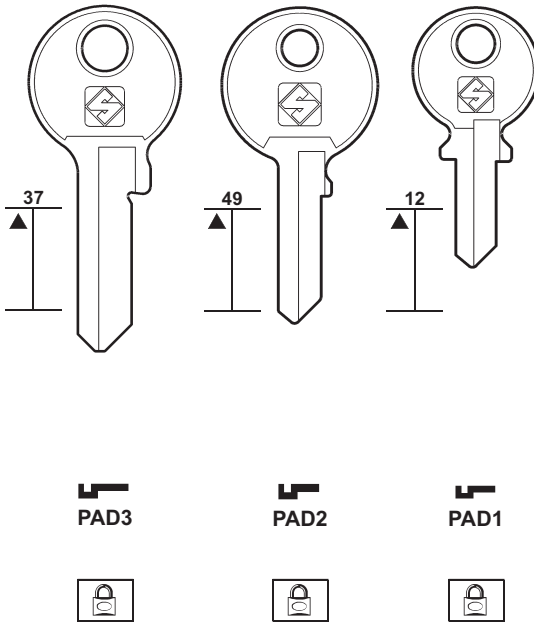

PAPAIZ

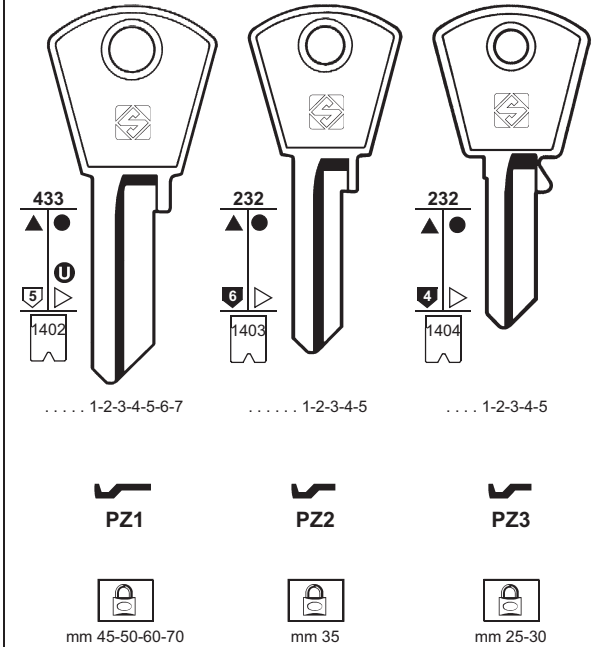

PER:
FOR:

PAPAIZ

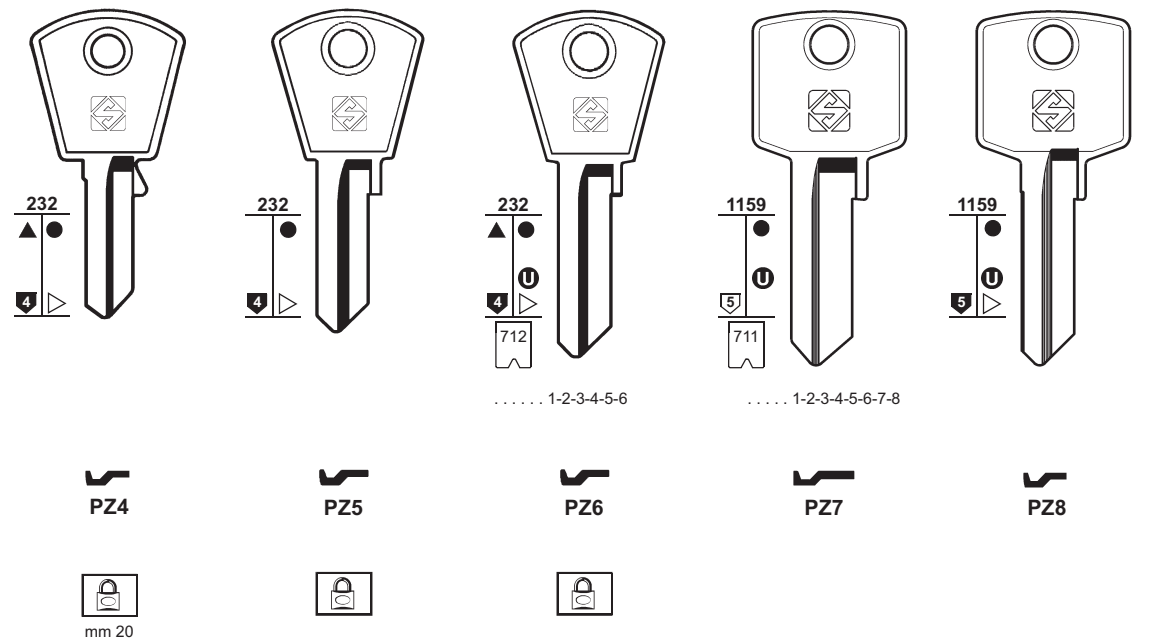

PER:
FOR:

PAPAIZ

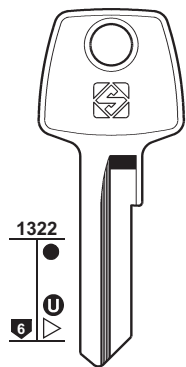

PZ9

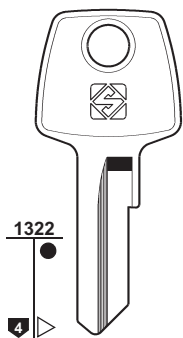

PZ14

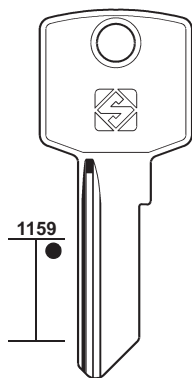

PZ18R

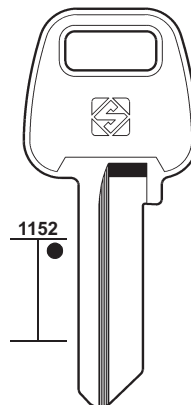

PZ17



139

PER / FOR

PAPAIZ (BR)

PARMA (I)

PAS (I)

👁️ PREFER (143)

PASSY (F)

👁️ RICOUARD (146)

PASTORE (I)

👁️ GIUSSANI (87)

👁️ PREFER (142)

P.B. (I)

👁️ OLIVA (134)

P.C. (CORTELLEZZI) (I)

ETNA

FEB

FPB

FRAL

LUNA

PLODARI

SANTOS

SAVIO

+ 👁️ BIELLE (30)

+ 👁️ JVAL (102)

PER:
FOR:

PAPAIZ

PARMA

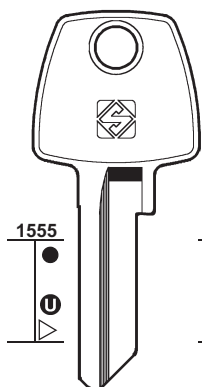

PZ15

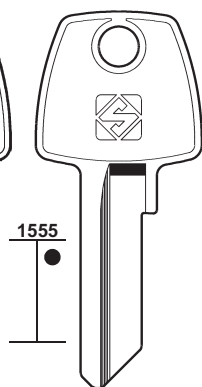

PZ19

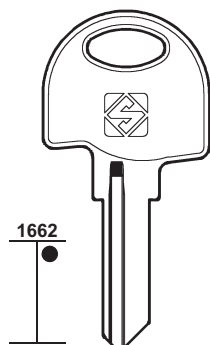

PZ20R

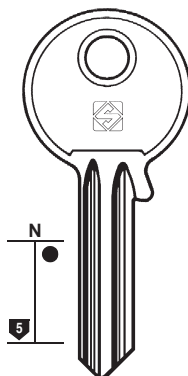

PA2



▲PA2R

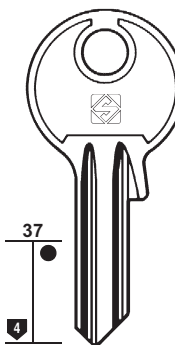

PA1



PA1R

PER:
FOR:

P.C. (CORTELLEZZI)

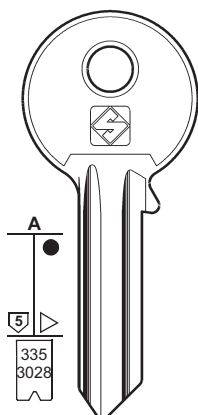

PC14

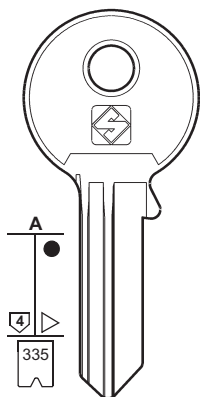

PC20



PC18R ▲●

... 1-2-3-4-5



PC4



PC4R

... 1-2-3-4-5

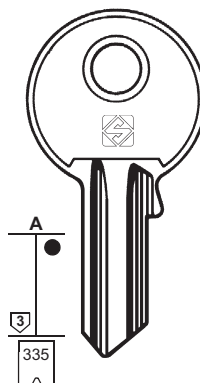

PC10



PC10R ▲●

... 1-2-3-4-5

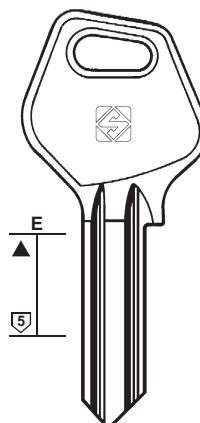

PC13



▲●PC1

... 1-2-3-4-5

... 1-2-3-4-5-6-7



PC1R

ETNA - FEB - FPB
FRAL - SANTOS - SAVIO

ETNA - FEB
FPB - LUNA - PLODARI



140

PER / FOR

P.C. (CORTELLEZZI) (I)

CASMA
FEB
GEVY
JVAL
R.S.M.
SILCA
SUL

+ BIELLE (30)
+ JVAL (102)

PENZA (RUS)

PERINO PG (I)
IMSI

PEROHAUS (F)

DOM (61)
 GEGE (84-85)
 JUNIE (101)

PERRIER (F)

G.R. (90)

PETERBORO (USA)

DOMINION (66)

PER:
FOR:

P.C. (CORTELLEZZI)

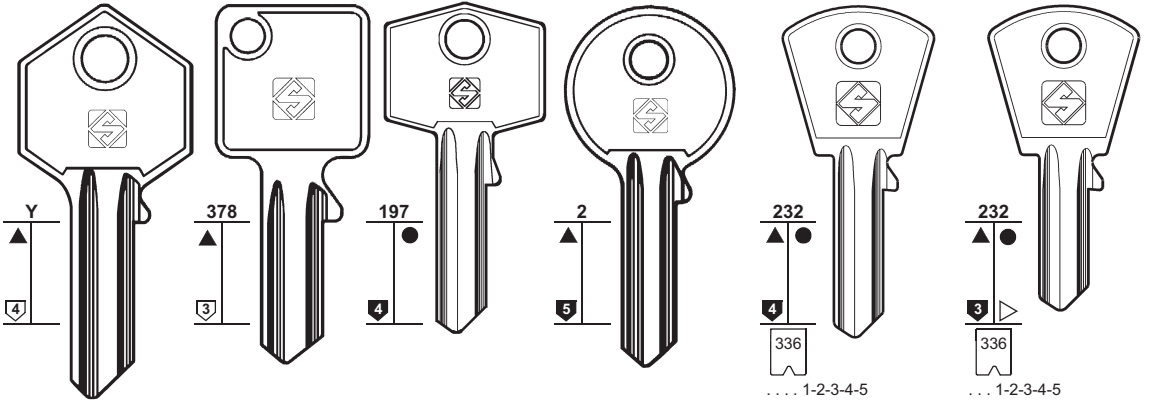

PC11

PC5

PC6

PC8

PC2

PC3

● PC2R

GEVY - R.S.M.

JVAL - SUL

CASMA



PER:
FOR:

P.C. (CORTELLEZZI)

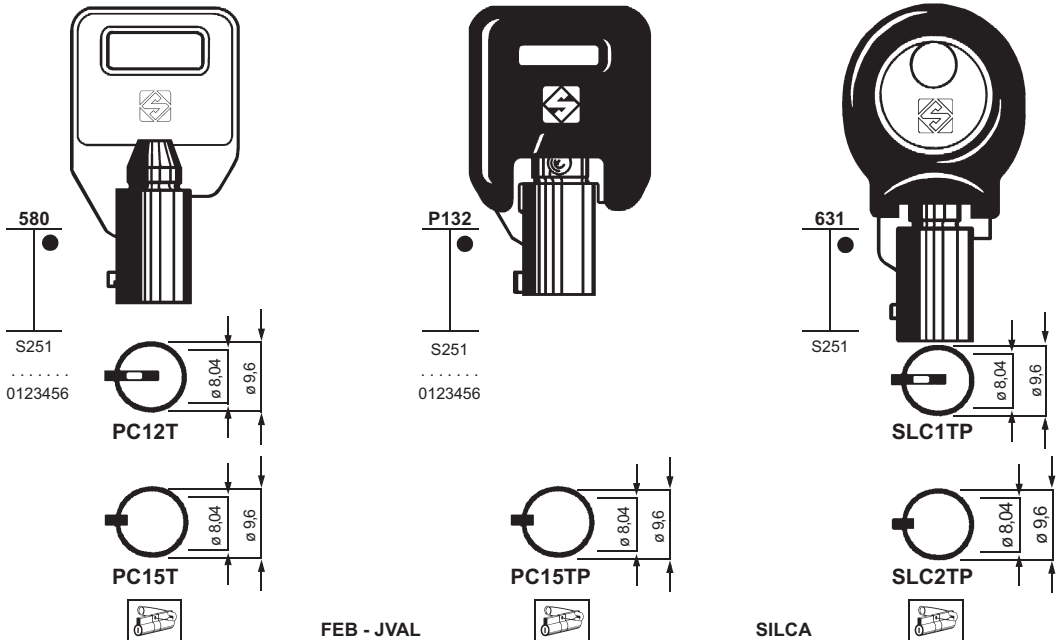

PC12T

PC15T

PC15TP

SLC1TP

SLC2TP

FEB - JVAL

SILCA

PER:
FOR:

PENZA

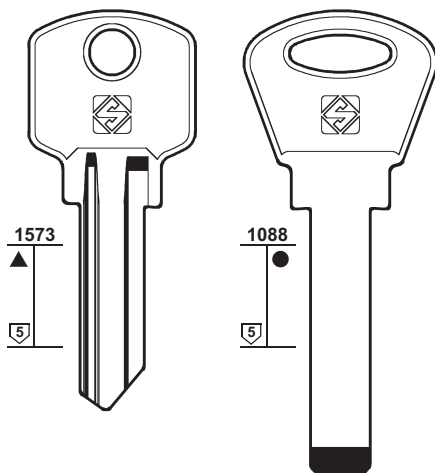

BZ2

BZ2R

BZ3



IMSI

PERINO PG

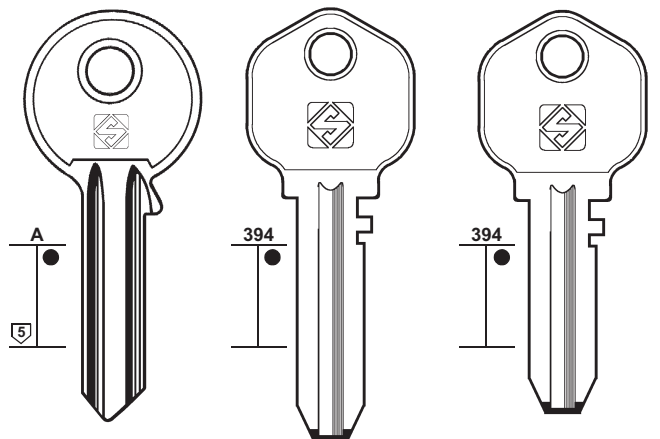

▲ PG1

PG1R

PN1

PN2



IMSI



PER: **PETROZAVODSK**
FOR:

PFAFFENHAIN



141

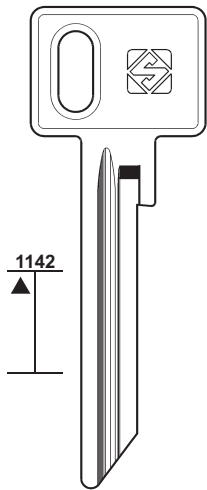

1142

PTZ1R

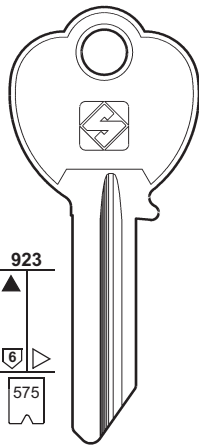

923

6
575
..... X-Y-0-1-2-3-4-5-6-7-8-9
..... 25080-58049

PHF1R
HK

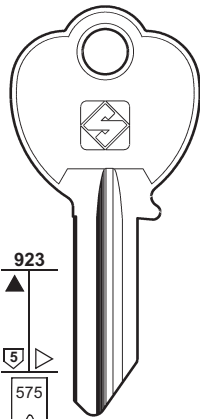

923

5
575
..... 0-1-2-3-4-5-6-7-8-9
..... 1-57036

PHF2R
L



ABUS

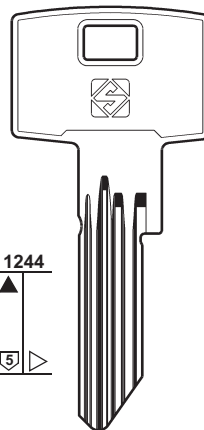

1244

PHF5

PHF6

PHF4R

PHF7R

PHF8R

PHF9R

PHF10R

PHF11R

PHF12

PHF15

PER: **PFAFFENHAIN**
FOR:

PICARDIE

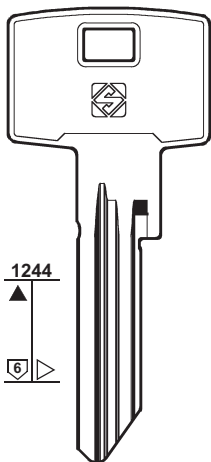

1244

PHF16R
SRA
BUVA

PHF23
PHF22R
PHF19
EA
PHF18R
FD
PHF17
ED

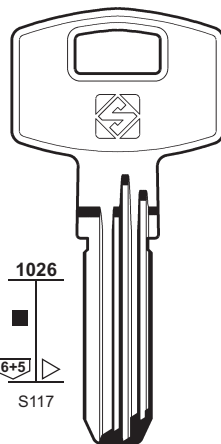

1026

6+5
S117

PIC1

DECAYEUX - MODA
S & E - STS

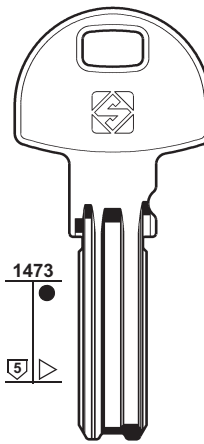

1473

5

PIC2



PER: **POLI**
FOR:

POS

POTENT

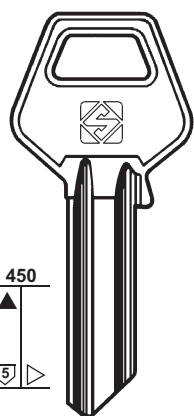

450

PL1

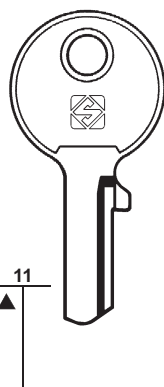

11

PS1
CZ

SIGENIA

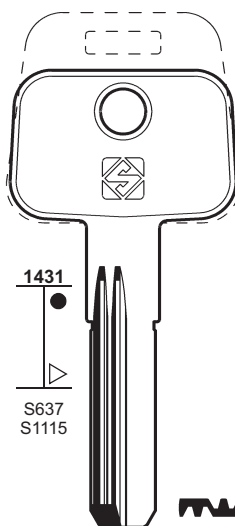

1431

S637
S1115

PT4R

..... 1-2-3-4-5

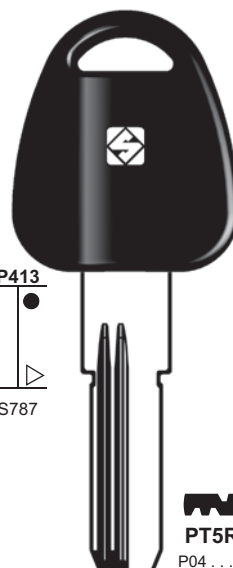

P413

S787

PT5RP

P04
1-2-3-4-5-6



PER / FOR

PETROZAVODSK
(RUS)

PFAFFENHAIN (D)
ABUS
BUVA

PICARD (F)
BETA (29)
KABA (102)

PICARDIE (F)
DECAYEUX
MODA
S & E
STS
+ AMARO LIMITADA (15)
+ FTH (81)
+ GABON (84)
+ SIS (156)
+ TITAN (167)

P.J. (F)
RONIS (147)

P.K. (F)
LAS (110)

PLG (I)
GIUSSANI (86)

PLODARI (I)
P.C. (139)

PM (F)
RONIS (146-147)

POLI (RCH)

POPLOCK (I)
CORBIN (52-53)

POS (D)
SIGENIA

POTENT (I)
MICHEL (126)



142

PER / FOR

POTENT (I)

AM
MICHEL
NONFANGO
O.M.R.

+ MICHEL (126)

PREFER (I)

BLOCUS
CAP
CIB
FATTORINI
JIP
PASTORE
PROMO
UNIFOR

+ OLIVA (134)

+ TRAU (172)

PER:
FOR:

POTENT

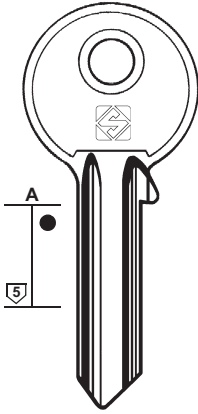

PT2

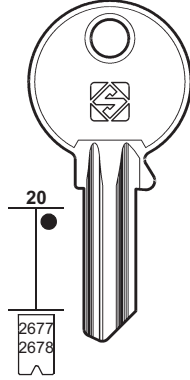

MH1
... 201-436



MH1R
... 437-672



MICHEL

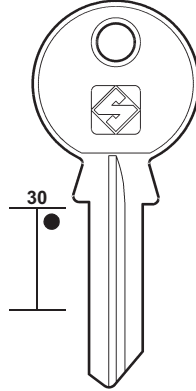

MH2



MH2R

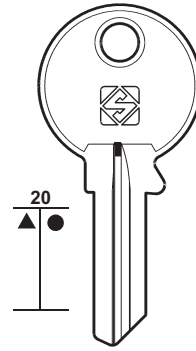

PT1



PT1R



AM
MICHEL
NONFANGO

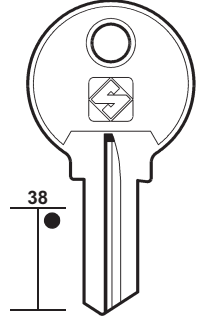

MH4



MH4R



MICHEL
O.M.R.

PER:
FOR:

PREFER

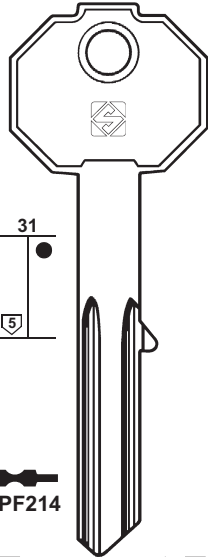

PF214



PF215

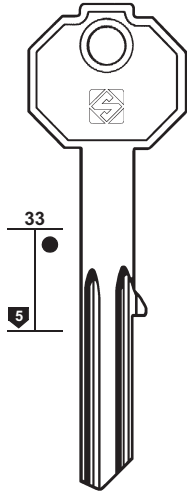

PF215R

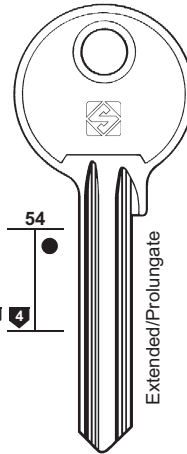

PF3



PF3R



PF11



PF11R

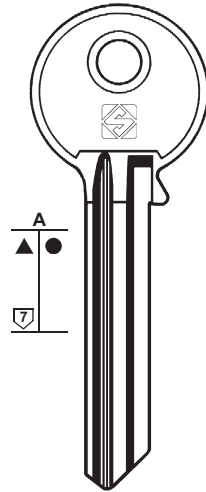

PF7



PF7S

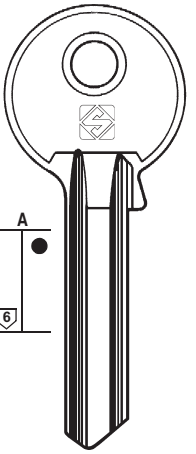

PF8



PF8R

PER:
FOR:

PREFER

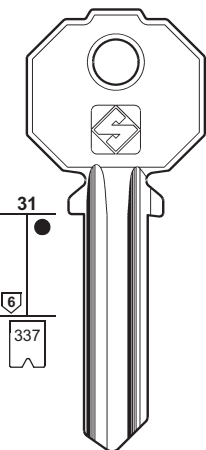

PF6



PF6R
... 1-2-3-4-5

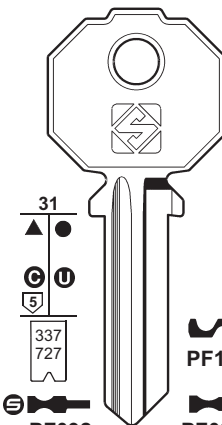

PF92
... 1-2-3-4-5



PF16R



PF92S
... 1-2-3-4-5

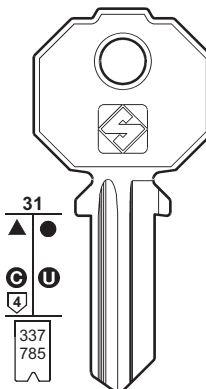

PF2
... 1-2-3-4-5



PF2S
... 1-2-3-4-5

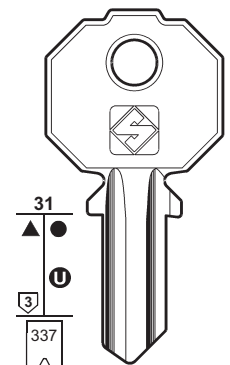

PF5



PF5S
... 1-2-3-4-5



PF210
... 1-2-3-4-5



PF211
... 1-2-3-4-5



PF212
... 1-2-3-4-5



PF213
... 1-2-3-4-5



PF208
... 1-2-3-4-5



PF209
... 1-2-3-4-5



BLOCUS - CAP - CIB - JIP
PASTORE - PROMO



BLOCUS - CAP - CIB
FATTORINI - PASTORE - PROMO



UNIFOR

PER:
FOR:

PREFER

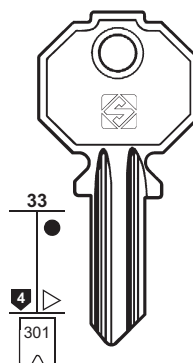
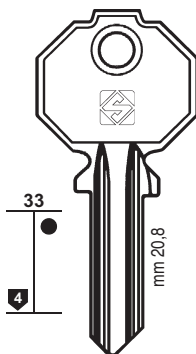
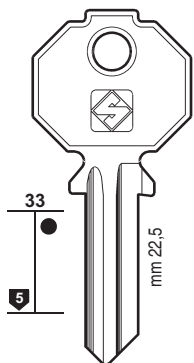
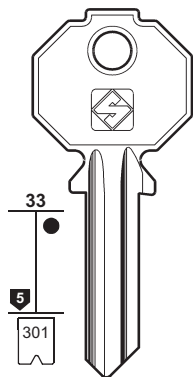

▲ PF072
..... 1-2-3-4-5

PF073

PF15 ▲ PF19

PF9 PF9R

PF12
... 501-700



NONFANGO



143

PER / FOR

PREFER (I)
FOSAM
IMBAC
LIPS VAGO
METALCASTELLI
NONFANGO
O.M.R.
PAS
SERITAL
SWEDA
+ OLIVA (134)
+ TRAU (172)

PRESTA (D)
 BOMORO (33)
 LA PORTE (110)

PER:
FOR:

PREFER

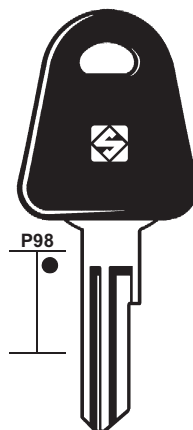
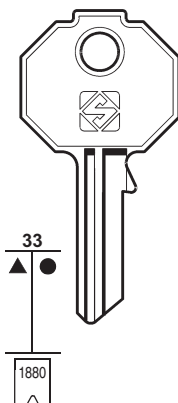
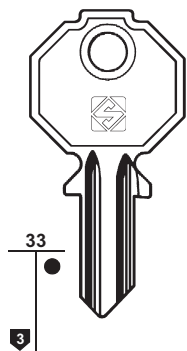
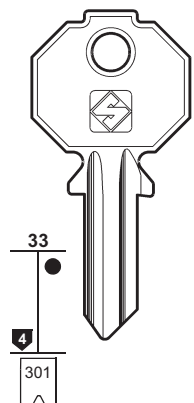

▲ PF070 PF071
..... 501-700

PF4 PF4R

PF1R PF1
..... 1234

PF1RP ▲ PF1P



LIPS VAGO - PAS - SWEDA

FOSAM

METALCASTELLI
SERITAL - O.M.R.

METALCASTELLI

PER:
FOR:

PREFER

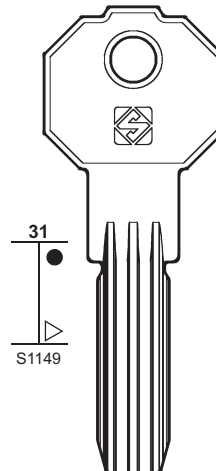
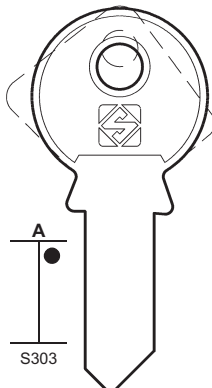
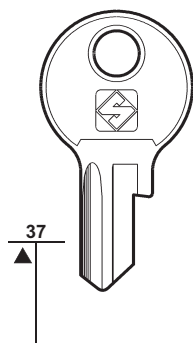
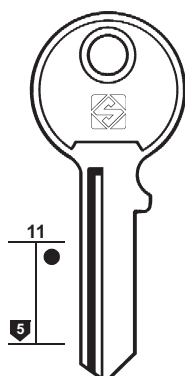

PF13R

PF14

PF18

PF20



IMBAC





144

PER / FOR

PRIM (CH)

PRIVE (RA)
YALE (193)

PROBAT (F)
FTH (81)

PROFILMAR (F)

PROMECA (F)
RONIS (146)

PROMETA (I)

PROMO (I)
PREFER (142)

PROTEC (F)
CITY (51)
KVR (108)

PUNDRRA (USA)

QCP (F)
CITY (51)
ZENITH (201)

RABBIT (HK)

RAFI (D)
DOM (61)

RAM (RC)
YETI (198-199)

RAMIS (ET)

RAUCO (D)
HEKNA (92)

R.C. (I)
CRISTANI (56)

READING (USA)
SEGAL (153)

RECA (I)
INDESIT (96)

REDY (IND)
LOB (114)

REGAL (GB)

REGENT (USA)
HEKNA (92)
HENDERSON (93)

REGISTRATORI DI CASSA (I)

RELIANCE (J)

REMO (I)
ICSA (94)

PER: FOR:	PRIM	PROFILMAR	PROMETA	PUNDRRA

PER: FOR:	RABBIT	RAMIS	REGAL
	0-1-2-3-4-5-6-7-8-9	FP... 626-750	

PER: FOR:	REGISTRATORI DI CASSA	RELIANCE

PER:
FOR:

RENZ

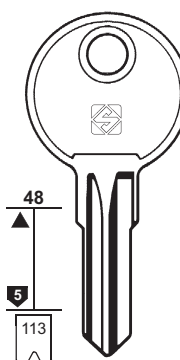
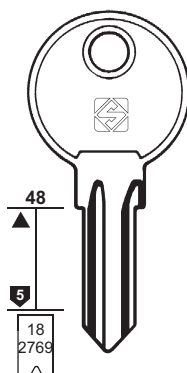
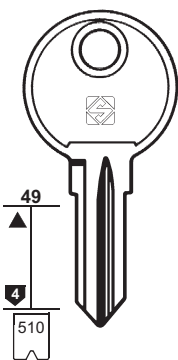
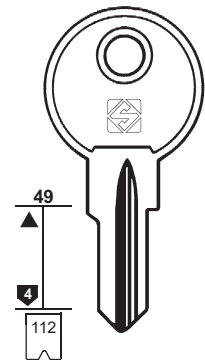

145

KI5
C ... 1-275
XS ... 1-275

KI5R
SX ... 1-275
XT ... 1-75
RX ... 1-275

KI12 ... 151-218 ... 1-68
... 101-150 ... 51-100
... 1116-7776 H ... 500-574
H ... 1116-7776 E ... 1116-7776
E ... 425-499

LS1 R ... 1-224
LS1R V ... 1-224

LS2 AX ... 1-224

KI7
XY ... 1-275

ATAL



PER / FOR

RENZ (D)
ATAL
+ KIFERM (106)
+ LAS (110)

RESMINI (I)

REX (DK)

PER:
FOR:

RENZ

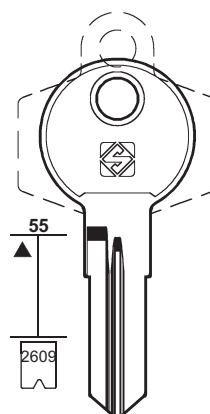
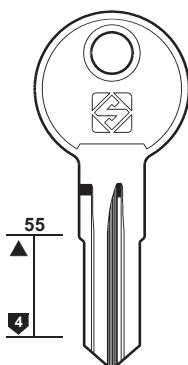
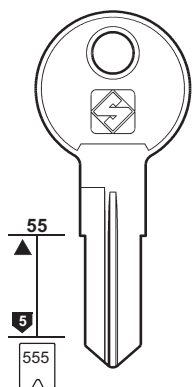
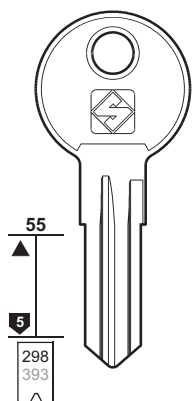

REN4R

REN1 **REN1R**
... 1-200

REN2 **REN2R**
32 ... 001-200

REN3R

REN5R
ER ... 1-500



PER:
FOR:

RESMINI

REX

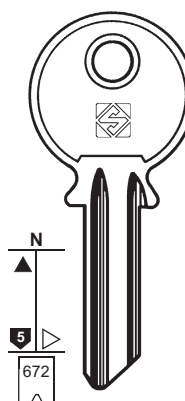
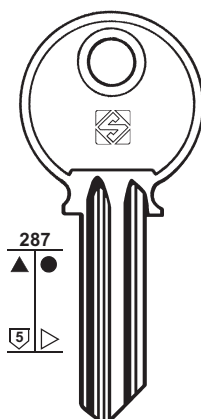
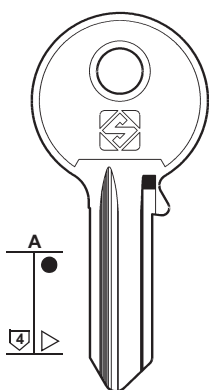
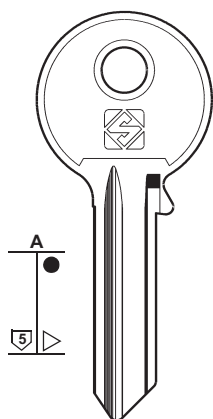

RM1A **RM1RA**

RM2A **RM2RA**

RX2

RX1
K ... 1-50



146

PER / FOR

RGM (E)

RICOUARD (F)

COUILLET
DECAYEUX
KIFERM
LAS
PASSY
YVEL

RIGA (LV)

RIPA (E)

IFAM (95)

RIQUIER (F)

G.R. (89)

RIV (E)

UCEM (175)

RIVERS (AUS)

RJAZAN (RUS)

ROC (F)

YALE (193)

ROLEX (GR)

ZANETTI A. (200)

ROLL-A-DOOR (GB)

+ LEN-LOK (111)

+ L & F (117)

ROMA (I)

RONEO (E)

RONIS (147)

RONIS (F)

ANTAR

BLOCUS

CATOR

DAD

DC

DEBEAURAIN

DELTA

DERLOCHE

DESPREZ

EMGE

EMHART

EQUIBATIR

FONTAINE

FORINDEX

GOLLOT

GUIDOTTI

JIP

LAPERCHE

LIONA-LIOX

MAFOR

MONDIAL

MOREAUX

NUMIDIA

PM

PROMECA

SESA

SOFRANQ

STREMLER

VEGA

+ EMKA (69)

+ LAS (110-111)

+ VACHETTE (181)

PER:
FOR:

RGM

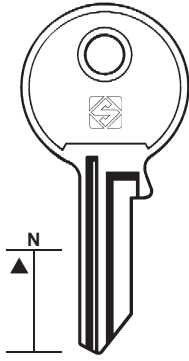

RGM1 RGM1R

RICOUARD

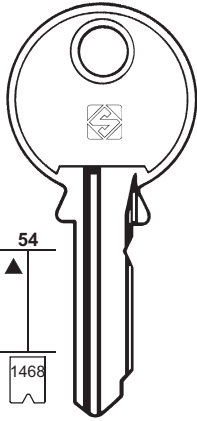

RIC1

K... 726-950

COUILLET - DECAYEUX
KIFERM - LAS - PASSY - YVEL

RIGA

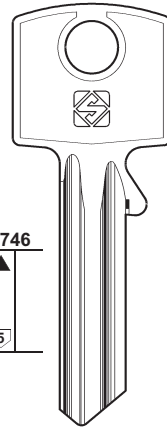

RGA1

RIVERS

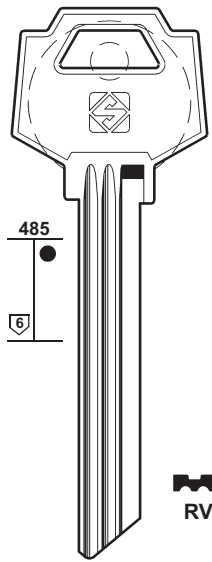

RV1

PER:
FOR:

RJAZAN

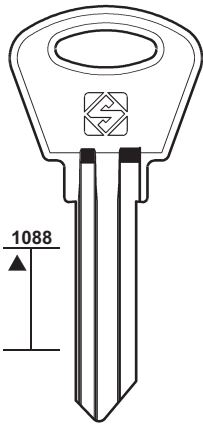

RZA1

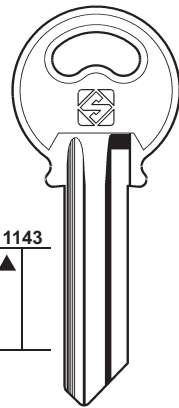

RZA2

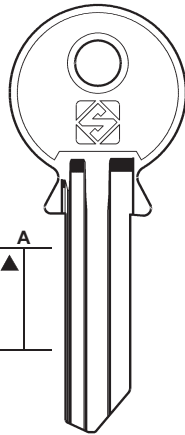

RZA3

ROLL-A-DOOR

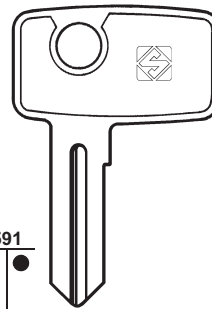

RD1

RD2
19... 1-420

ROMA

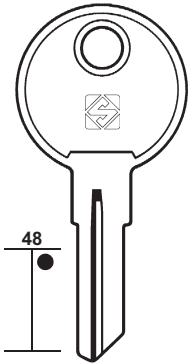

RA1

PER:
FOR:

RONIS

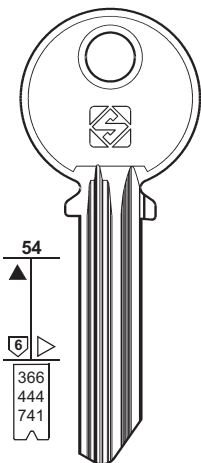

54
366
444
741

0-1-2-3-4-5-6-7-8-9

1-2-3-4-5-6-7-8-9

K...
KK...
N...
NN...
123456789

RO9 RO9R

ANTAR
LAPERCHE - SESA

UUL RO23 RO23R

UUK RO25 RO25R
LAPERCHE

UUM RO27 RO27R
LAPERCHE

RO47 RO47R

RO41 DAD
1-1296
V20... 1-1296
1234567890
A/Z... 1234567890

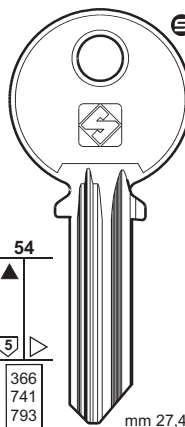

54
366
741
793

mm 27,4

MX... 1100-1699
A/Z... 12345678
A/Z... 12345678
ANTAR... 123456789
BLOCUS... 9... 123456789
CATOR... J... 123456789

RO8

ANTAR
BLOCUS
CATOR

DC

DEBEAURAIN

DELTA

DERLOCHE

DESPREZ

EMGE

EMHART

EQUIBATIR

FONTAINE

FORINDEX

GOLLOT

GUIDOTTI

JIP

LAPERCHE

LIONA-LIOX

MAFOR

MONDIAL

MOREAUX

NUMIDIA

PM

PROMECA

SESA

SOFRANQ

STREMLER

VEGA

RO8R

9 123456789
N 123456789
9... 123456789

TTL RO22 RO22R
FL LAPERCHE

TTK RO24 RO24R
FK FONTAINE
LAPERCHE

TTM RO26 RO26R
FM LIONA-LIOX
LAPERCHE

RO37 RO37R

ET

RO43R

0-1-2-3-4-5-6-7-8-9

PER:
FOR:

RONIS

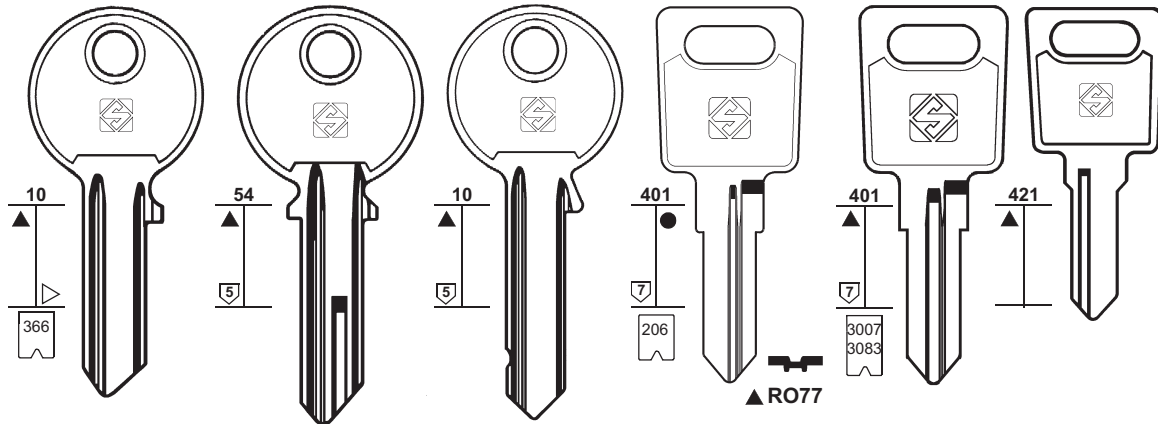

RO7 RO7R
... 0-1-2-3-4-5-6-7-8

RO13

RO14

RO67
NA ...
4001-5000

RO67R
ND ...
4001-5000

RO69
CC ... 1-2000

RO46R

ANTAR - GIMM
JIP - LAPERCHÉ
PM - SESA

SOLOR

CATOR

RO68
NC ...
4001-5000

RO68R
NB ...
4001-5000



147

PER / FOR

RONIS (F)

- ANTAR
- ARMOR
- BURG
- CATOR
- DAV
- EMHART
- EMKA
- FORINDEX
- GIMM
- JIP
- KARDEX
- LAPERCHÉ
- MLM
- NEMEF
- P.J.
- PM
- RONEO
- SANEL
- SCHÄFER
- SESA
- SOLOR
- STRAFOR
- TAV
- YAC
- + EMKA (69)
- + LAS (110-111)
- + VACHETTE (181)

PER:
FOR:

RONIS

RO4
D ... 1-1000
S ... 1-106
T ... 1-106
... 11 1-200
A ... A 1-200
F ... 1-200
1F ... 1-21
TA ... 1-224
PS ... 1-30
GV ... 1-300
... F 1-500
... C 101-600
C ... 101-600
C ... 11111-44444
... A ... 12345
00 ... 12345
C ... 12345
T ... 313-380
... 11 501-700
A ... A 501-700

RO4R
E ... 1-1000
... 15 1-200
... Y 101-600
Y ... 101-600
S ... 107-212
T ... 107-246
Y ... 11111-44444
Y ... 12345
1F ... 22-29
T ... 381-400
... 15 501-700

RO20
... E 12345
2 ... 12345
F ... 12345
S ... 247-279
T ... 247-279
1F ... 30-33
... 400-520
2 ... 400-520
... E 601-800
E ... 601-800

RO20R
... A 12345
S ... 280-312
T ... 280-312
... A 400-520
... A 601-800
A ... 601-800

EMKA

RO15 RO15R
A8 ... AA-DS
... 8 AB-ZZ
S ... 385-402

RO15R
A9 ... AA-DS
... 9 AB-ZZ
S ... 403-420

RO45 RO48R

RO30 RO30R
F ... 1-500
Z ... 1-900

RO38 RO38R
H ... 1-1000

RO42 RO42R
... ZA1-ZZ3

RO50
B ... 1-20

EMHART - MLM
NEMEF - SCHÄFER

ARMOR - DAV - FORINDEX - KARDEX
RONEO - SANEL - STRAFOR - YAC

PER:
FOR:

RONIS

RO44 RO44R

RO34 RO34R
N ... 601-983 P ... 601-983

RO49
CH ... 101-751
GZ ... 101-751

RO51 RO51R

RO53R

BURG - STRAFOR - TAV



148

PER / FOR

ROSSETTI (R)

ROSTEX (CZ)

LOB (114)

ROYAL (RC)

ABUS (8)

COLE (52)

GUARD (90)

VIRO (187)

YETI (198-199)

R.S.M. (GB)

P.C.

CORTELEZZI (140)

RUFFLER &

DEITH (GB)

SIDLEEN (154)

RUFFLER &

WALKER (GB)

SIDLEEN (154)

RUKA (D)

DOM (61)

VACHETTE (182)

RUKO (DK)

ASSA

DIFA

RUSSIA (RUS)

RUSSWIN (USA)

ROSSETTI

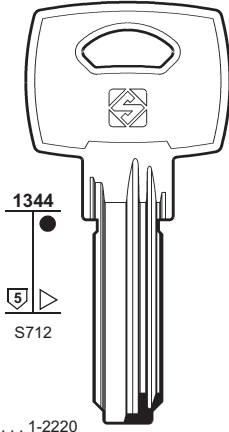

... 1-2220



RUKO

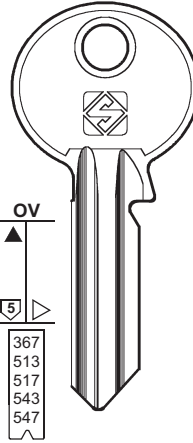

367
513
517
543
547



RU1
..... 1-2-3-4-5-6-7-8
..... 1-2-3-4-5-6-7-8-9
..... 1-2-3-4-5-6-7-8-9-0-A-B
..... 0-1-2-3-4-5-6-7-8-9-A-B-C-D-E-F-G-H-L-M
S..... 1-2-3-4-5-6-7-8-9



DIFA

RUKO

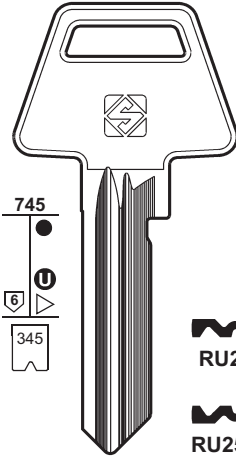

6



RU14
..... ABCDEFGHJ



ASSA

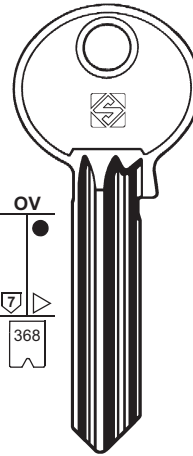

7



RU6
1-2-3-4-5-6-7-8-9-A-B-C

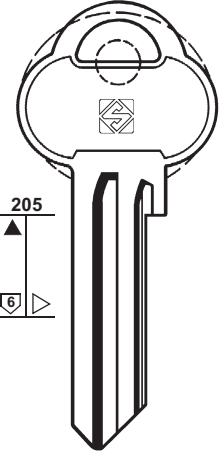

6



RUSSIA

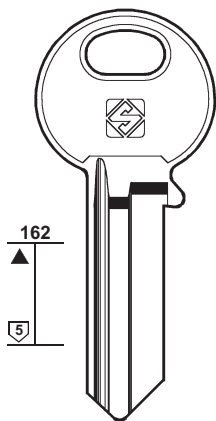

5

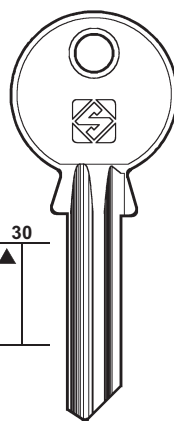

30

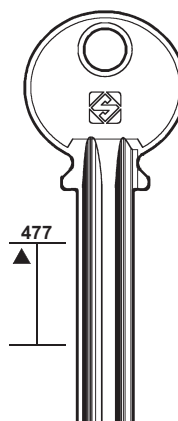

477

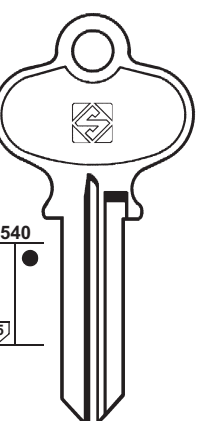

540

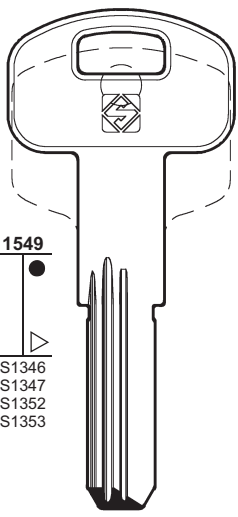
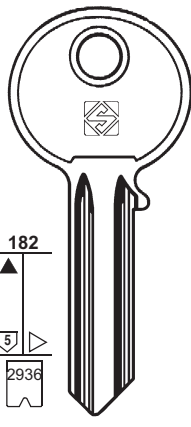
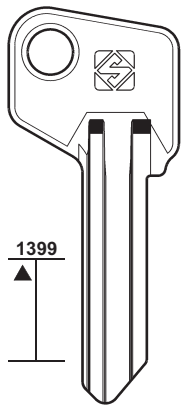

PER: FOR:	S-TECH	SABI	SAM
	 <p>1549</p> <p>S1346 S1347 S1352 S1353</p> <p>SCH1R</p>	 <p>182</p> <p>5</p> <p>2936</p> <p>..... 01234567</p> <p>SB1</p>	 <p>1399</p> <p>SMA1</p>

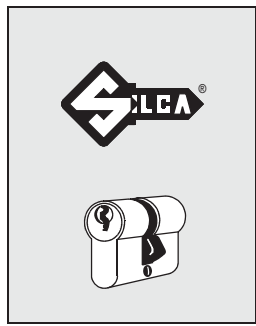

149

- PER / FOR
- S-TECH** (GB)
 - SAB** (I)
 - 👁️ TAMPALINI (164)
 - SABI** (ET)
 - SAFE** (I)
 - SAM** (RUS)
 - SAMA** (F)
 - 👁️ FTH (82)
 - SAMSONITE** (USA)
 - SANCHUN** (RC)
 - 👁️ YETI (198-199)
 - SANEL** (F)
 - 👁️ RONIS (147)
 - SANPEUR** (F)
 - 👁️ VACHETTE (180)
 - SÄNTIS** (CH)
 - + 👁️ CES (41-42)
 - SANTOS** (P)
 - 👁️ OMEC (135)
 - 👁️ P.C. (CORTELLEZZI) (139)
 - SANWA** (J)
 - SANY** (F)
 - 👁️ ALPHA (15)

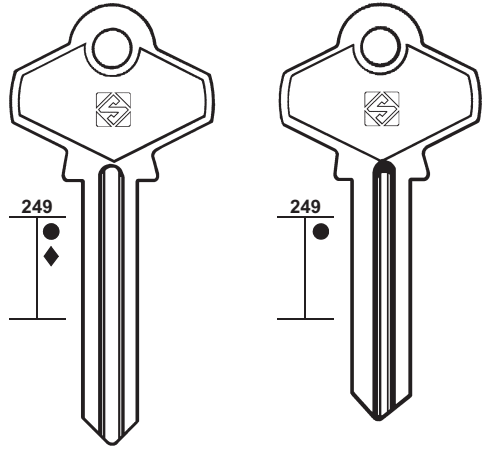
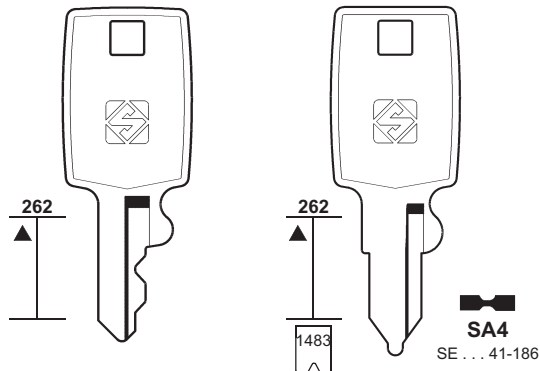
PER: FOR:	SAFE	SAMSONITE
	 <p>249</p> <p>SF1</p> <p>SF2</p>	 <p>262</p> <p>1483</p> <p>SA4 SE... 41-186</p> <p>SA1 170 S SA1R</p> <p>SA2 70 S SA2R</p> <p>SA3 SE... 315-396 SA3R SE... 231-294</p> <p>SA5 SA5R</p>

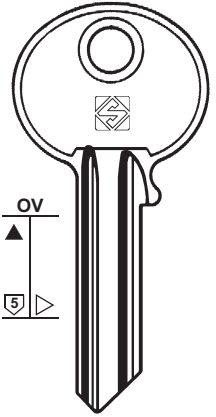
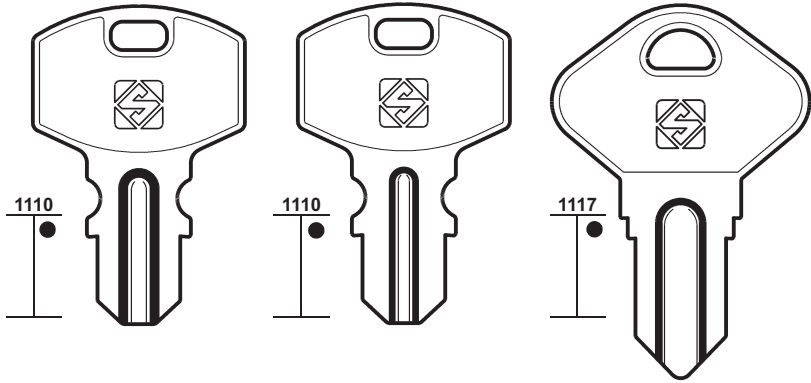
PER: FOR:	SÄNTIS	SANWA
	 <p>OV</p> <p>5</p> <p>SAN1 SAN1R</p>	 <p>1110</p> <p>1110</p> <p>1117</p> <p>SNW1 SNW2 SNW3</p>



150

PER / FOR

SARATOV (RUS)

SARGENT (USA)
BRICARD
KESO
SHOWA

SARGENT & GREENLEAF (USA)
SLAYMAKER (157)

PER:
FOR:

SARATOV

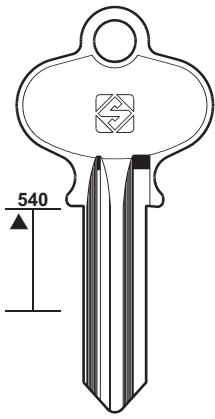

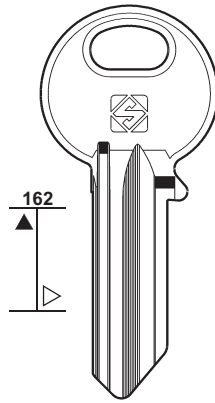

SRT1

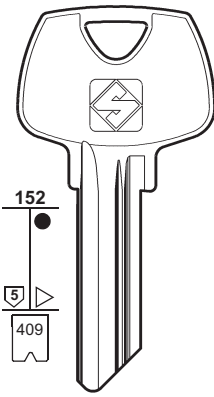

SRT2

SARGENT





SAR8

▲ SAR17

.....
1-2-3-4-5-6-7-8-9-0

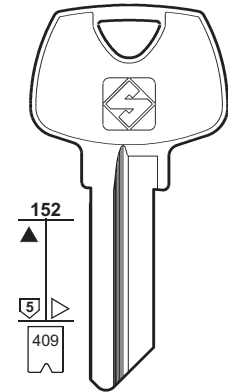

PER:
FOR:

SARGENT



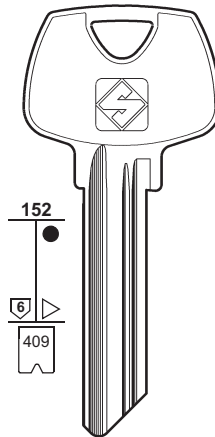

SAR17R
.....
1-2-3-4-5-6-7-8-9-0



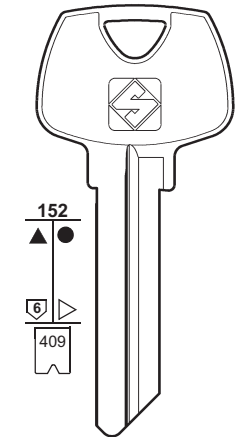

SAR21 
SAR3
.....
1-2-3-4-5-6-7-8-9-0





▲ SAR22R
.....
1-2-3-4-5-6-7-8-9-0

SAR3R
.....
1-2-3-4-5-6-7-8-9-0

▲ SAR21R

PER:
FOR:

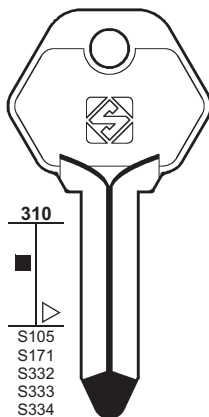
SARGENT



S105
S171
S332
S333
S334
S335
S336
S598
S599
S600
S601

KE4

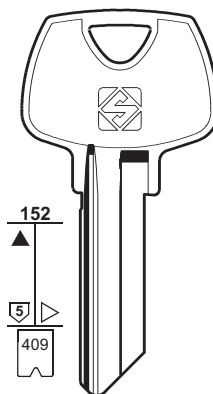

SAR1
S
.....
1-2-3-4-5-6-7-8-9-0

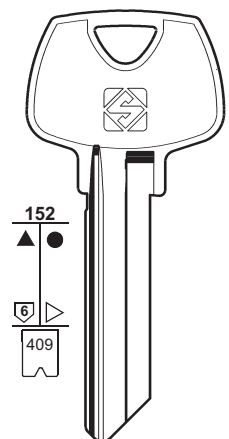

SAR2 
▲ SAR4R
S
.....
1-2-3-4-5-6-7-8-9-0

BRICARD - SHOWA

BRICARD - SHOWA

SATURN			SAVE	
OV ▲ 587	37 ▲ 5	1346 ● S1103	1047 ▲ ▶	1329 ▲ ▶
STU1	STU3	STU6R	SVE1R	SVE2R
1-2-3-4-5-6-7-8-9	mm 50	BASI		
GERA - VERA				



151

PER / FOR
SATURN (SLO) BASI GERA VERA
SAVE (CZ)
SAVIO (I) AGB (11) JVAL (102) P.C. (CORTELLEZZI) (139)
SCHÄFER (D) RONIS (147)
SCHÄRF (D) HUWIL (94)
SCHLAGE (I) (USA) BALDWIN EPO TACO

SCHLAGE				
249 ● ◆	583 ●	301 ▲ ▶ 401		301 ● ▶ 410
SH1 A	SH2 W	SH5R	SH27	T SH12R
EPO		A/Z 0123456789 A/Z-A/Z 0123456789		A/Z 0123456789 A/Z-A/Z 0123456789

SCHLAGE	
	<p>..... 0123456789 C </p> <p>..... A 0123456789 SH3</p> <p>S 100-27787 BALDWIN</p> <p>CE </p> <p>● SH17</p> <p>E </p> <p>● SH11</p> <p>EF </p> <p>▲ SH8</p> <p>F </p> <p>▲ SH9</p> <p>FG </p> <p>● SH18</p> <p>G </p> <p>▲ SH12</p>
301 ▲ ●	<p>H </p> <p>● SH13</p> <p>J </p> <p>▲ SH14</p> <p>K </p> <p>▲ SH15</p> <p>L </p> <p>SH16</p> <p>A/Z 0123456789</p> <p>A/Z-A/Z 0123456789</p>
410 ▶ 546	
TACO	



152

PER / FOR**SCHLAGE** (I) (USA)
BALDWIN
TACO**SCHLECHTENDAHL** (D)
CASI
HUTRA
NORDWEST**SCHLEGEL** (D)
DOM (61)**SCHÜCO** (D)
CISA (48)
KFV (105)**SCHULTZ** (D)
EURO LOCKS (71)**S & E** (F)
PICARDIE (141)**SE** (F)
G.R. (89)**SEA** (CH)
EZCURRA
HASLER
VIDMAR**SEAT** (I)
MICHEL
SICCAF**SECURE** (GB)
STA-LOCKPER:
FOR:

SCHLAGE

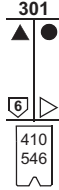
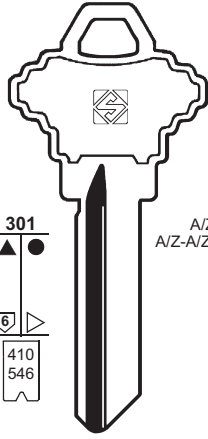
..... DG C
0123456789**SH5**
BALDWINCE
SH23A/Z 0123456789
A/Z-A/Z 0123456789E
SH10EF
SH6F
SH7FG
SH24G
SH19H
SH20J
SH21K
SH22L
SH4A/Z 0123456789
A/Z-A/Z 0123456789

TACO

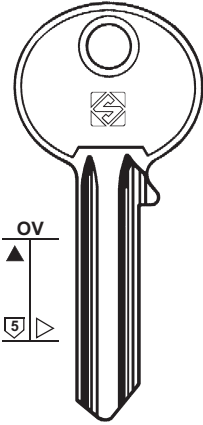
PER: **SCHLECHTENDAHL**
FOR:**SEA****ST1**

CASI - HUTRA - NORDWEST

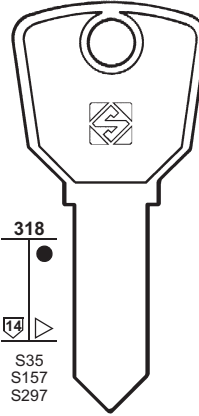
**SEB1**
20-23

EZCURRA - HASLER

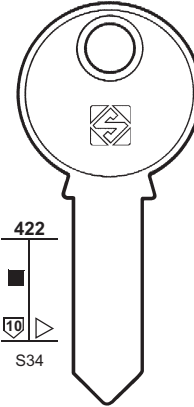
**SEB2**

EZCURRA - HASLER - VIDMAR

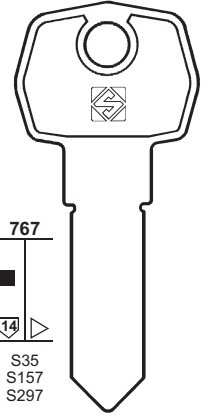
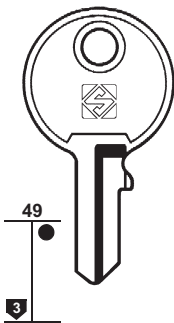
**SEB3**
20-23PER: **SEAT**
FOR:**SECURE****SEA4****SEA4R**

MICHEL - SICCAF

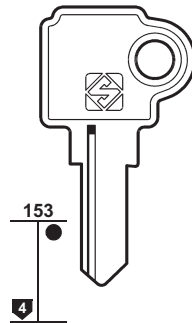
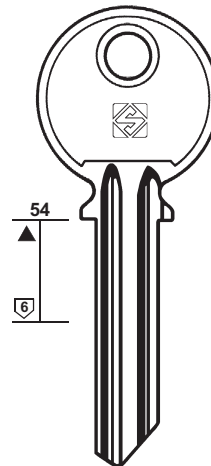
**SEA5** **SEA5R****SEA7** **SEA8****SC1**

STA-LOCK

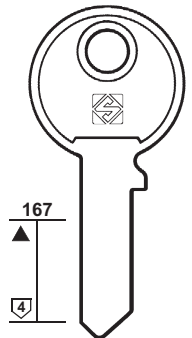
**SC2**

STA-LOCK

PER:
FOR:

SECUREMME

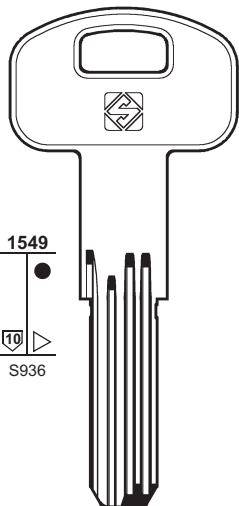

1549
S936

SCM1R
K2

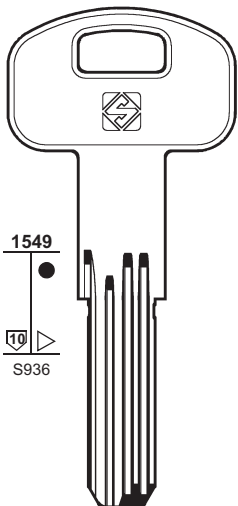

1549
S936

SCM2
K1

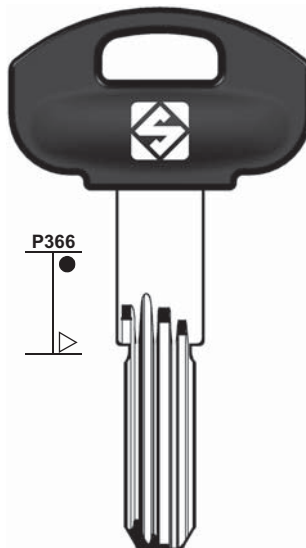

P366

SCM3RP



153

PER / FOR

SECUREMME (I)

SECURITAL (I)

KYR
+ ABUS (9)
+ FORT (81)

SEEBURG (USA)

ILLINOIS (96)

SEGAL (USA)

HUDSON
READING

SEIM (F)

KIFERM (106)

SELECT (F)

SELMACH (RUS)

SEMEL (F)

JIS (99)

SEN (D)

KFV (105)

SERITAL (I)

PREFER (142)

SERRALLER (E)

AGA (11)

SES (F)

MELSMETAL (122)

SESA (F)

RONIS (146-147)

SEZAN (RC)

YETI (198-199)

SHANGHAI (PRC)

CINA
+ CINA (48)

PER:
FOR:

SECURITAL

SEGAL

SELECT

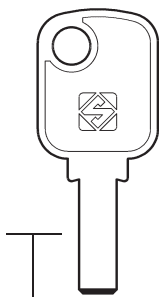

ZAMA
S39
S612
S760
S761
S1265
S1391

SCU1

KYR

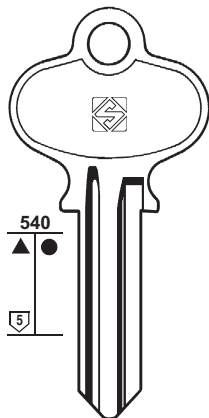

540
5

SL1
A
K9

HUDSON - READING

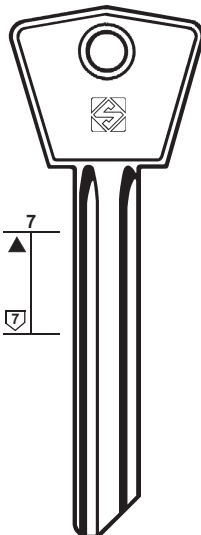

7
7

SE8

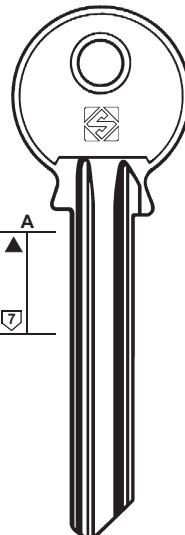

A
7

SE7

SE7R

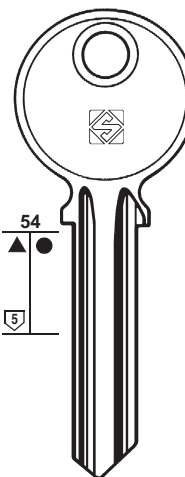

54
5

SE5

SE5R

PER:
FOR:

SELECT

SELMACH

SHANGHAI

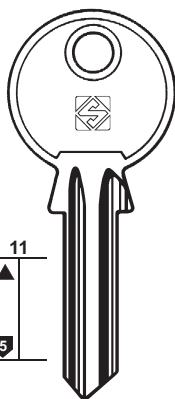

11
5

SE3

SE3R

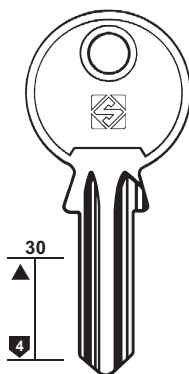

30
4

SE1

SE1R

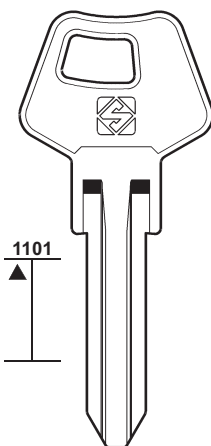

1101

SEM1

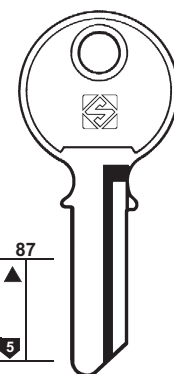

87
5

SG1

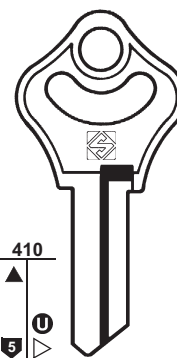

410
5

SG808

SG808R



CINA





154

PER / FOR

SHAW (GB)
+ HTV (93)

SHILUTE (RUS)

SHOWA (J)
+ SARGENT (150)

SIAM (DZ)
+ CITY (51)
+ SIMECA (155)
+ ZENITH (201)

SICCAF (I)
+ SEAT (152)

SICMA (F)
+ ZENITH (201)

SIDLEEN (GB)
BANHAM
EXCEL
REGENT
RUFFLER & DEITH
RUFFLER & WALKER

SIEBAU (D)
+ CES (42)
+ TOK-WINKHAUS (170)

SIGENIA (D)
+ POS (141)

SIGMA (PL)

SIL (P)

PER: FOR:	SHAW	SHILUTE	SHOWA
	 SHW1	 SHW2	 SHT1
			 SWA10

PER: FOR:	SHOWA	SIAM	SIDLEEN
	 SWA1 1-2-3-4-5-6-7-8-9	 SIA1R	 SD1
			EXCEL

PER: FOR:	SIDLEEN	SIGMA	SIL
	 SD2 BANHAM RUFFLER & DEITH RUFFLER & WALKER REGENT	 SD3T	 SGM1
			 SIL1R

PER: FOR:	SILCA	SILVANA
	<p>PC12T</p> <p>SLC1TP</p> <p>SLC3T</p> <p>PC15T</p> <p>SLC2TP</p>	<p>SVN1</p> <p>SVN2</p>



155

PER / FOR
SILCA (I) + P.C. CORTELLEZZI (140)
SILVANA (BR)
SIMATIC (CH) SIMECA (155)
SIMECA (CH) CAB GIUSSANI GUTLER JPM KATE ORBA SIAM SIMATIC
SINA (I) ZANI (200)
SINJET (D) DOM (61)
SIS (I) ZENITH

PER: FOR:	SIMECA
	<p>SM2</p> <p>SM3</p> <p>SM4</p> <p>SM5</p> <p>SM10R</p> <p>SM14R</p> <p>SM9R</p> <p>SM9 40</p> <p>SM6 Z1</p> <p>SM8 Z3</p> <p>SM16</p> <p>SM1R</p>
	<p>GUTLER - KATE ORBA - SIAM - SIMATIC</p> <p>JPM</p> <p>CAB GIUSSANI</p>

PER: FOR:	SIMECA	SIS (I)
	<p>SM15</p> <p>SM13</p> <p>SM12</p> <p>SM11</p>	<p>SS1</p> <p>SS1R</p> <p>SS3</p> <p>SS3R</p> <p>SS10 UTZ</p> <p>ZENITH</p>



156

PER / FOR

SIS (I)
 FEL
 LÄSBOLAGET
 PICARDIE

SIS (P)

SISO (I)
 + CAS-CISMA (40)
 + EVERGOOD (71)
 + OJMAR (134)

SJL (RUS)

SKILLMAN (USA)
 CORBIN (54)

PER:
FOR:

SIS (I)

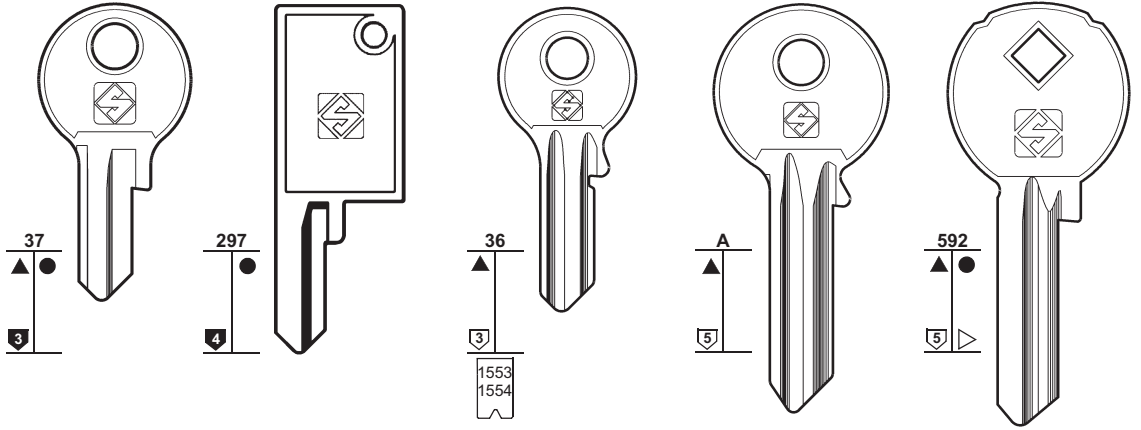

SS9

SS6

SS14 SS14R
... 7654321

SS12

SS7 ●SS7R



PICARDIE

LÄSBOLAGET

PER:
FOR:

SIS (I)

SIS (P)

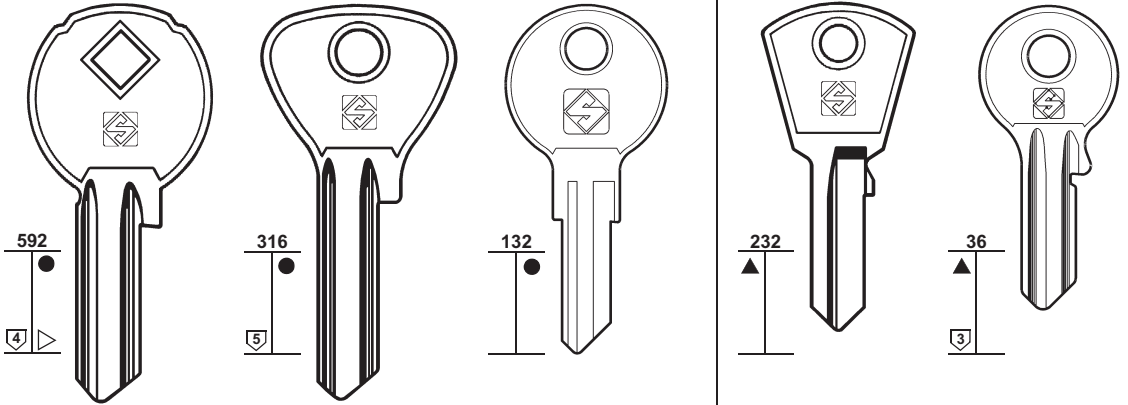

SS8

SS4

SS13

SSP1

SSP5

SSP1R

PER:
FOR:

SIS (P)

SISO

SJL

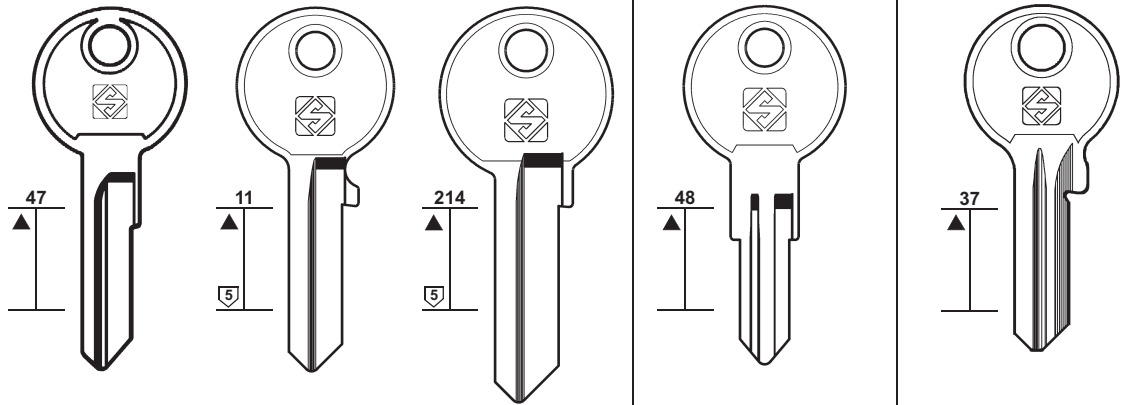

SSP2





SSP4 SSP4R

SSP6

SSO1 SSO2

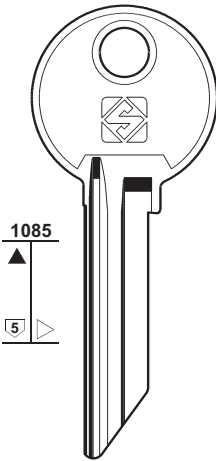
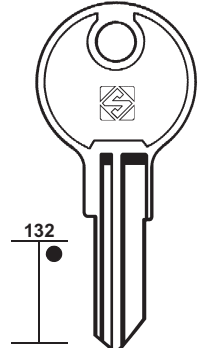
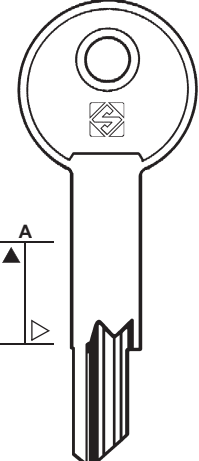
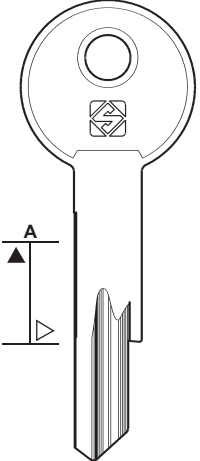
SJ1R











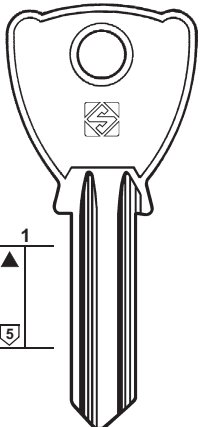
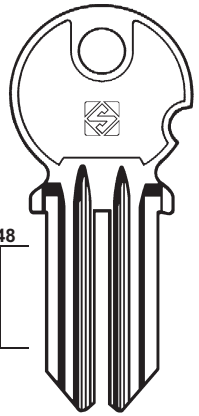
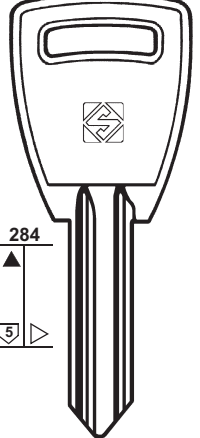





PER: FOR:	SKMZ	SLAYMAKER	SOBINCO	
				
	1085 ▲ 5	132 ▲	A ▲	A ▲
	 CKM1	 SY1	 SN3R	 SN4R
		SARGENT & GREENLEAF		

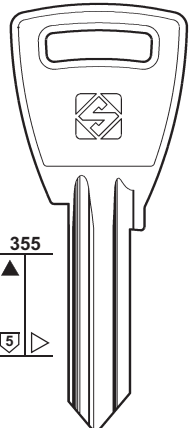
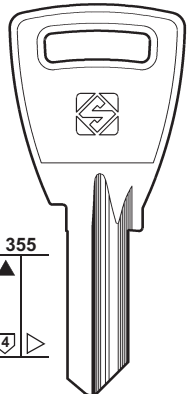
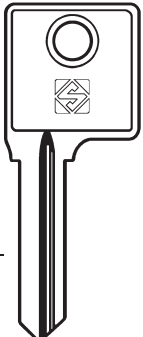
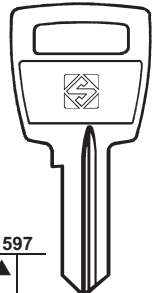

157

PER / FOR
SKMZ (UA)
SLAYMAKER (USA) SARGENT & GREENLEAF
SOBINCO (B) + SOFI-SONAFI (157)
SOF (F) GLOBE (87-88)
SOFER (P)
SOFI-SONAFI (P) CHAVO SOBINCO
SOFRANQ (F) RONIS (146)

PER: FOR:	SOBINCO	SOFER	SOFI-SONAFI
			
	1 ▲ 5	448 ▲	284 ▲ 5
	 SN1	 SOF1	 S1
	 SN1R	 SOF1R	 S1R
	 SN2		
	 SN2R		
	012345678		CHAVO

PER: FOR:	SOFI-SONAFI				
					
	355 ▲ 5	355 ▲ 4	325 ▲ 5	597 ▲ 4	317 ▲ 4
	 SI4	 SI6R	 SI3R	 SI5R	 SI2R
					SOBINCO



158

PER / FOR

SOLER (E)

SOLID (RSA)

CES (42)

SOLOR (F)

RONIS (147)

SONICO (BG)

SOPRANO (BR)

SOLER

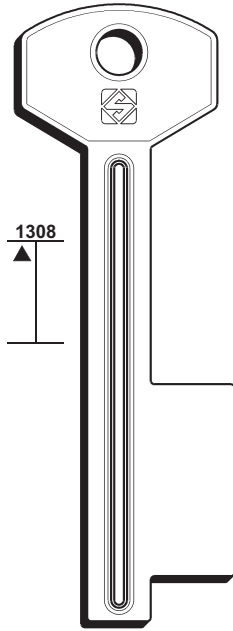

SLR1

SONICO

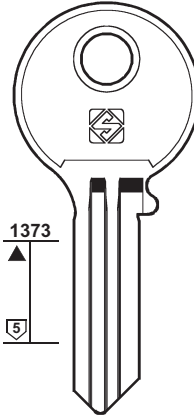

SNC1



SNC2



SNC2R

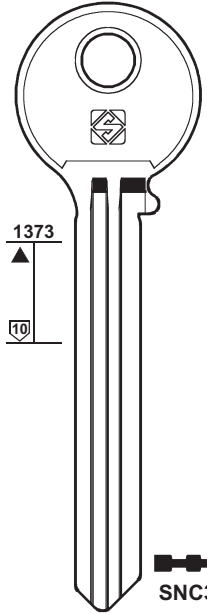

SNC3

SOPRANO

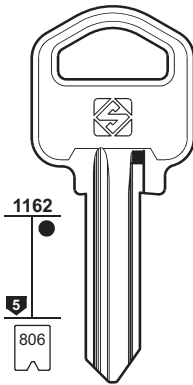

SOP1

1-2-3-4-5-6-7-8-9

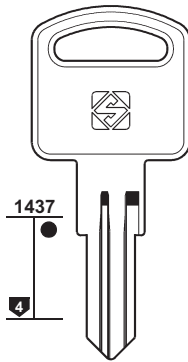

SOP2

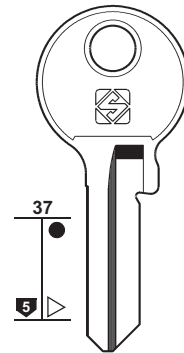

SOP10

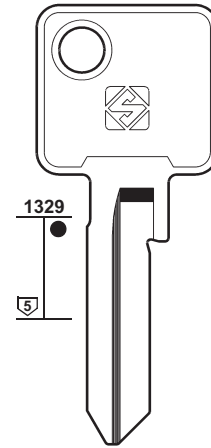

SOP11

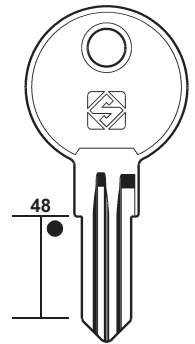

SOP12

SOPRANO

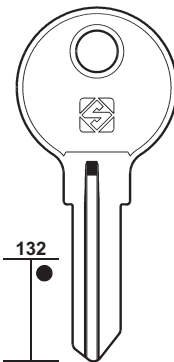

SOP15R

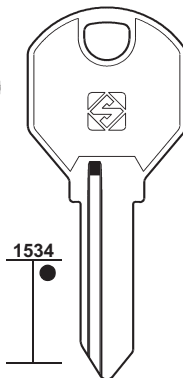

SOP13R

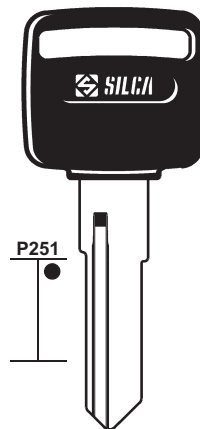

SOP14RP

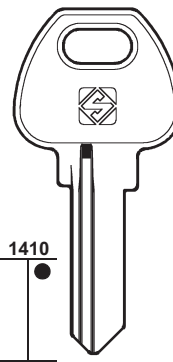

SOP16R

1-2-3-4-5

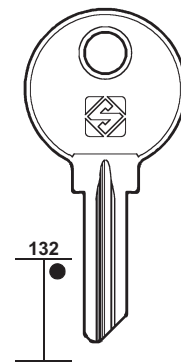

SOP17R

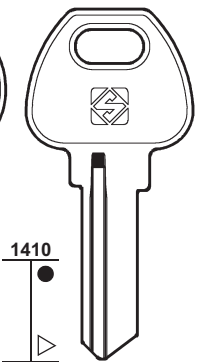

SOP18R

PER:
FOR:

SOS

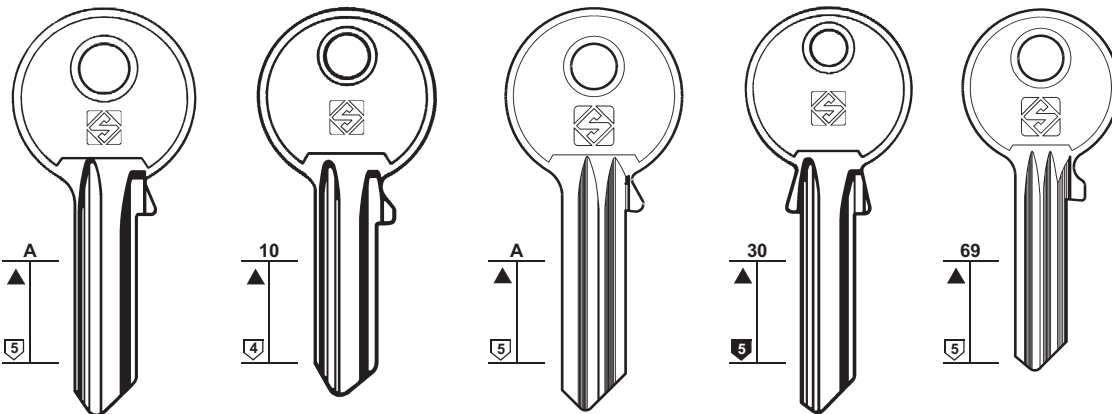

SO4

SO7



SO5



SO8R



SO6



SO9



159

PER / FOR

SOS (F)

- + CITY (51)
- + GABON (84)
- + MING-TAY (126)
- + TESA (165)
- + YALE (195)

SOUTHCO (GB)

- YALE (194)

SP (F)

- FTH (81)
- MUL.T.LOCK (131)

SPEEDAL (I)

- CES (43)

SPIDER (IL)

- CAVERS
- CODKEY

SQUIRE & SONS (GB)

SS (D)

- CES (42)

STA-LOCK (GB)

- SECURE (152)

PER:
FOR:

SOS

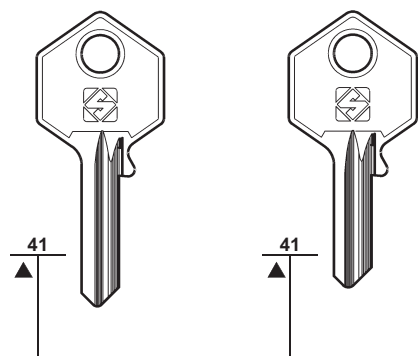

SO10R



SO11R



mm 25

SPIDER

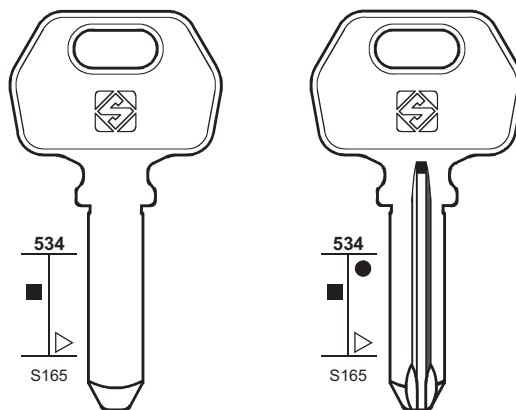

SPR1



SPR2



CODKEY



CAVERS

PER:
FOR:

SQUIRE & SONS

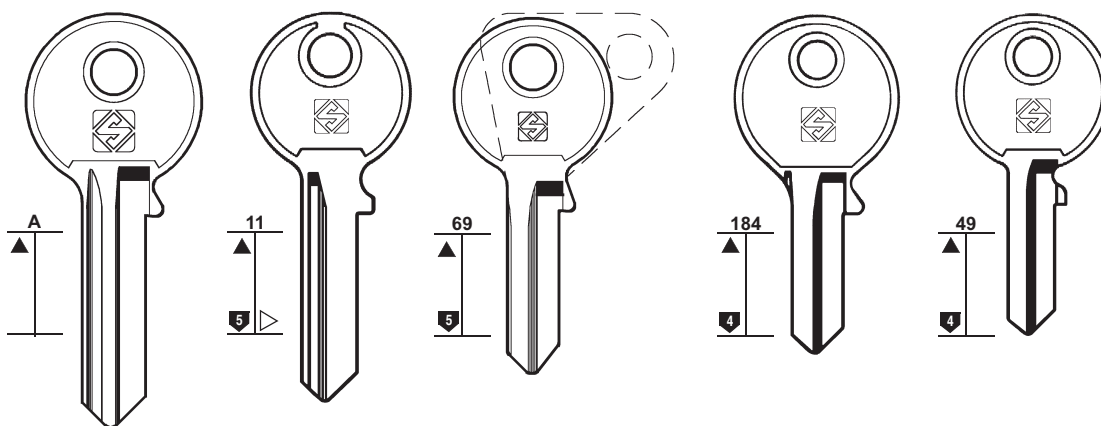

SQ4R



SQ3R



SQ5



SQ1



SQ2





160

PER / FOR

STAM (BR)

STANDARD (D)

CISA (48)

STANOFDRO (PRC)

PER:
FOR:

STAM

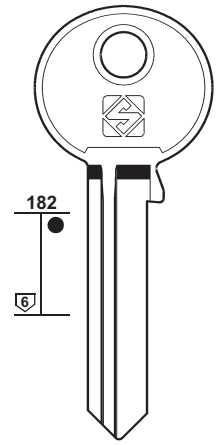
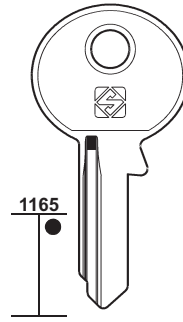
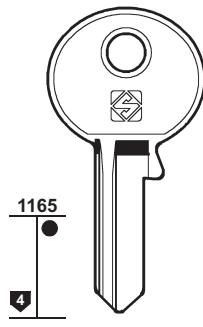
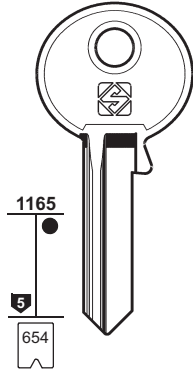

SAM1



SAM1R

..... 1-2-3-4-5-6-7-8



SAM14



SAM9R



SAM15R



SAM13



SAM13R



SAM4

PER:
FOR:

STAM

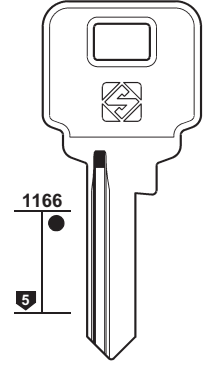
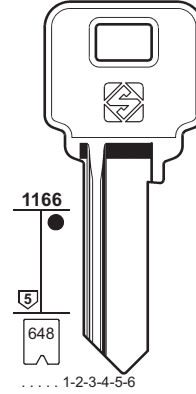
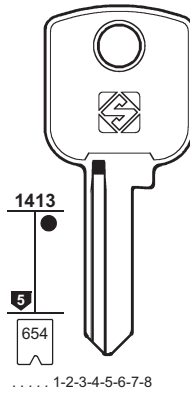
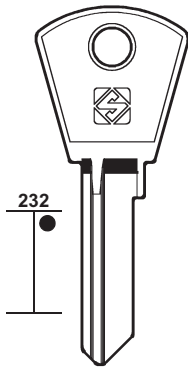

SAM6



SAM16R



SAM12R



SAM2



SAM2R



SAM3R

PER:
FOR:

STAM

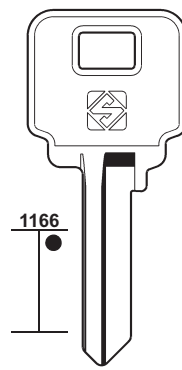
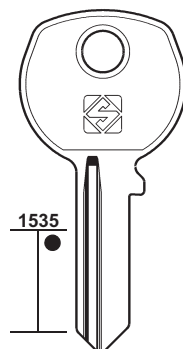
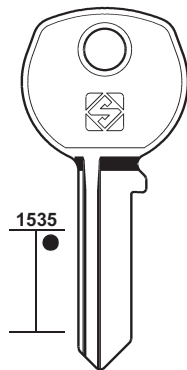

SAM10



SAM11R



SAM8

STANOFDRO

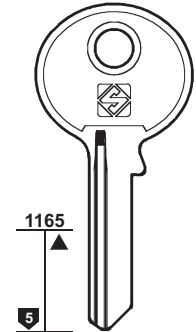

SFD1R

PER:
FOR:

STAR

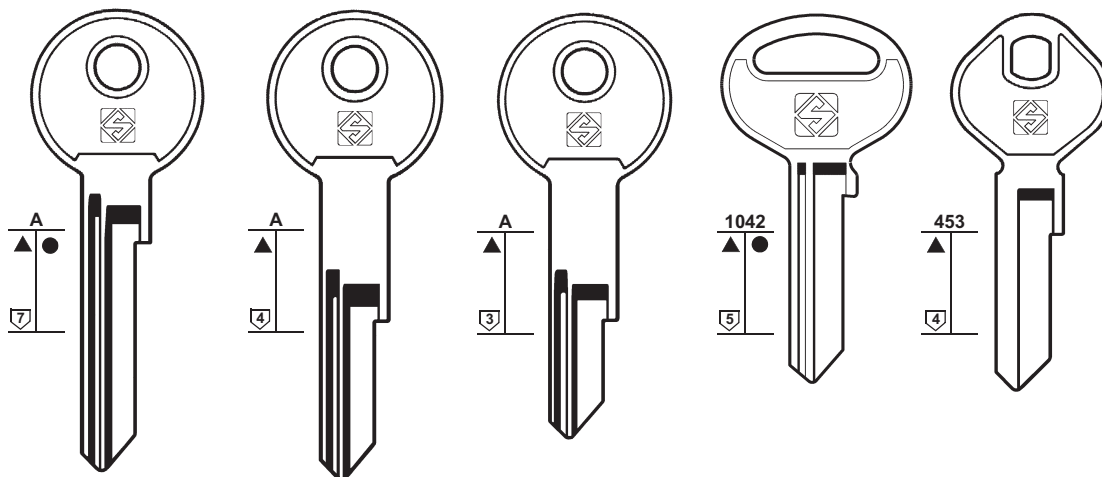

 ●



161

PER / FOR

STAR (J)
GS
IJ
TEC
+ ISEO (97)

STARLET (D)
GERA

STARRY (NL)

STEELCASE (USA)
 CHICAGO (45)
 HUWIL (94)

STEIGA (D)
 DOM (62)

STIQAM (TN)
 CAS-CISMA (40)

PER:
FOR:

STAR

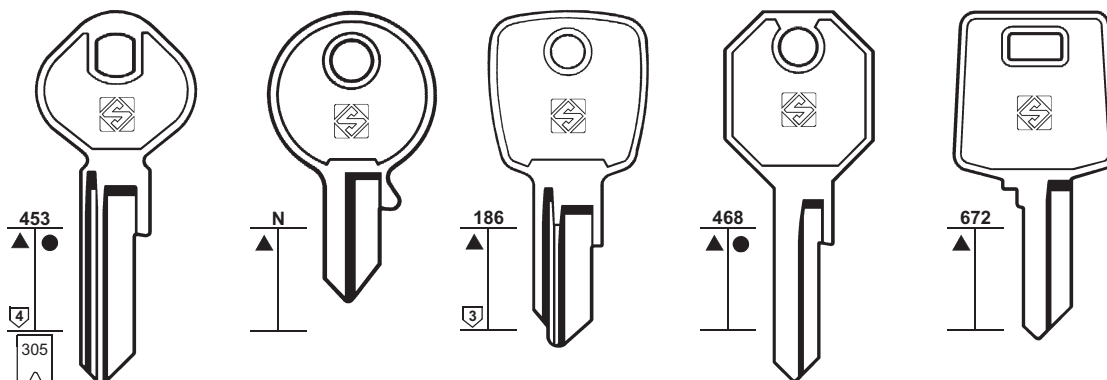

K... 1-1600



PER:
FOR:

STARLET

STARRY

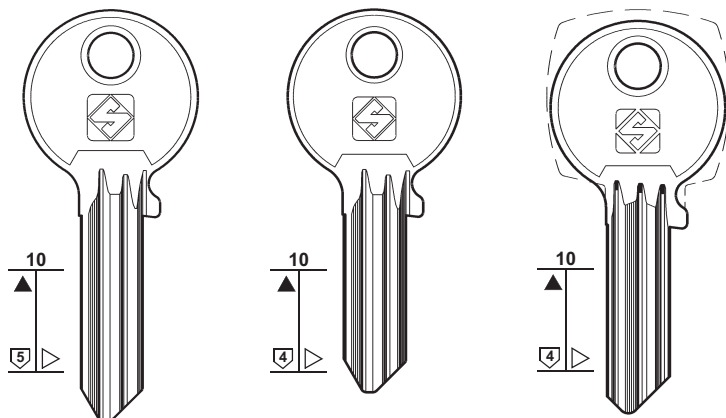

GERA

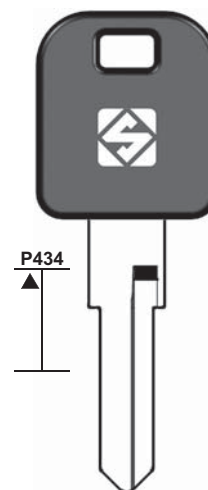



162

PER / FOR

STORWALL (GB)

STRAFOR (GB)

- HUWIL (94)
- LAS (110)
- RONIS (147)

STREBOR (GB)

STREMLER (F)

- BRICARD (35)
- CAS-CISMA (40)
- CORBIN (53)
- RONIS (146)

STS (E)

ALSO
ARFE
BTV

- + ARFE (17)
- + DOM (61-62-63)
- + ELCA (68)
- + PICARDIE (141)
- + TESA (166)

STUBLINA (SCG)

STUMPF (D)

- + OJMAR (134)

PER: **STORWALL**

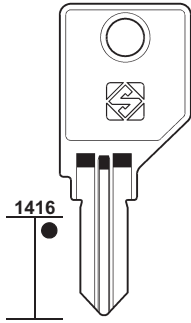

SWL1

PER: **STREBOR**

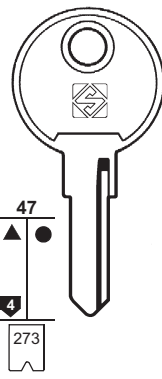

STR5
F... 402-480

STR5R
F... 503-581

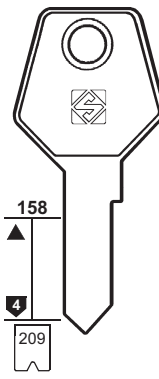

STR3
S... 1-70

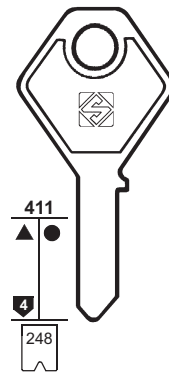

STR4
RR... 502-579

STR4R
RR... 502-579

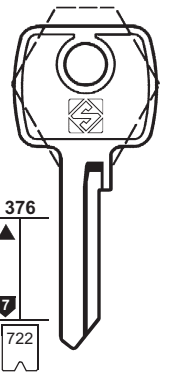

STR6
MT... 1-989

PER:
FOR:

STS

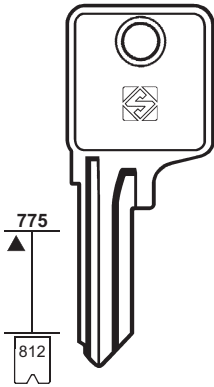

STS1 STS1R
.....
(625) 0-1-2-3-4-5



ALSO

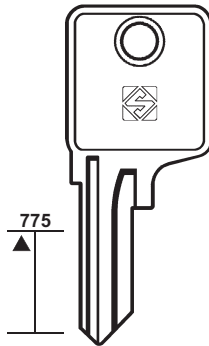

STS2 STS2R

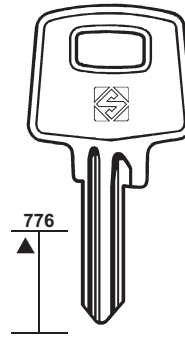

STS3



BTV

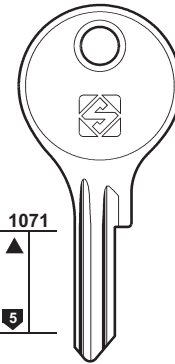

STS4

ARFE

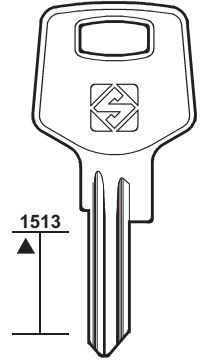

STS11

PER:
FOR:

STS

STUBLINA

STUMPF

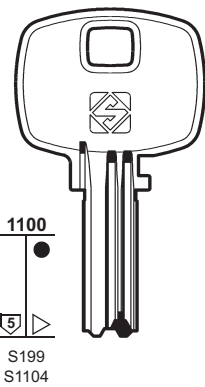

S199
S1104

STS5

K... 5001-8030

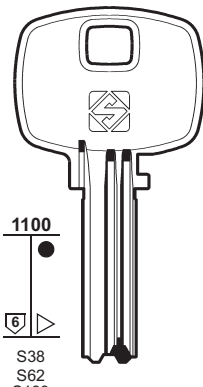

S38
S62
S199
S436
S1104

STS6 ⊕

J
K

P... 5001-8030
K... 5001-8030

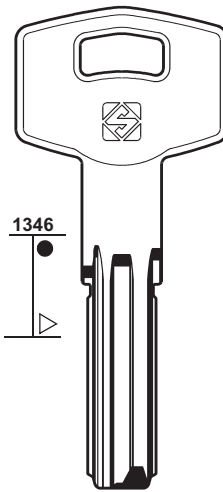

STS9

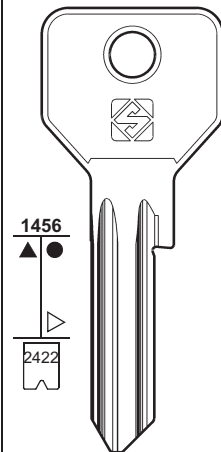

2422

STN1

STN1R

..... 12345678

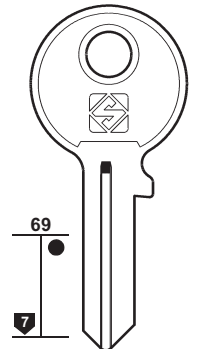

STF1

STF1R

PER:
FOR:

STUV

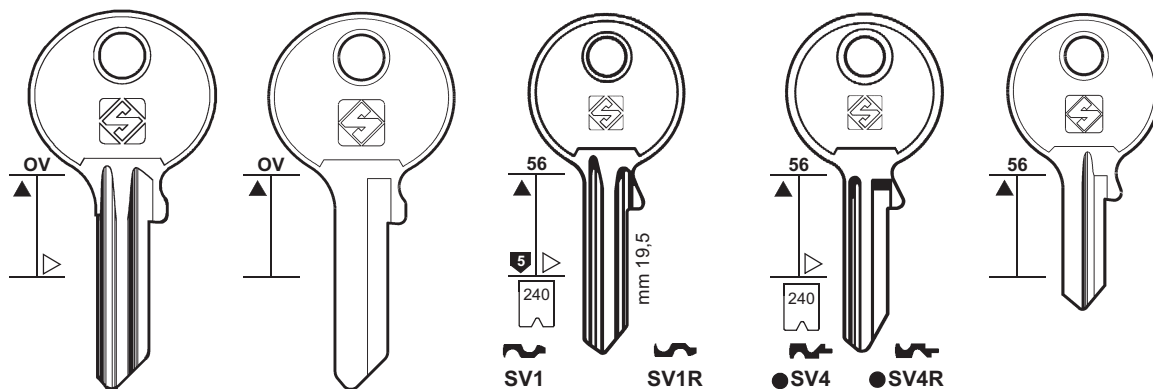

SV1 2F ... 201-278
1F ... Z 201-278
1F ... X 201-278

SV1R 1F ... 201-278
1F ... Z 201-278
1F ... X 201-278

SV4 ●
SV4R ●

SV5R ●

SV3 **SV3R**

SV7

SV2R

SV2

SV8 **SV8R**

2F ... 201-278
1F ... Z 201-278
1F ... X 201-278

SV6R



MLM - DOM



163

PER / FOR

STUV (D)
DOM
MLM
+ CES (41-42)
+ DOM (62)
+ MLM (127)

STV (I)
 OMIV (136)

SUF (F)
 FTH (82)

SUKI (J)
 FLORA (81)

SUL (I)
 CORBIN (53)
 P.C. CORTELLEZZI (140)

SUNSUI (RC)

SUPER (RC)

SUREX (F)
ATLAS
EUROP
MATTEY
+ GABON (84)
+ YALE (194)

SURFINOR (F)
 FICHET (80)

SUYOKA (J)
 AGA (10)

SWAN (I)
 YETI (198-199)

PER: **SUNSUI**
FOR:

SUPER

SUREX

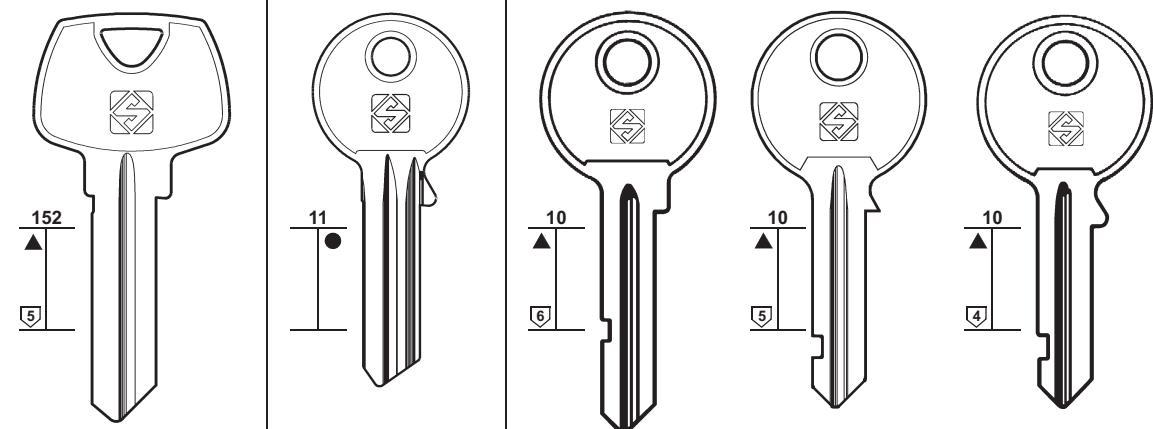

SU1R

SPU1R

SR8

SR7

SR6

PER:
FOR:

SUREX

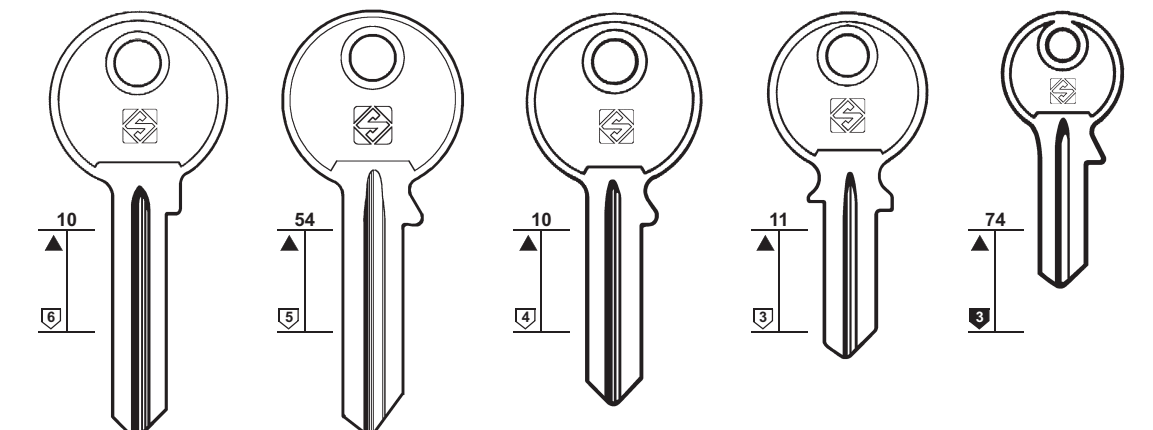

SR10R

SR4

SR11R

SR2

SR2R

SR9R



ATLAS

ATLAS - EUROP
MATTEY



164

PER / FOR

SWEDA (I)

+ PREFER (143)

+ PRIM (144)

SWISSTAC (D)

DOM (61)

TACO (USA)

SCHLAGE (151-152)

TALLIN (EST)

TAMPALINI (I)

BALLY

K+K

SAB

TF

+ MORI E. (128)

TANLOCKS (RSA)

LÄSBOLAGET (111)

TARONI (I)

PER: **SWEDA**

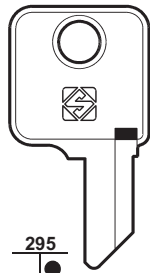

295

SW3

L



TALLIN

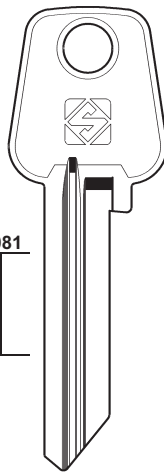

1081

BLT1R

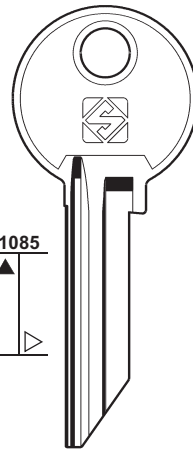

1085

TLN1

TAMPALINI

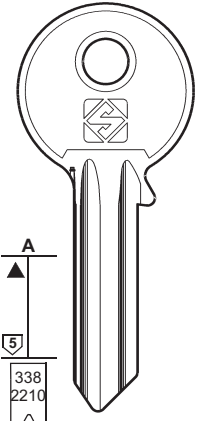

A

5

338

2210

TP1

TP1R

..... 123456

..... 12345

BALLY - K+K - SAB - TF

PER: **TAMPALINI**

FOR:

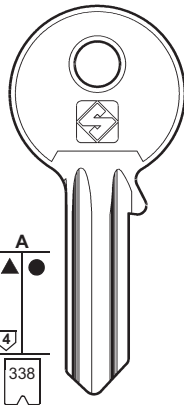

A

4

338

TP2

TP2R

..... 1-2-3-4-5-6

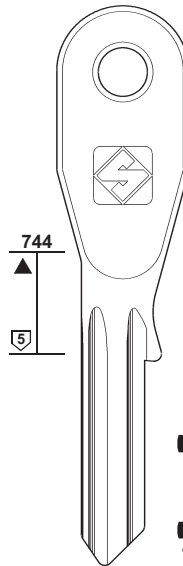

744

5

TP3

TP3R

TARONI

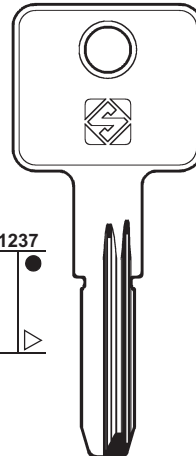

1237

TAR21

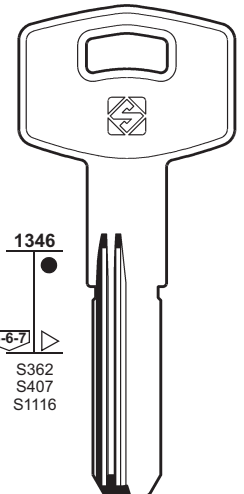

1346

5-6-7

S362

S407

S1116

TAR16



TAR16R

PER: **TARONI**

FOR:

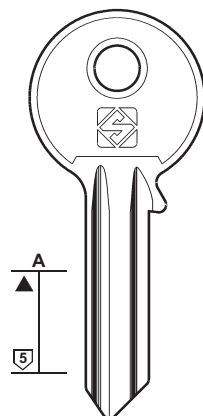

A

5

TAR4

TAR4R

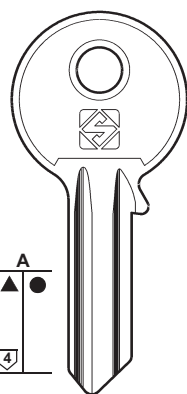

A

4

TAR5

TAR5R

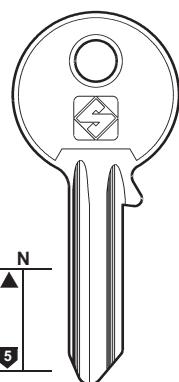

N

5

TAR8

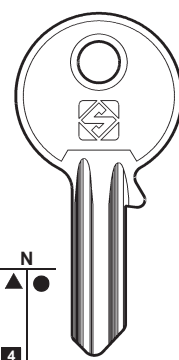

N

4

TAR3

TAR3R

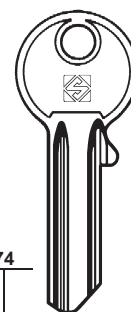

74

4

TAR1

TAR1R

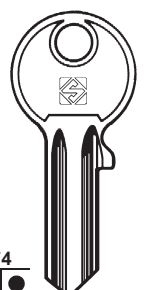







74

3

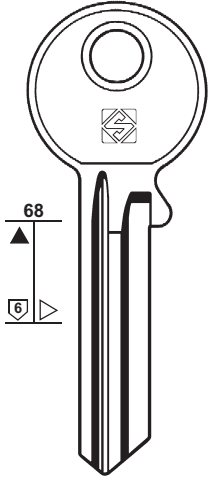
TAR2

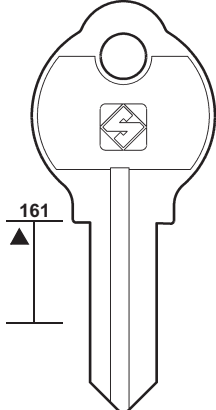
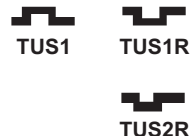
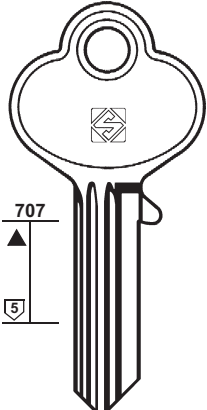
TAR2R

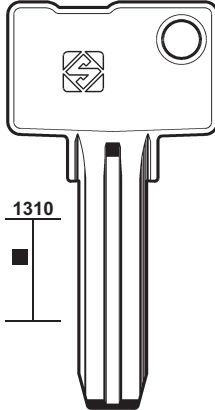



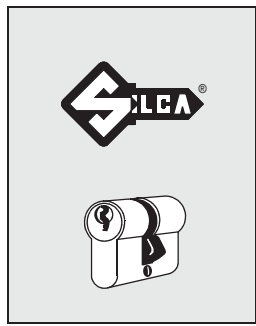





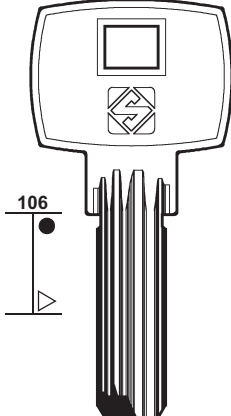

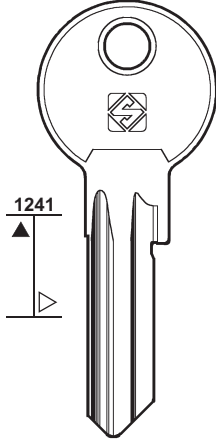
PER: FOR:	TARZEN	TAS	TAYLOR	TECSESA
	 <p>68 5</p>  <p>TKZN1</p>	 <p>161 5</p>  <p>TUS1 TUS1R TUS2R</p> <p>BIBERING - TÜRSCHLOSS</p>	 <p>707 5</p>  <p>TY1</p>	 <p>1310 5</p>  <p>TEC1</p> 

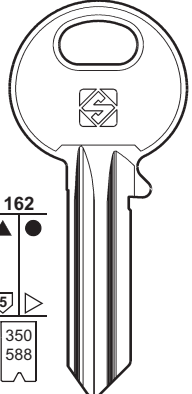

165

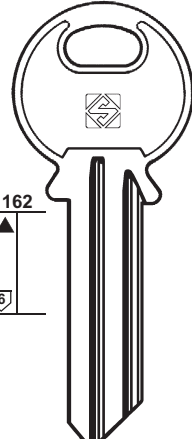
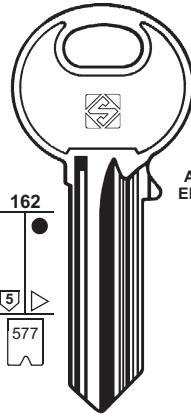
- PER / FOR
- TARZEN (RC)
 - TAS (D)
BIBERING
TÜRSCHLOSS
 - TAUB (E)
ZANETTI A. (200)
 - TAV (F)
RONIS (147)
 - TAYLOR (USA)
 - TEC (F)
STAR (161)
 - TECHNAL (D)
CAS-CISMA (40)
TESA (165)
 - TECNOR (F)
FICHET (80)
 - TECSESA (E)
 - TEEN HAAF (NL)
KIFERM (106)
 - TEGASI (GR)
 - TEICOCIL (P)
 - TEKA (S)
ASSA
ERICSSON
ERMEX
LM
+ ASSA (18)
 - TELFORD (GB)
L & F (116)
 - TEM (E)
IFAM (95)
 - TERCA (E)
AGA (11)
 - TESA (E)
ESAFE
GAINSBOROUGH
KAWE
METALUX
NINO
SOS
TECHNAL
+ ELCA (68)

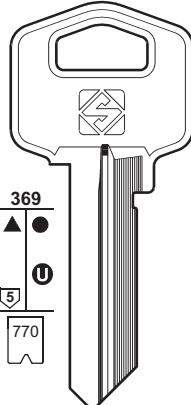
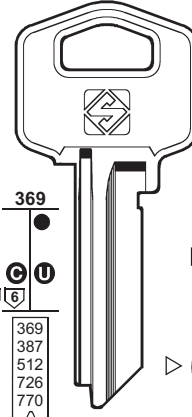
PER: FOR:	TEGASI	TEICOCIL	TEKA
	 <p>106 5</p>  <p>TGS1R</p> 	 <p>1241 5</p>  <p>TCL1</p>	 <p>162 5 350 588</p>  <p>ASS6 ● ASS6R 20201 20301 0-1-2-3-4-5-6-7-8-9-A-B-C D-0-1-2-3-4-5-6-7-8-9-A-B-C ASSA</p>

PER: FOR:	TEKA	TESA
	 <p>162 5</p>  <p>162 5 577</p>  <p>ASSA ERMEX LM TK1 20004 0123456789ABCEFG</p> <p>TK1R 20102 ASSA ERMEX LM</p> <p>TK2 21001</p> <p>TK3R 20802 ▲TK4R 21601 ▲TK4 21701 TK2R 21101</p> <p>ERICSSON</p>	 <p>369 5 770</p>  <p>369 5 369 387 512 726 770</p>  <p>TE1 ▲TE1R (TE-5) 0-9-8-7-6-5-4-3-2-1</p> <p>TE2 ESAFE (TE-5) 0987654321 0123456789 123456789 A/Z 123456789</p> <p>TE3 ▲● 123456789 A/Z 123456789</p> <p>TE6 ▲ 0987654321</p> <p>GAINSBOROUGH KAWE - METALUX NINO - SOS - TECHNAL</p>



166

PER / FOR**TESA (E)**KALE
STS
VIRO
+ ELCA (68)**TESIO (I)**

CORBIN (53)

TESTA (I)

CAS-CISMA (40)

TF (I)

TAMPALINI (164)

TH (D)H.R.S.
TRUMPF**THIRARD (F)****THÖMEE (I)**

CES (44)

THÖNE (D)

CORBIN (53)

TICINO (I)

BERTOLOTTI

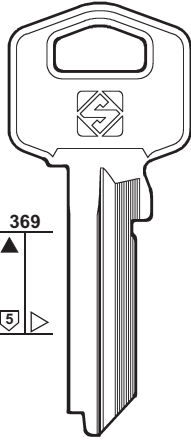
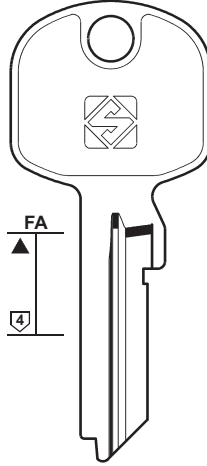
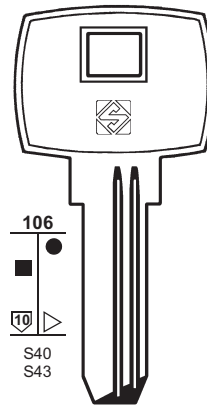
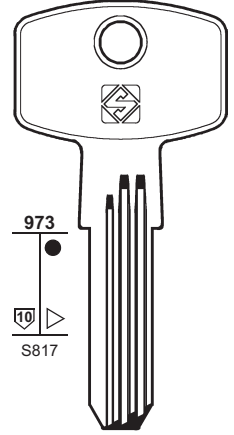
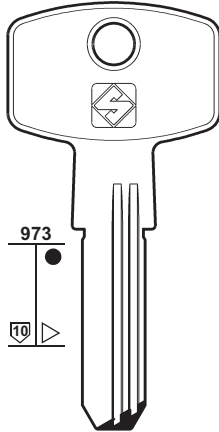
TIEFENTHAL (D) CISA (48)
 ELZETT (68)
 EMR (69)
 GTV (90)
 JOWIL (100)**TIFON (RC)**PER:
FOR:**TESA****TE2X****TE8XFA****TE4 TE4R**
T-10**STS****TE16**
T-10PPER:
FOR:**TESA****EC5**

KALE - STS - VIRO

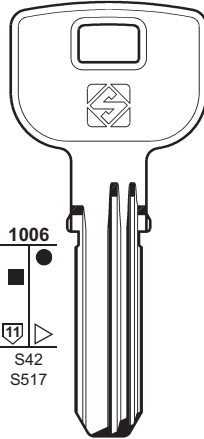
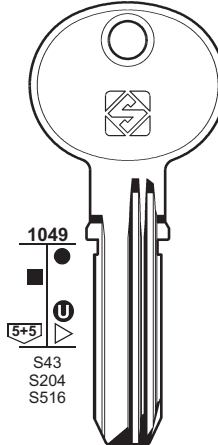
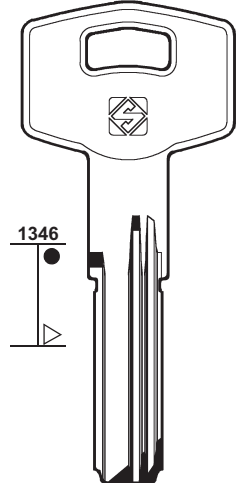
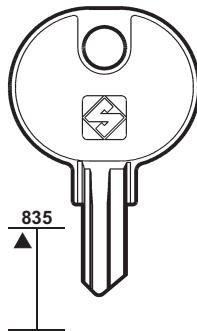
**TE5 TE9**
T-80 T80/SC**STS****TE7**
T-60**STS****TE19**PER:
FOR:**TH****THIRARD****TICINO****TIFON****THA1**

H.R.S. - TRUMPF

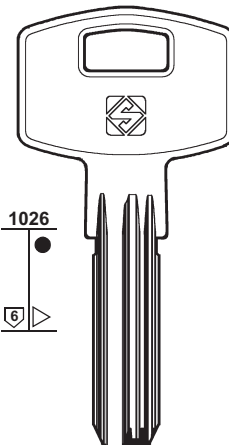
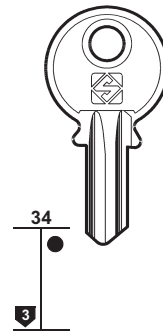
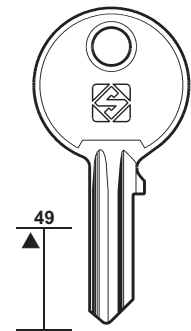
**THR1****TC1 TC1R****BERTOLOTTI****TFN1 TFN2**

PER: FOR:	TIGRIS	TIK	TITAN	



167

PER / FOR
TIGRIS (GB)
TIK (GB)
TITAN (SLO)
TITAN (SLO) EMKA GIUSSANI LAMA PICARDIE

PER:
FOR:

TITAN

	 123456789	
			PICARDIE

PER:
FOR:

TITAN

T100		EMKA GIUSSANI
		LAMA



168

PER / FOR

TITAN (SLO)
FTH
VACHETTE

TITUS (GB)
W.M.S. (192)

TM (D)
DOM (61)

TOKOZ (CZ)

TOK-TRELOCK (D)

TOK-WINKHAUS (D)
MASTER

PER:
FOR:

TITAN

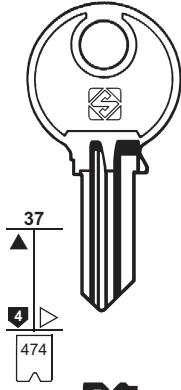

TN9
... 251-300

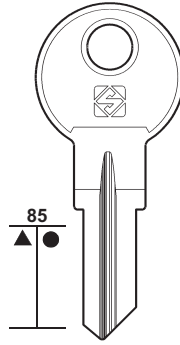

TN10

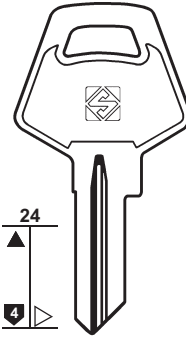

TN6R

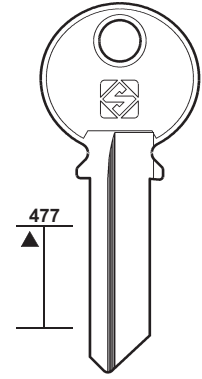

TN11R



TN14

FTH
VACHETTE

PER:
FOR:

TITAN

TOKOZ

TOK-TRELOCK

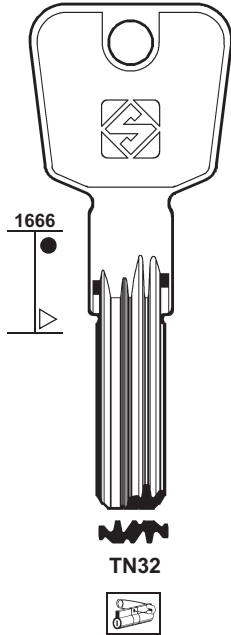

TN32

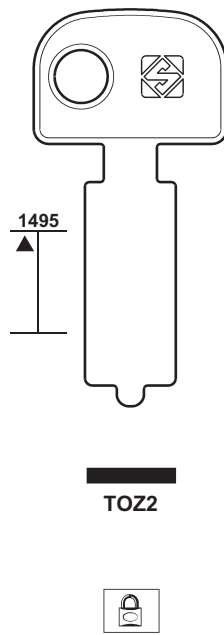

TO2

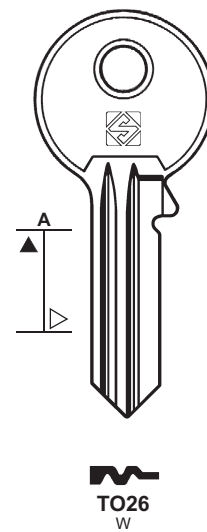

TO26
W

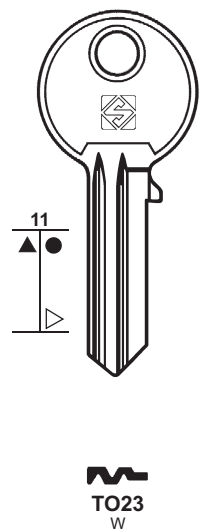

TO23
W

PER:
FOR:

TOK-TRELOCK

TOK-WINKHAUS

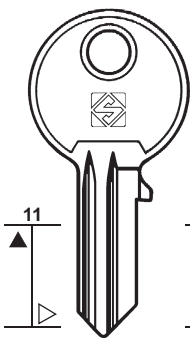

TO24
W

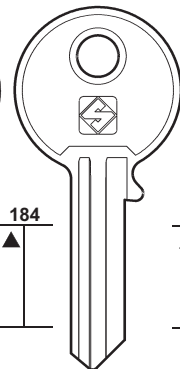

TO44

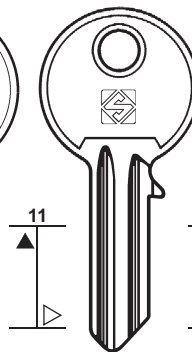

TO22

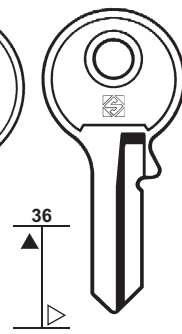

TO12

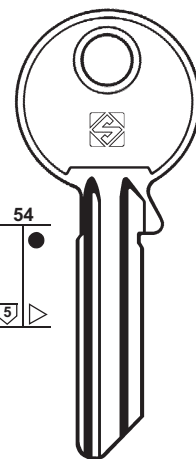

TO29

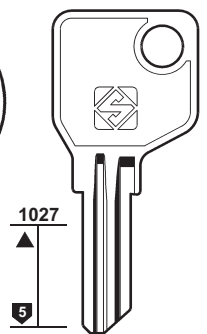

TO92R

TO66



PER:
FOR:

TOK-WINKHAUS

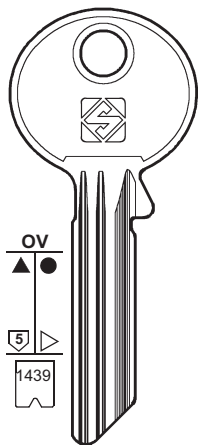

X.....
0-1-2-3-4-5-6

	TO8X1		TO8RX1		TO8X7		TO8RX7		TO8X13 DISQUIN		TO8RX13
	TO8X2		TO8RX2		TO8X8		TO8RX8		TO8X14		TO8RX14
	TO8X3		TO8RX3		TO8X9		TO8RX9		TO8X15		TO8RX15
	TO8X4		TO8RX4		TO8X10		TO8RX10		TO8X16		TO8RX16
	TO8X5		TO8RX5		TO8X11		TO8RX11		TO8X17		TO8RX17
	TO8X6		TO8RX6		TO8X12		TO8RX12		TO8X18		TO8RX18



169

PER / FOR

TOK-WINKHAUS (D)
DISQUIN

PER:
FOR:

TOK-WINKHAUS

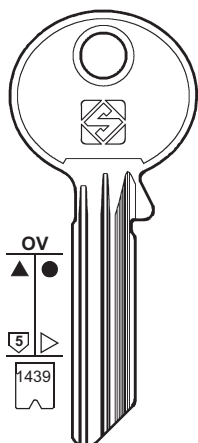

Y.....
0-1-2-3-4-5-6

	TO9Y1		TO9RY1		TO9Y7		TO9RY7		TO9Y13		TO9RY13
	TO9Y2		TO9RY2		TO9Y8		TO9RY8		TO9Y14		TO9RY14
	TO9Y3		TO9RY3		TO9Y9		TO9RY9		TO9Y15		TO9RY15
	TO9Y4		TO9RY4		TO9Y10		TO9RY10		TO9Y16		TO9RY16
	TO9Y5		TO9RY5		TO9Y11		TO9RY11		TO9Y17		TO9RY17
	TO9Y6		TO9RY6		TO9Y12		TO9RY12		TO9Y18		TO9RY18

PER:
FOR:

TOK-WINKHAUS

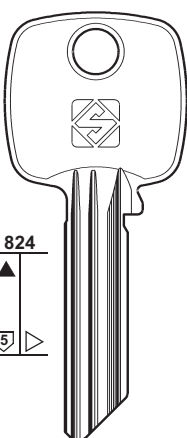

	TO50X1		TO50X9		TO50RX9
	TO50X2		TO50RX2		TO50X10
	TO50X3		TO50X11		
	TO50X4		TO50RX4		TO50X13
	TO50X5		TO50RX5		TO50X14
	TO50X6		TO50RX6		TO50X15
	TO50X7		TO50RX7		TO50X17
	TO50X8		TO50X18		

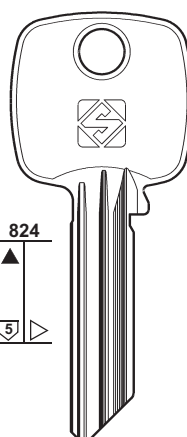

	TO51Y1		TO51RY1
	TO51Y2		TO51RY2
	TO51Y3		TO51RY3
	TO51Y5		TO51RY4
	TO51Y6		TO51RY5
	TO51Y7		TO51RY6
	TO51Y8		TO51RY7
	TO51Y9		



170

PER / FOR

TOK-WINKHAUS (D)
COMBA
EGSA
SIEBAU
TRELOCK
VACHETTE

PER:
FOR:

TOK-WINKHAUS

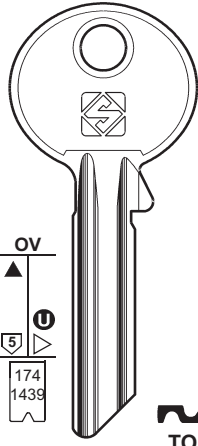

TO54-1	TO54-2	TO54-3	TO54-4
TO54-5	TO54-6	TO54-7	TO54-8
TO6 9	TO5 Z.....0123456	TO3 11	TO4 12
TO54-13	TO54-14	TO7 15	TO54-16
TO54-17	TO54-18	TO54-19	TO54-20
TO1	TO54-21	TO2 22	TO54-23
TO15	TO16	TO17 EGSA	TO75R
TO25R	TO28R	TO31R	TO82R

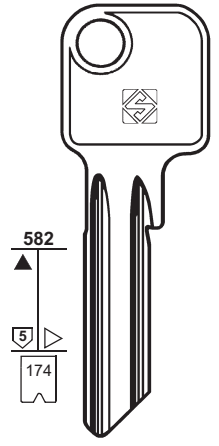
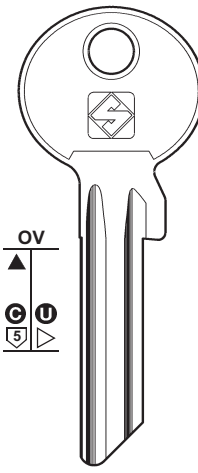

TO1X

TO10
P.....
0-1-2-3-4-5-6-7-8
TRELOCK

PER:
FOR:

TOK-WINKHAUS

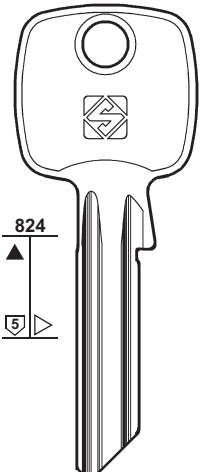
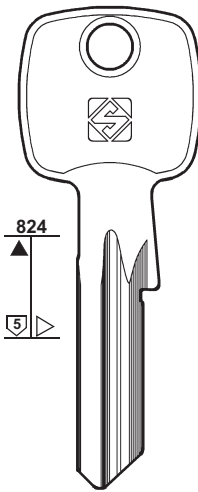
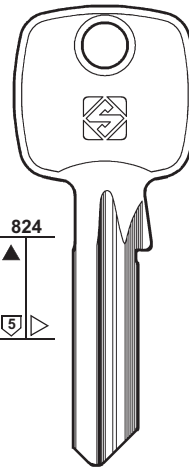
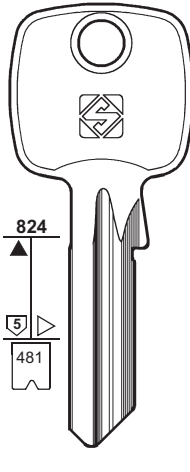
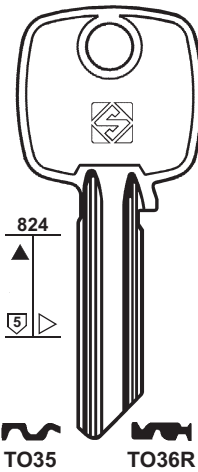

TO35

TO36R

TO41R

TO114RX
9.....X
012345678

TO124RX

TO120RX

TO125X

PER:
FOR:

TOK-WINKHAUS

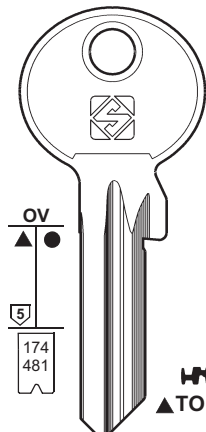
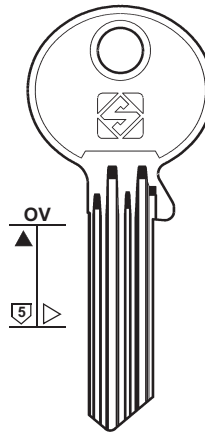
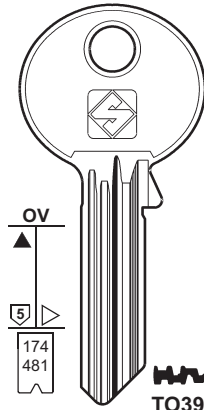
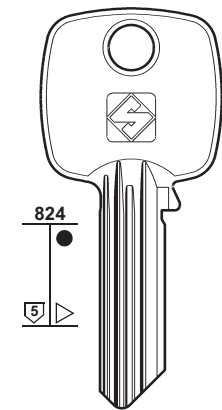

TO40

TO42R

9 TO30
9.....T
012345678

TO30R
9.....X
012345678

TO81R

TO30X
9.....T
012345678

TO30RX
9.....X
012345678

TO34

PER:
FOR:

TOK-WINKHAUS

TO27▲●
0123456789

TO18

TO19

TO20R

TO33

TO55 FAABF

TO57 EHBA EKCP

TO58 EFAM EFWS

TO59 EWSB

TO60 BFA2

TO61 BFA3

TO64 BYNY1

TO65

TO107

TO91

TO111R

TO100

TO127

TO106

TO105

AZBE

AZBE

BIFFAR - FICHET



171

PER / FOR

TOK-WINKHAUS (D)
AZBE
BIFFAR
EFAM
EGSA
ENAX
FICHET

TOP (D)
ABUS
NOVA
+ 👁 ABUS (6)
+ 👁 WILKA (191)

TOR (I)
👁 ZANETTI A. (200)

TORE (D)
👁 CES (42)

TOUCH (GB)

TOVER (E)
MASTER
TROMER
+ 👁 FTH (81)

TRABER (GB)
👁 EURO LOCKS (71)

PER:
FOR:

TOP

TOUCH

TOP1R

TOP1RX

ABUS - NOVA

TOU1R
..... 12345

TOU2R
..... 12345

TOU3R
..... 12345

PER:
FOR:

TOVER

TV1

TV2
2F-35

TV3
2F-25

TV4

MASTER

TROMER



172

PER / FOR

TRAINS (RC)

TRAU (I)
PREFER

TRELOCK (D)
WASO

+ TOK-TRELOCK (168)
+ TOK-WINKHAUS (170)

TRI-CIRCLE (RC)
ABUS
ELEPHANT

+ DOUBLE CIRCLE (67)

PER:
FOR:

TRAINS

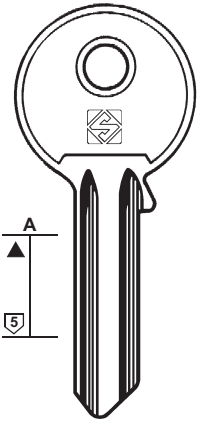

TS1

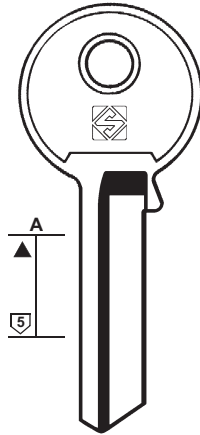

TS2

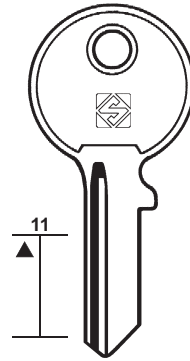

TS3

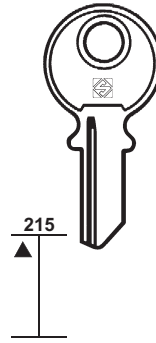

TS4

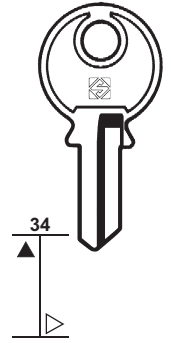

TS5



PER: **TRAU**
FOR:

TRELOCK

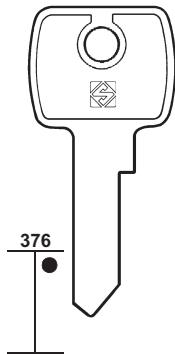

TRU1R



PREFER

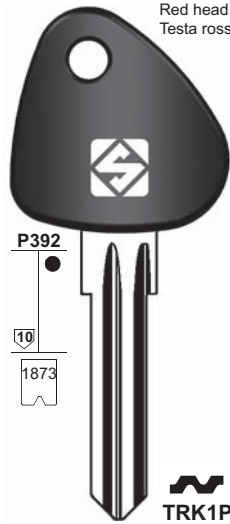

TRK1P

R6
0-1-2

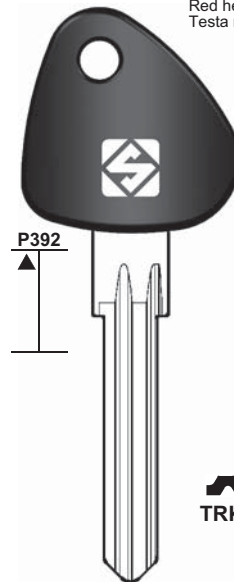

TRK7P

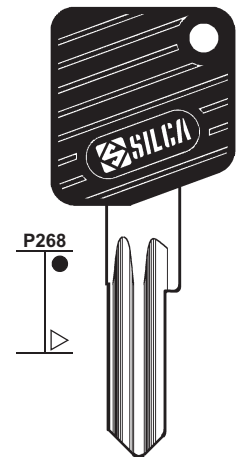
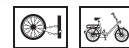

TRK4CP

WASO

PER:
FOR:

TRI-CIRCLE

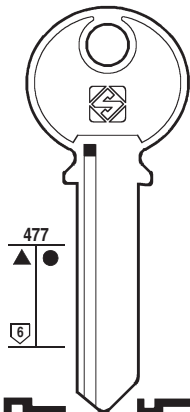

TL3 **TL3R**
1C 1A

TL8 **TL8R**
1D 1B



mm 65

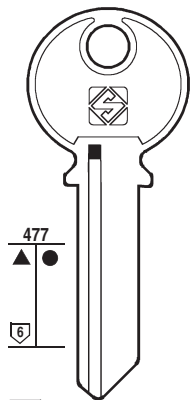

TL2 **TL2R**
2D 2B

TL5 **TL5R**
2C 2A



mm 50

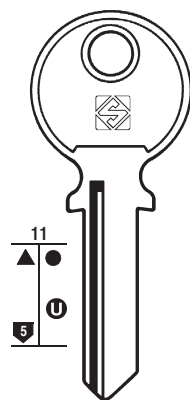

TL1 **TL1R**
3C 3A

TL4 **TL4R**
3D 3B



mm 40

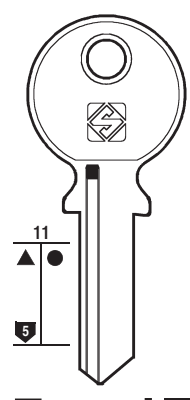

TL6 **TL6R**
4C 4A

TL7 **TL7R**
4D 4B



mm 40

ABUS - ELEPHANT

PER:
FOR:

TRI-CIRCLE

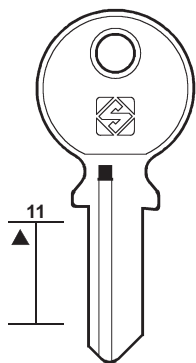

TL15

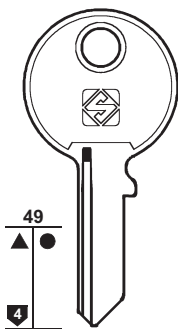

TL9
5C
YONGTAI

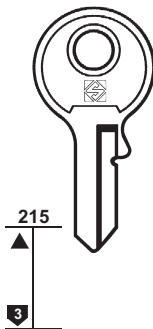

TL12R

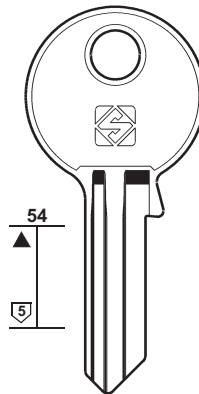

TL14

TL9R
5A

TL10
5D
TL10R
5B
ABUS - MARK



173

PER / FOR

TRI-CIRCLE (RC)
ABUS
MARK
YONGTAI
+ DOUBLE CIRCLE (67)

TRIO (N)
 TRIOVING (173)

TRIOVING (N)
TRIO

PER:
FOR:

TRI-CIRCLE

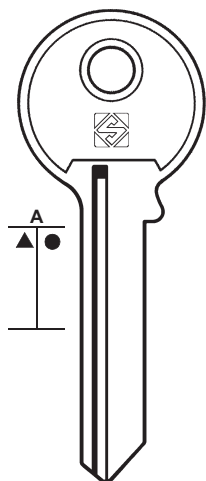

TL11 TL11R

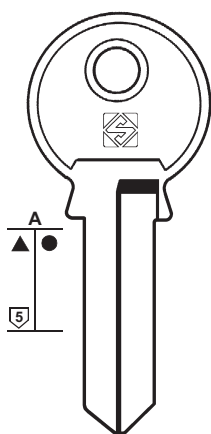

TL13



TRIOVING

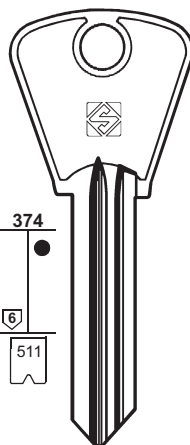

TR1

0-1-2-3-4-5-6-7-8-9-A

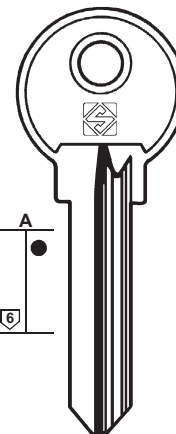

TR2

TRIO

PER:
FOR:

TRIOVING

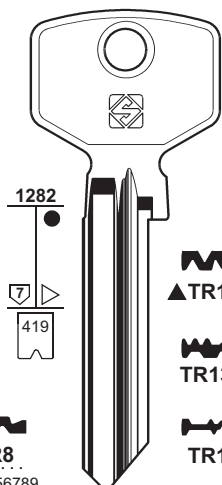

TR8
0123456789

TR9

TR10

TR16

TR13R

TR12

TR11R

TR10R

TR19R

TR18R

TR17R

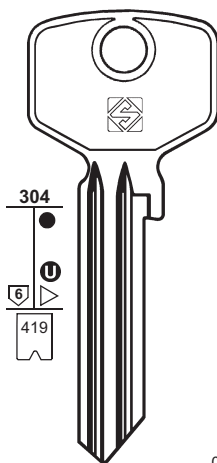

TR4

..... 0123456789
..... NK 1-18342
..... 1-26770
..... 30000-56769
..... ND 1-99999
D 1-13278
DCN -82660
..... 1-13278
..... 1-26770

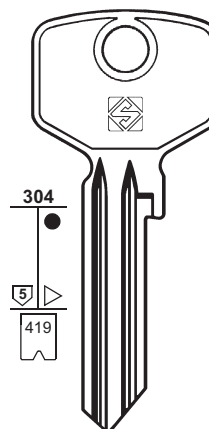

TR5

TR3

0-1-2-3-4-5-6-7-8-9



174

PER / FOR

TRIOVING (N)

TRI STAR (RC)

TRITON (D)

• CES (42)

• JOWIL (100)

TROMER (E)

• MCM (121)

• TOVER (171)

TRUMPF (D)

• TH (166)

TRYBA (A)

• EVVA (72)

TULA (RUS)

TUSHINO (RUS)

TÜRSCHLOSS (D)

• TAS (165)

TWINLOCK (GB)

TWIRHONB (F)

• ASIA (18)

TZAFRER (GR)

+ • CISA (48)

+ • GEGE (84)

UAP (GB)

PER:
FOR:

TRIOVING

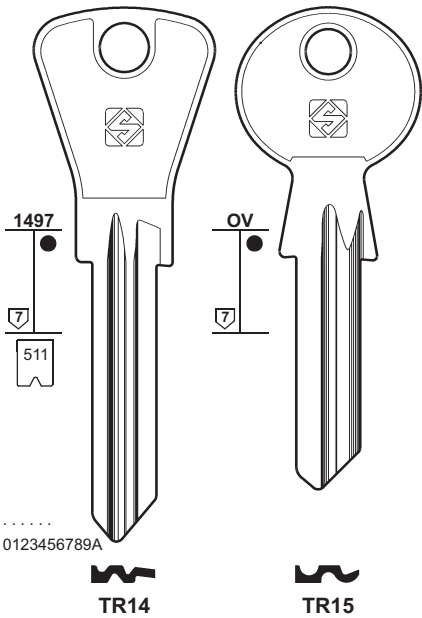

TRI STAR

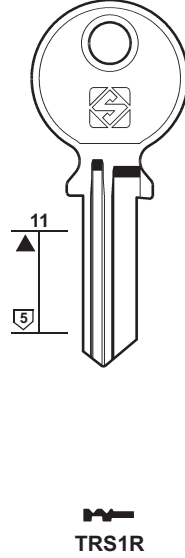

TULA

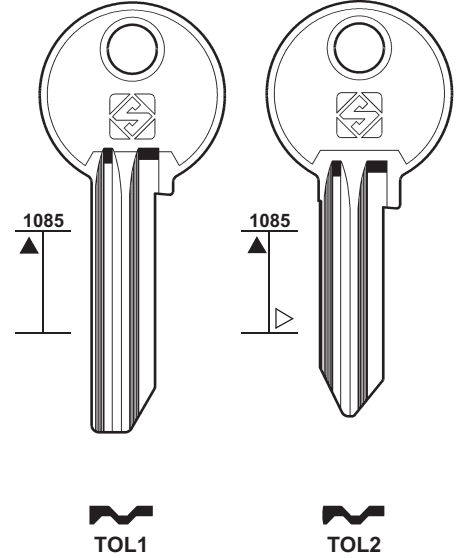

PER:
FOR:

TUSHINO

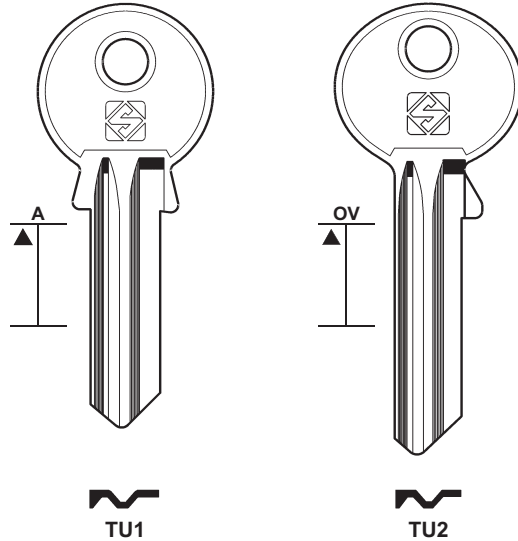

TWINLOCK

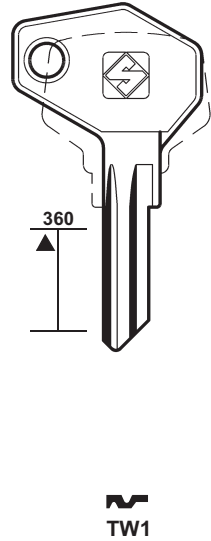

PER:
FOR:

TZAFRER

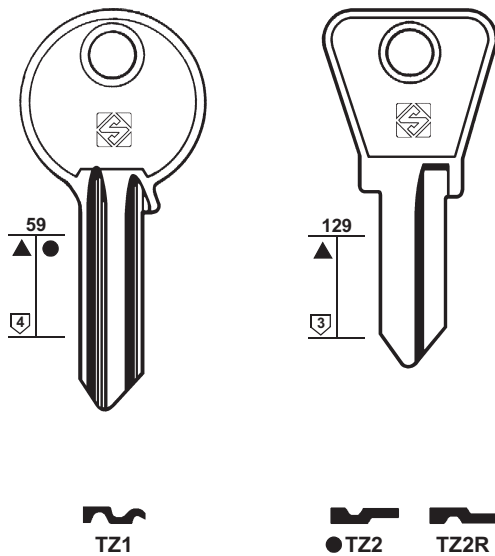

UAP

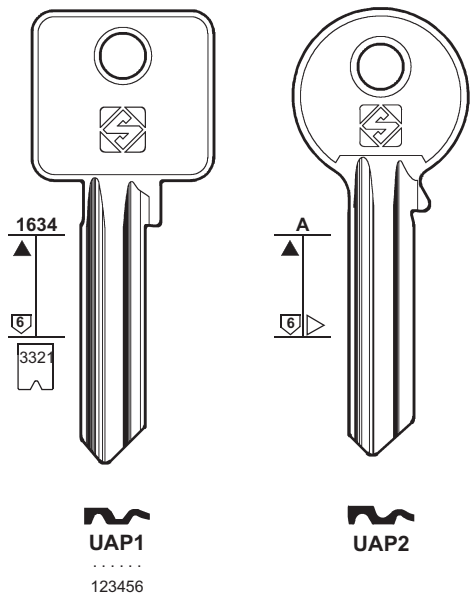

PER:
FOR:

UCEM

29
811

1204

P244
S170
S196

1203
S170
S196

1203

UC2

UC1 UC1R

UC6R

UC3RP
2000S

UC5R

UC4R

CIB - RIV

ESAFE - ISEO
YEMAR

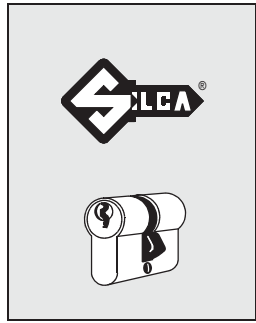

175

PER / FOR

UCEM (E)
CIB
ESAFE
ISEO
RIV
YEMAR

UEME (BR)

ULIANOVSK (RUS)

ULTRA (GB)
L & F (116)

UMF (P)
+ YALE (193)

UNIFERRO (F)
CISA (48)

UNIFOR (I)
PREFER (142)

PER:
FOR:

UCEM

1386

UC8R

PER:
FOR:

UEME

1156

1156

1292

UE5R

UE4R

UE2R

PER:
FOR:

UEME

1292

UE3R

PER:
FOR:

ULIANOVSK

1088

ULS1R

PER:
FOR:

UMF

54

A

UM1

UM2



176

PER / FOR

UNION (GB)
HENDERSON
ONIUN

PER:
FOR:

UNION

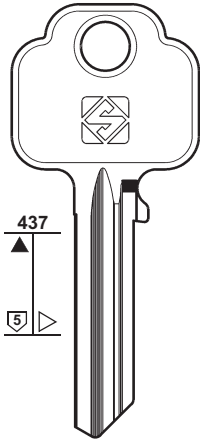

UNI66R B-MLA
UNI68R NE

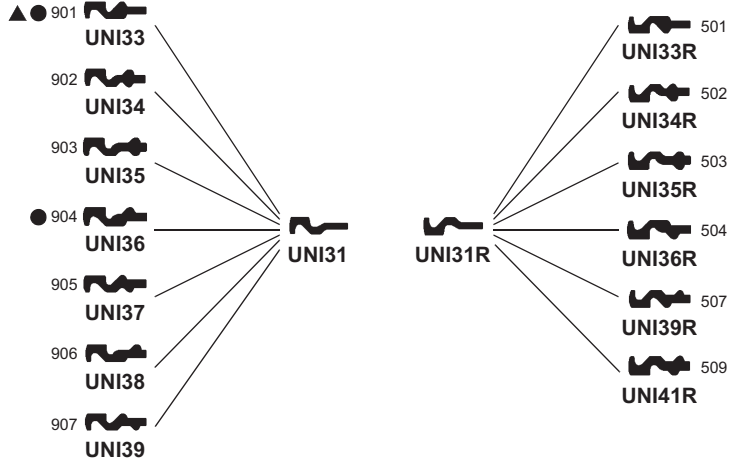

PER:
FOR:

UNION

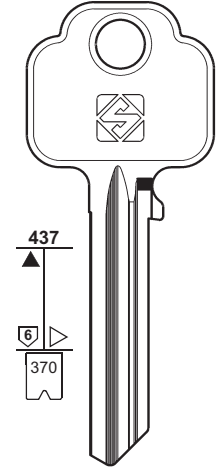

UNI67R B-MLA

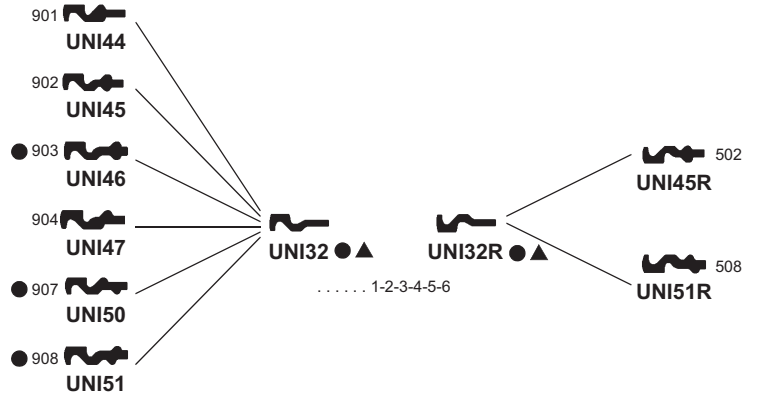

PER:
FOR:

UNION

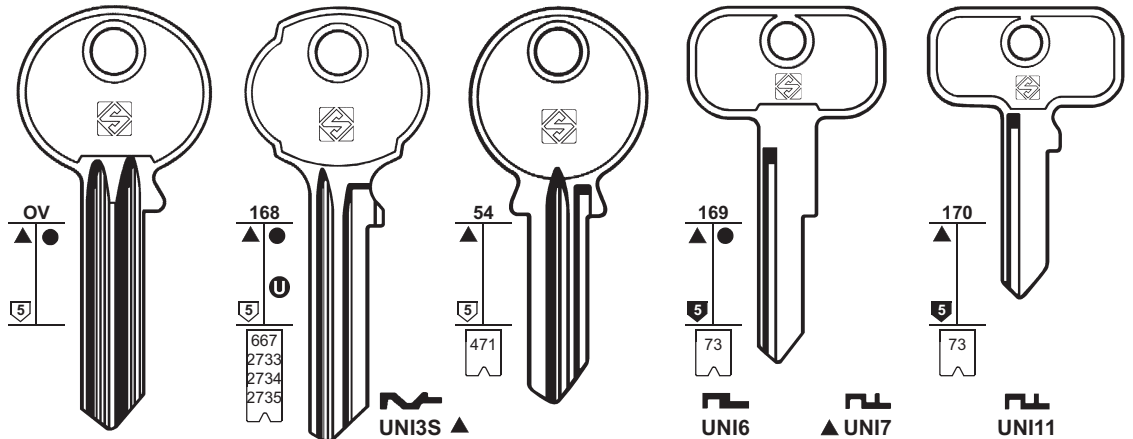

UNI28 KB506
UNI3 KB502
UNI3S
UNI54R ZA1
UNI18 NJ
UNI6
UNI16
UNI17
UNI16R
UNI11
UNI14

ONIUN

PER:
FOR:

UNION

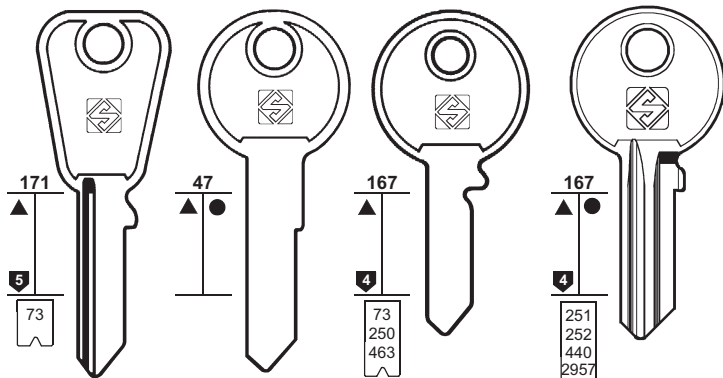

NKL ... 151-300
NND ... 151-300
TBS ... 201-350



UNI22

NKW/A ... 1001-1100
NKW/A ... 1-100
NKW/X ... 1-100
NKW/H ... 1-50
NKL ... 301-450
NND ... 1-150
NND ... 301-450
NPK ... 1-100



UNI23

TBS ... 1-100
NKL ... 1-150
NND ... 1-150
TBS ... 1-50
TBS ... 101-200
TBS ... 201-300
TBS ... 201-350
TBS ... 301-400
TBS ... 401-500



UNI30



UNI61R

TBS ... 201-350
RV ... 1-450



UNI57R

NKW/X ... 101-200
NKW/A ... 101-200
NKW/A ... 1101-1200



UNI61

UNI12
FP ... 626-750

UNI29
KB682

UNI4
NRA

UNI4R
EJR ... 1-75

UNI27
KB53A

UNI5
NGN ... 1-54

UNI63

UNI15
... 1-99
FS ... 1-99
FS ... 876-955

FFE ... 1-100
FL ... 251-500
NRA ... 51-90
FG ... 1-30
NF ... 1-30
EJR ... 1-75
FMO ... 1-75



177

PER / FOR

UNION (GB)

UNIVERSAL

PER:
FOR:

UNIVERSAL SERIE DISTINZIONE

HEAD TYPE / TESTA TIPO **N**

HEAD TYPE / TESTA TIPO **A**

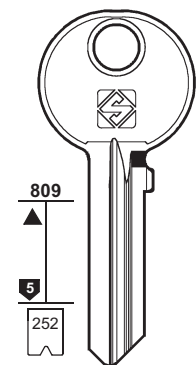

UNI59R
NKW/A ... 1-100
NKW/A ... 1001-1100
NPK ... 1-100

UNI60R
NKW/X ... 201-300
NKW/A ... 201-300

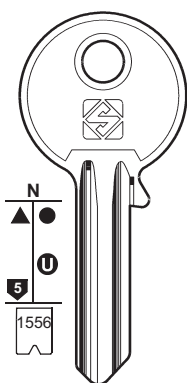

UL058
... 123456

UL059

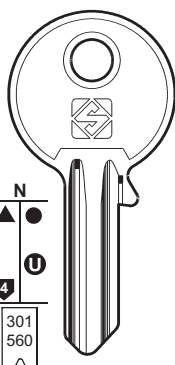

UL060
... 501-700
... 1001-1500

UL061

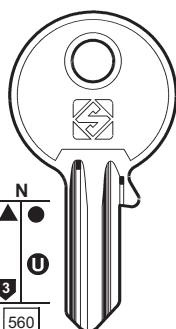

UL056
... 1701-1810
... T 1-113

UL057▲●

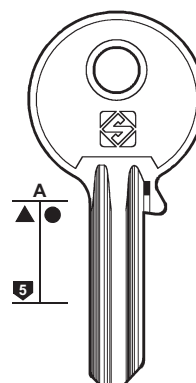

UL058A

UL059A

PER:
FOR:

UNIVERSAL SERIE DISTINZIONE

HEAD TYPE / TESTA TIPO **A**

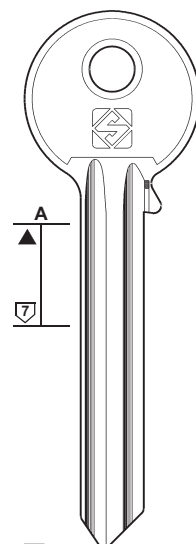

UL046

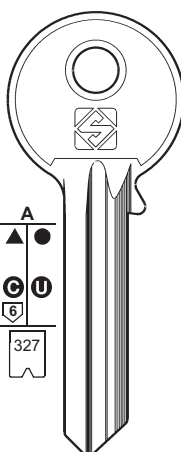

UL047

UL055

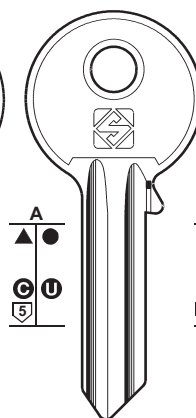

UL050

UL051

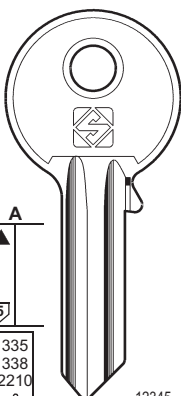

UL062

UL063

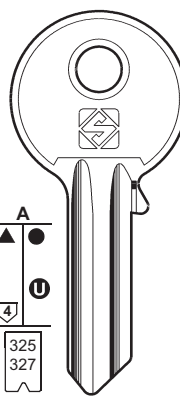

UL052 ... 0123456789
... 123456

UL053 ... 123456

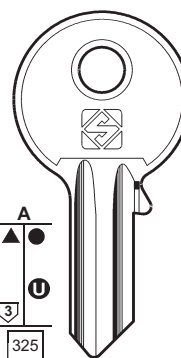

UL048

UL049



178

PER / FOR
UNIVERSAL

PER:
FOR:

UNIVERSAL SERIE DISTINZIONE

HEAD TYPE / TESTA TIPO **B**

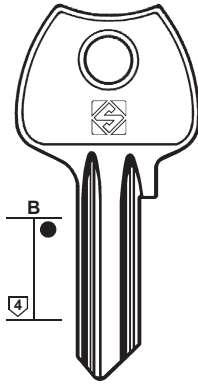
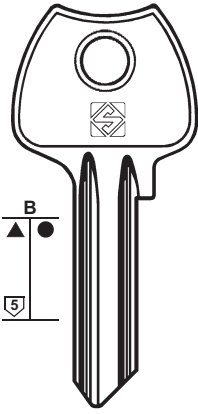

HEAD TYPE / TESTA TIPO **C**

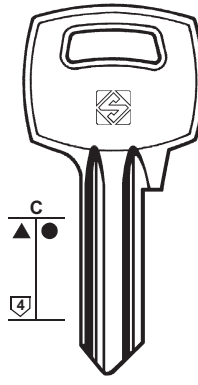
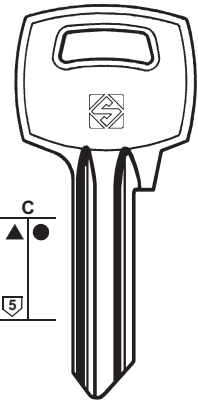

PER:
FOR:

UNIVERSAL SERIE DISTINZIONE

HEAD TYPE / TESTA TIPO **D**

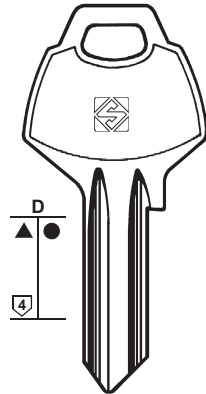
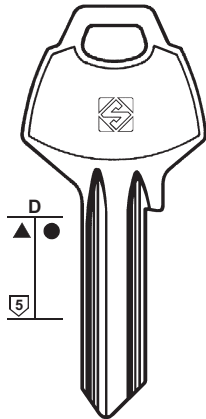

HEAD TYPE / TESTA TIPO **E**

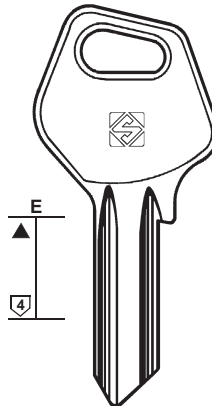
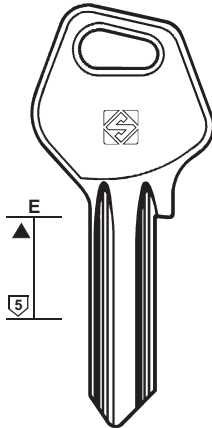

PER:
FOR:

UNIVERSAL SERIE DISTINZIONE

HEAD TYPE / TESTA TIPO **F**

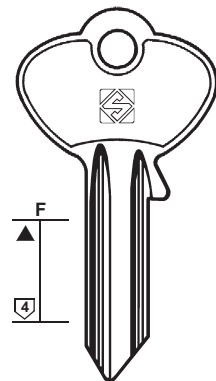
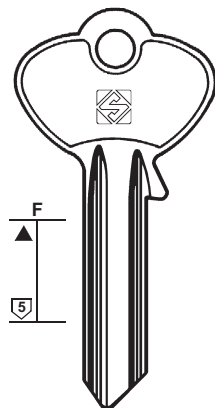

HEAD TYPE / TESTA TIPO **G**

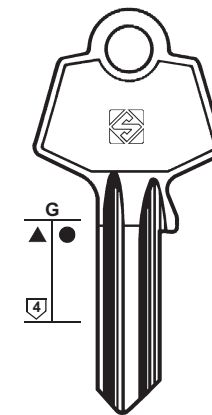
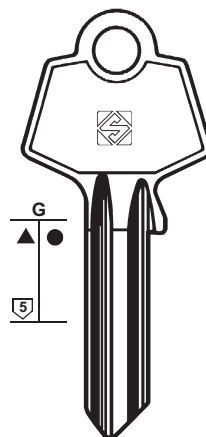

PER:
FOR:

UNIVERSAL SERIE DISTINZIONE

HEAD TYPE / TESTA TIPO **H**

HEAD TYPE / TESTA TIPO **L**

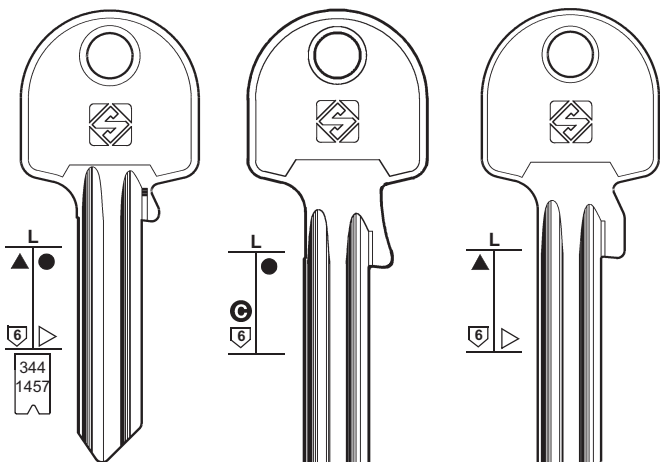
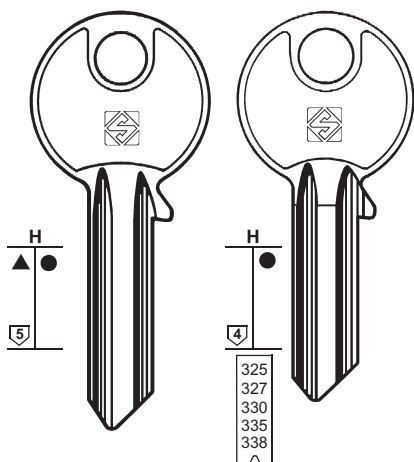

UL050H

UL052H

UL054L

UL054SL

UL054XL

- 012345678
- 0123456789
- 12345
- 123456

- 344
- 1457
- 12345678
- **UL055L** 123456789

- 12345678
- 123456789

- 12345678
- 123456789



179

PER / FOR

UNIVERSAL

PER:
FOR:

UNIVERSAL SERIE DISTINZIONE

HEAD TYPE / TESTA TIPO **L**

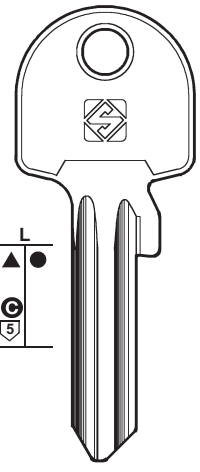
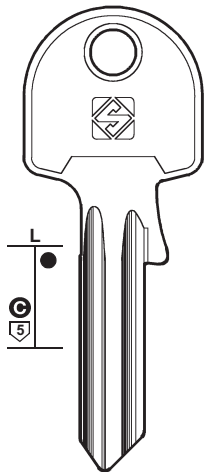
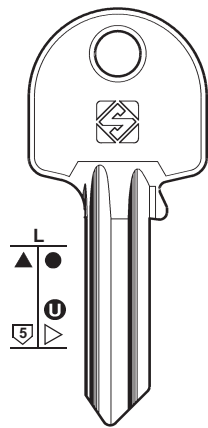

UL050L

UL050SL

UL050XL

● **UL051L**

UL051SL

● **UL051XL**

PER:
FOR:

UNIVERSAL SERIE DISTINZIONE

HEAD TYPE / TESTA TIPO **L**

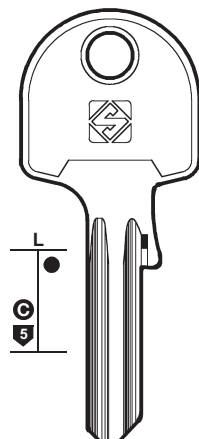
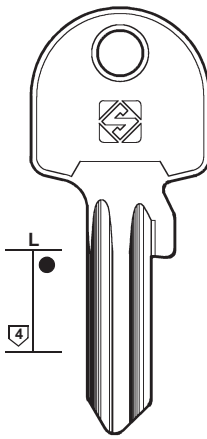
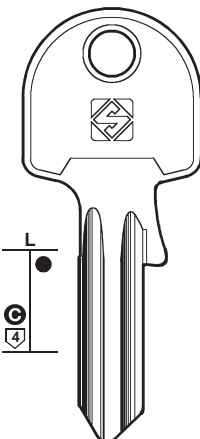
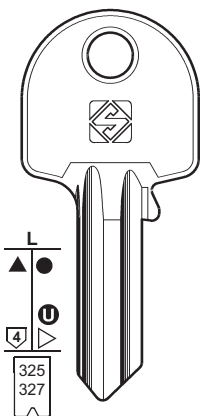

UL052L 0123456789
..... 123456

UL052SL

UL052XL

UL058SL

▲ ● **UL053L** 123456

UL053SL



180

PER / FOR

UNIVERSAL

U.P.R. (D)

URBIS (R)
BSS
YALE

URKO (E)

UTZ (CH)

👁️ FORT (81)
👁️ L & F (116)
👁️ SIS (156)

VACHETTE (F)

ISEO
KILT
SANPEUR
+ 👁️ ISEO (98)
+ 👁️ KWIKSET (108)
+ 👁️ TITAN (168)
+ 👁️ TOK-WINKHAUS (170)
+ 👁️ VEGA (185)

PER:
FOR:

UNIVERSAL SERIE DISTINZIONE

HEAD TYPE / TESTA TIPO **M**

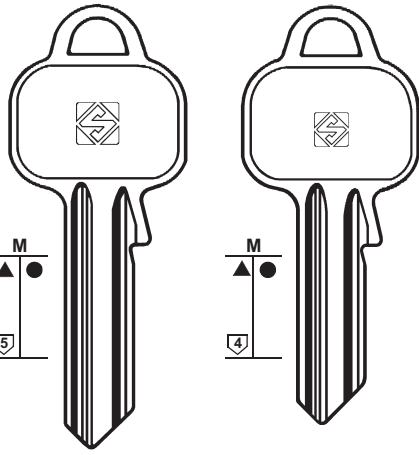

UL050M

UL052M

UL051M

UL053M

HEAD TYPE / TESTA TIPO **OV**

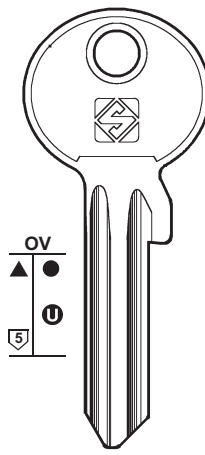

UL050X

UL051X

HEAD TYPE / TESTA TIPO **Y**

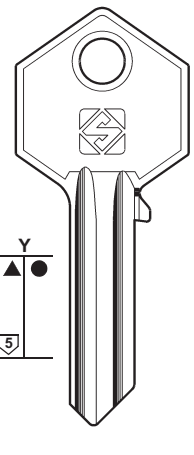

UL050Y

UL051Y

PER:
FOR:

U.P.R.

URBIS

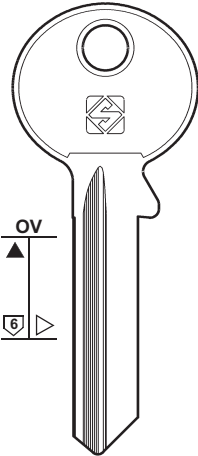

UP1

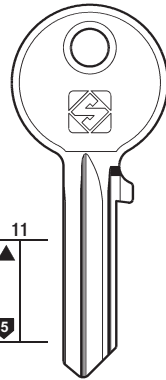

UB1R

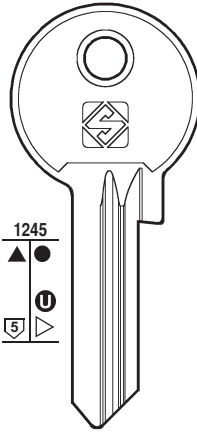

UB2R

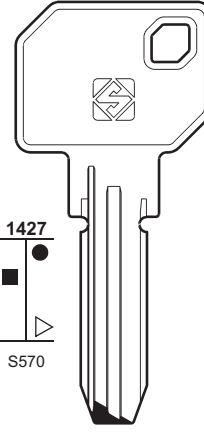

UB3

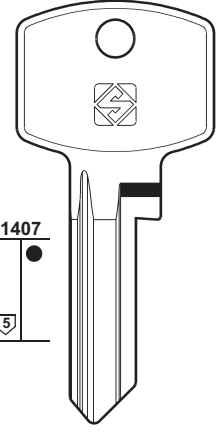

UB5

YALE



BSS - YALE

PER:
FOR:

URKO

VACHETTE

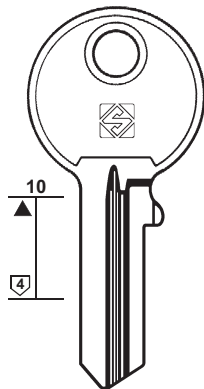

UR1

UR1R

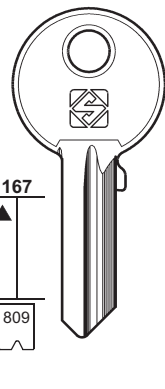

UR2

UR2R

1-2-3-4-5-6

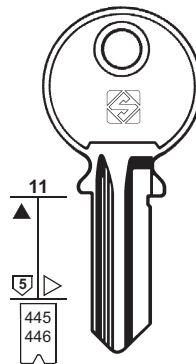

VAC46

..... 1-2-3-4-5-6-7-8
B..... 1-2-3-4-5-6-7-8
..... E 1-2-3-4-5-6-7-8-9-0



mm 40-50-60

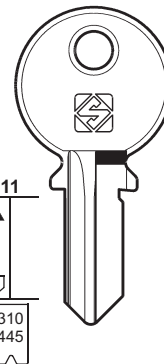

VAC1

VAC1R

E..... 9001-9100
..... E 300-499
..... R 9001-9100
..... 1-2-3-4-5-6-7-8-9-0
..... 1-2-3-4-5-6-7-8-9-0
..... E 1-2-3-4-5-6-7-8-9-0



mm 30

ISEO - KILT

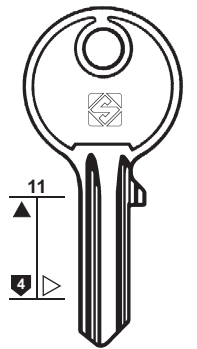

VAC8

VAC8R



SANPEUR

PER:
FOR:

VACHETTE

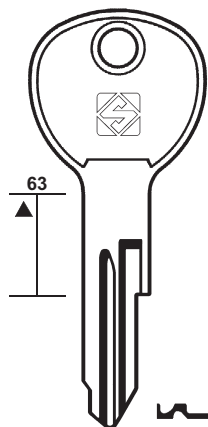

VAC44R

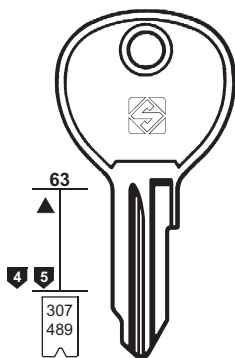

VAC25
R... 0-423



VAC25R
G... 0-423
D... 0-321

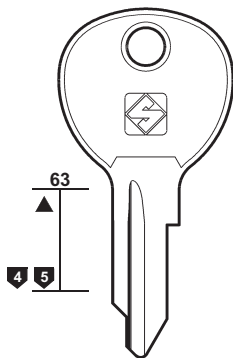

VAC106
RS



VAC106R
GS

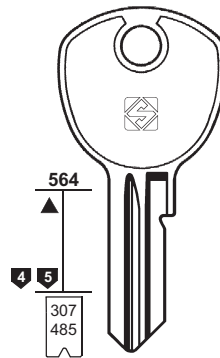

VAC65
R... 0-423
G... 600-644



VAC65R
G... 0-423
R... 600-644



VAC100



VAC100R



VAC33
V... 0-423



VAC33R
W... 0-423



VAC107
VS



VAC107R
WS



VAC66
V... 0-423
V... 600-644



VAC66R
W... 0-423
W... 600-644

VINCO

ATAL - VINCO

ATAL - VINCO



181

PER / FOR

VACHETTE (F)

ATAL
DAD
FONTAINE
HEMA
JU
METALUX
MODERN BAU
RUKA
RONIS
VINCO

- + ISEO (98)
- + KWIKSET (108)
- + TITAN (168)
- + TOK-WINKHAUS (170)
- + VEGA (185)

PER:
FOR:

VACHETTE

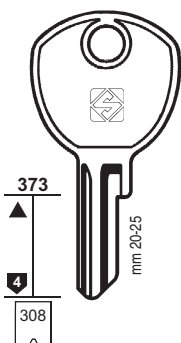

VAC42
BL... (G) A0-H9
K... A0-H9
LB... 0-49
LG... 0-49



VAC42R
RL... A0-H9
LR... (G) 0-49

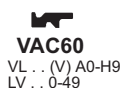

VAC60
VL... (V) A0-H9
LV... 0-49



VAC60R
WL... (W) A0-H9
LW... 0-49



DAD - JU

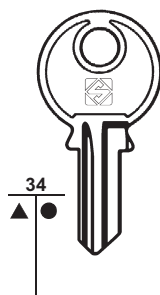

VAC11

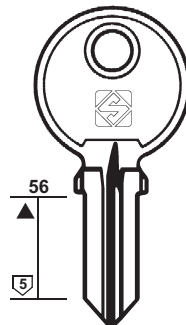

VAC10

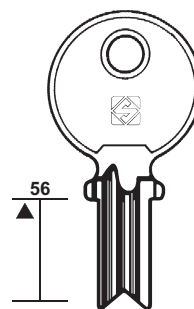

VAC41



RUKA



PER:
FOR:

VACHETTE

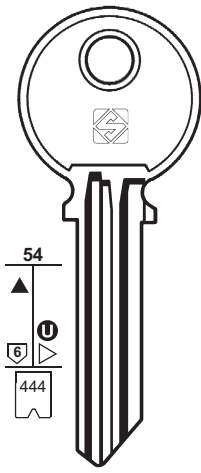

RO41

... 1-1296
... 1-2-3-4-5-6-7-8-9-0
V20... 1-1296
A/Z 1-2-3-4-5-6-7-8-9-0



DAD - RONIS

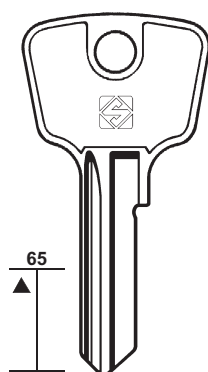

VAC14



mm 40-50-60

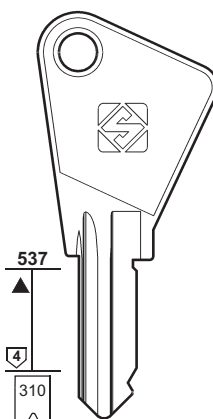

VAC61

EE... 9001-9100
E... 2-3-4-5-6

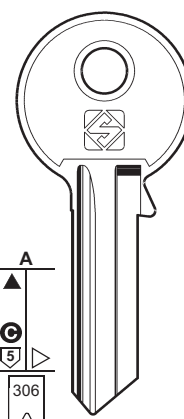

VAC29

A1... 5001-5631

FONTAINE - HEMA
METALUX - MODERN BAU

PER:
FOR:

VACHETTE



183

PER / FOR

- VACHETTE (F)**
 + ISEO (98)
 + KWIKSET (108)
 + TITAN (168)
 + TOK-WINKHAUS (170)
 + VEGA (185)

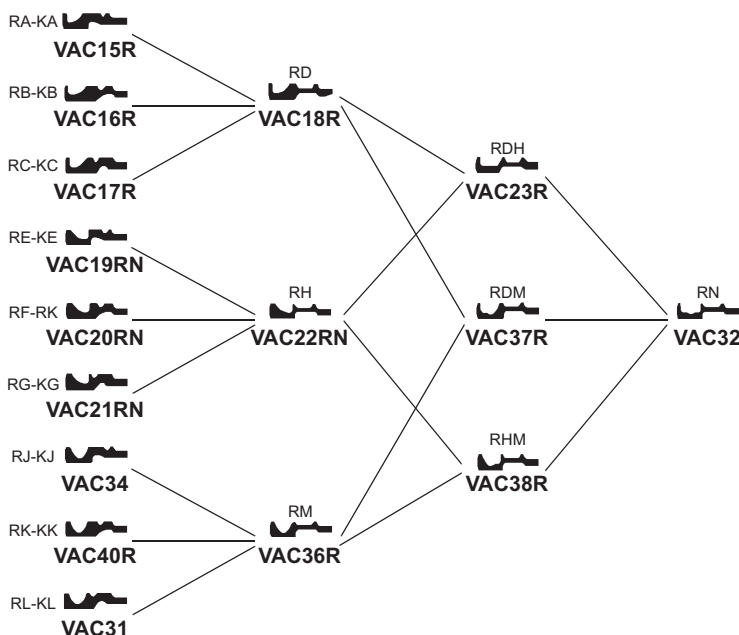
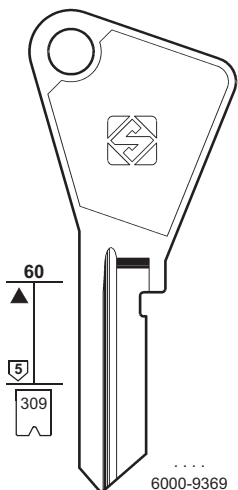

PER:
FOR:

VACHETTE

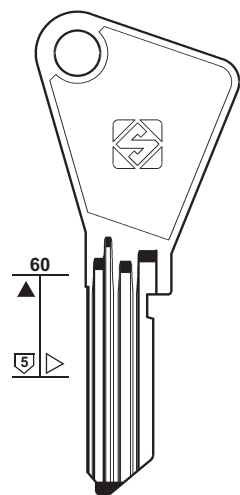

VAC101 KM235	VAC108 K200	VAC109 L202	VAC110 L226	VAC111 L229	VAC112 L230	VAC113 L240
VAC114 KL229	VAC115 K247	VAC116 KM236	VAC117 M258	VAC118 L225	VAC119 L243	VAC120 K023
VAC121 K024	VAC122 K025	VAC123 K234	VAC124 K235	VAC125 K236	VAC126 K237	VAC127 K238
VAC128 K239	VAC129 K240	VAC130 K242	VAC131 K243	VAC132 K244	VAC133 K245	VAC134 P294
VAC135 L019	VAC136 L020	VAC137 L021	VAC138 L022	VAC139 L223	VAC140 L224	VAC141 L227
VAC142 L228	VAC143 L239	VAC144 L244	VAC145 L245	VAC146 L246	VAC147 K020	VAC148 K021



184

PER / FOR

VACHETTE (F)

- AZMA
- CAP
- LAPERCHE
- + ISEO (98)
- + KWIKSET (108)
- + TITAN (168)
- + TOK-WINKHAUS (170)
- + VEGA (185)

VADETO (D)

- BLASER (32)

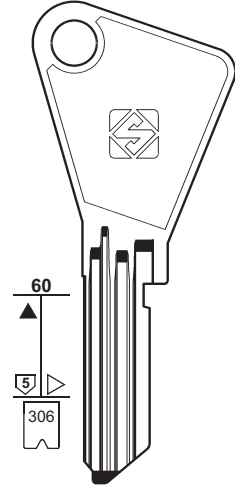

PER:
FOR:

VACHETTE

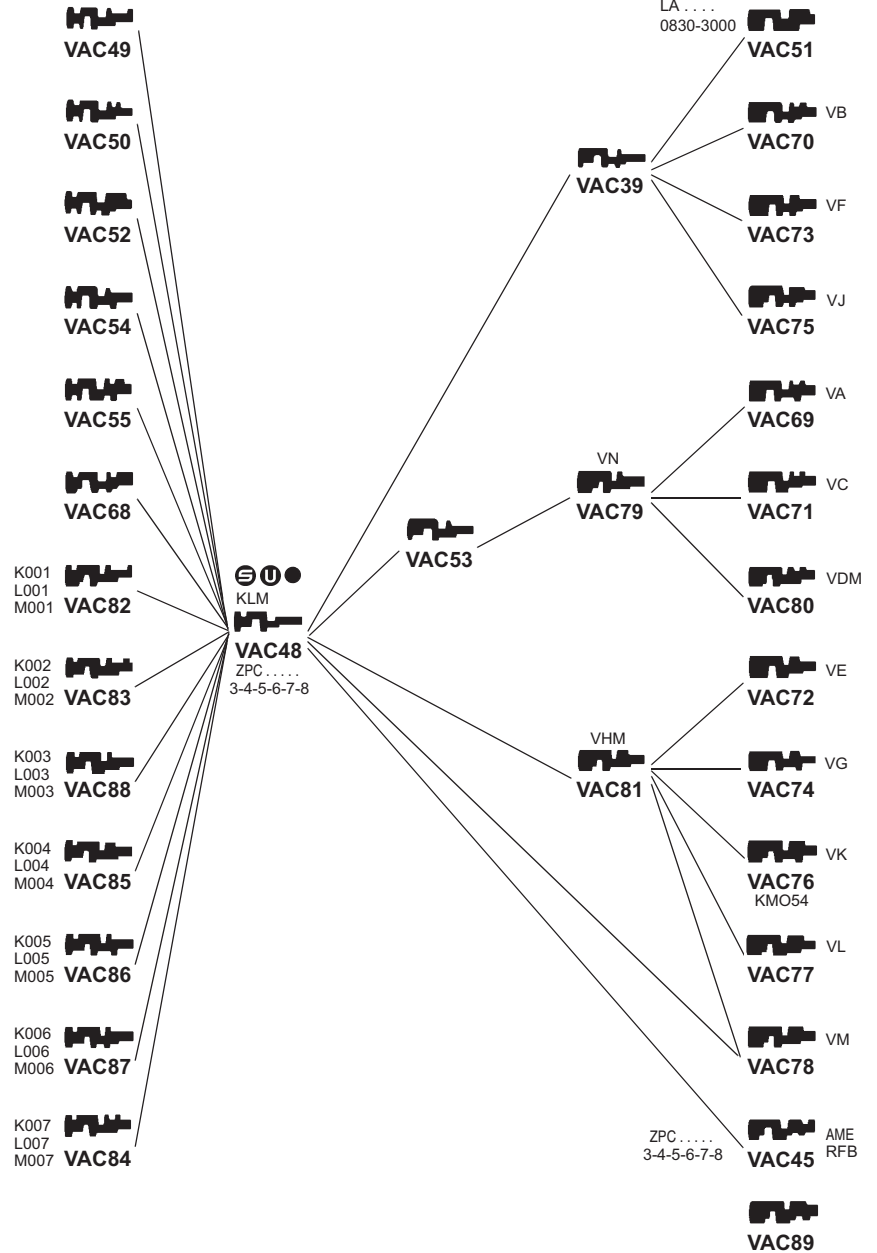

AZMA - CAP

PER:
FOR:

VACHETTE

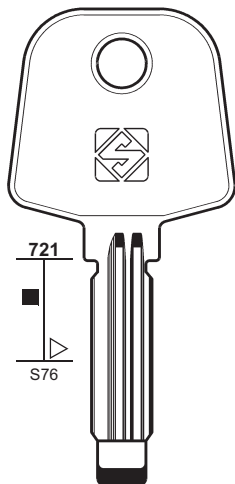

VAC91 VAC103

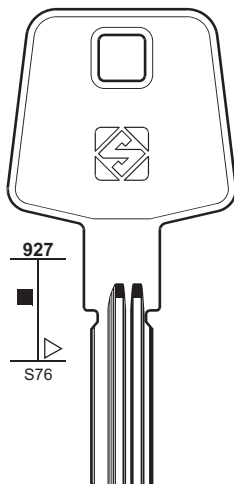

VAC104 VAC105

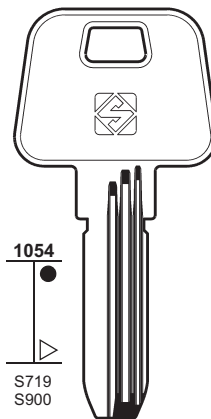

VAC150 V6

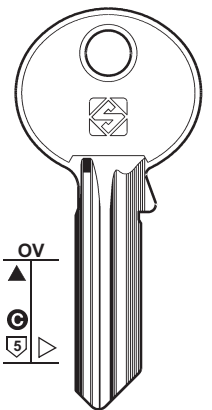

VAC151

LAPERCHE

PER: FOR:	VALE	VANGUARD	VARIOS
	Y ▲	40 ▲ ●	1569 ●
			1300 ▲ 6
	VAL1	VGD1	VAR1 VAR1R

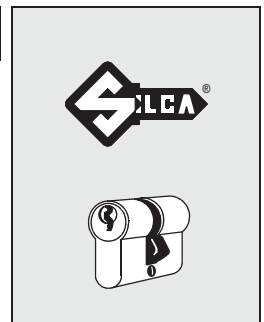

185

PER / FOR
VALE (RC)
VANGUARD (RA)
VARIO (D) 👁️ DOM (62)
VARIOS (E)
VASAR (RUS)
VAUGHN (GB) 👁️ HTV (93)
VBH (D) + 👁️ FCV (78) + 👁️ WILKA (191)
VDO (D) 👁️ KIENZLE (106)
VECO (E)
VEGA (F) VACHETTE + 👁️ ANTAR (17) + 👁️ RONIS (146)
VELO (RC) 👁️ YETI (198-199)
VENLOCK (YV) 👁️ WILSON BOHANNON (192)
VERA (CO) + 👁️ SATURN (151)
VERSCO (D) 👁️ CORBIN (53)

PER: FOR:	VARIOS	VASAR
	1300 ▲	423 ▲ ●
	1300 ▲	454 ▲
	11 ▲	5 ▲
	VAR5	VSR1R VSR2 ● VSR2R
	VAR2 VAR2R VAR3 VAR3R VAR4 VAR4R	

PER: FOR:	VBH	VECO	VEGA	VERA
	1590 ●	1 ▲	54 ▲	38 ●
	VBH1R	VC1 VC1R	VEG1	VR1
			VACHETTE	



186

PER / FOR

V.G.F. VILLATORE (I)

+ P.C. CORTELLEZZI (140)

VIDMAR (CH)

+ SEA (152)

VIKI (D)

+ DOM (62)

VINCO (D)

KARDEX
+ VACHETTE (181)

VING (N)

NOBO

VIOMETAL (F)

+ EURO LOCKS (71)

VIP (F)

+ CITY (51)

VIRO (I)

FEB

KÖNIG

+ ABLOY (4)

+ ELCA (68)

+ FAI (76)

+ TESA (166)

PER:
FOR:

V.G.F. VILLATORE

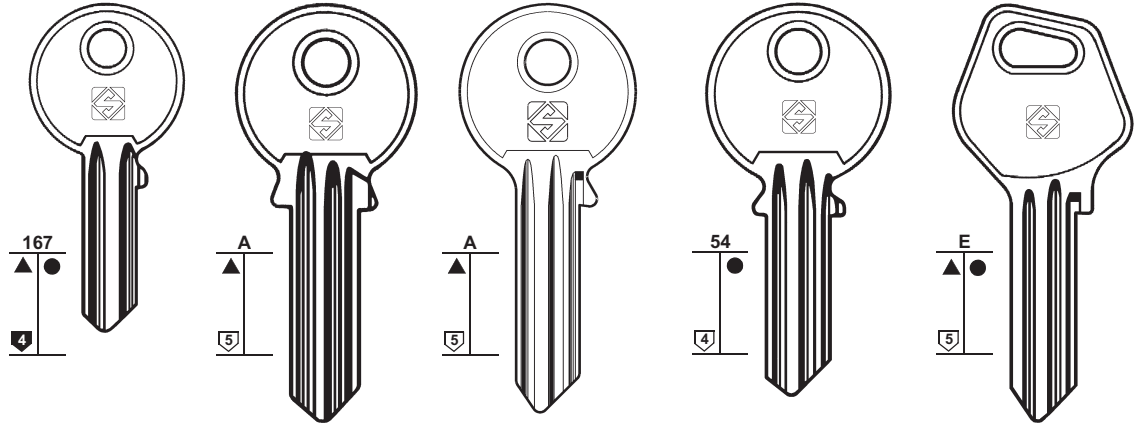

PER:
FOR:

VINCO

VING

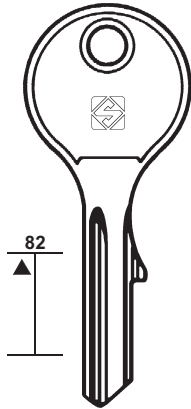

KARDEX

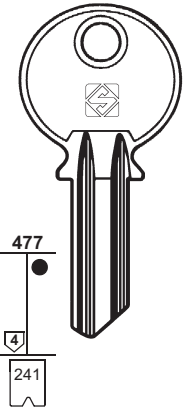
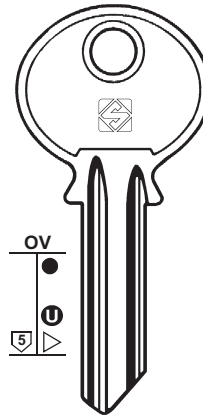
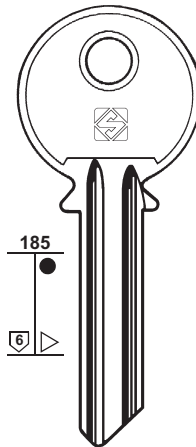

L... 5401-5650

NOBO

PER:
FOR:

VIRO

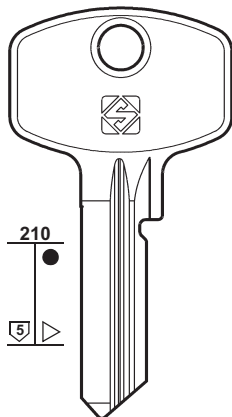

VI15R

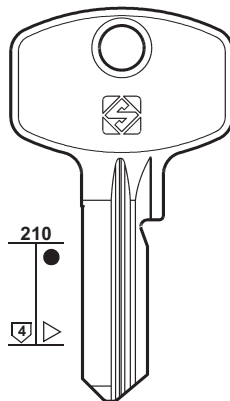

VI16R

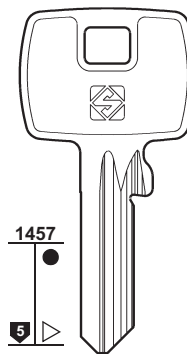

VI18R

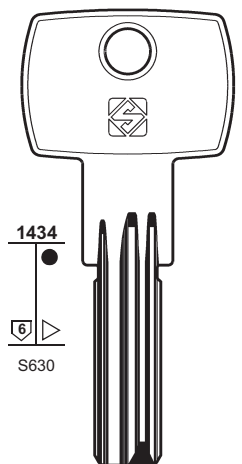

VI19
EURO-PRO

KÖNIG



FEB

PER:
FOR:

VIRO

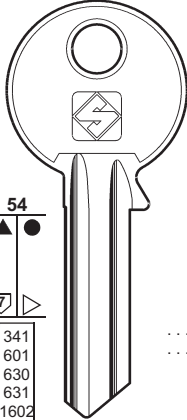

54
▲ ●
5 7
341
601
630
631
1602

VI8
VI8R
K
VI3
..... 012345
..... 6543210
VI3R
..... 012345
..... 6543210
..... 012345
..... 01234567
..... 012345
VI5
..... 012345
..... 01234567
VI5R
TS

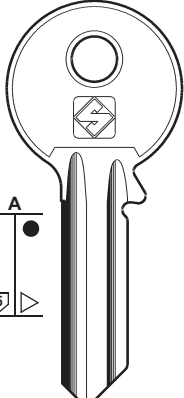

A
●
5

VI1
SPECIAL
VI1R
VI6
VI12
VI13
VI23

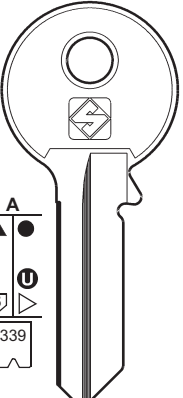

A
▲ ●
5
339

VI080
VI081
0-1-2-3-4-5-6
VI13
VI23

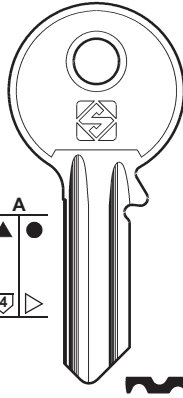

A
▲ ●
4

VI11
ABT
VI9
VI9R



187

PER / FOR

- VIRO (I)**
 ABT
 ABUS
 BERAM
 BURG
 FAI
 ROYAL
 WEISSENFELS
 + ABLOY (4)
 + ELCA (68)
 + FAI (76)
 + TESA (166)

PER:
FOR:

VIRO

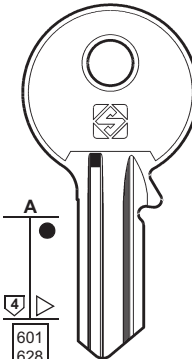

A
●
4

601
628
629

VI2
VI2R
0-1-2-3-4-5-6

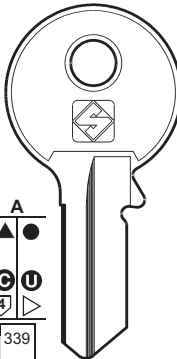

A
▲ ●
C U
4

339

VI10
VI10R
..... 0-1-2-3-4-5-6
..... 0-1-2-3-4-5
ABT

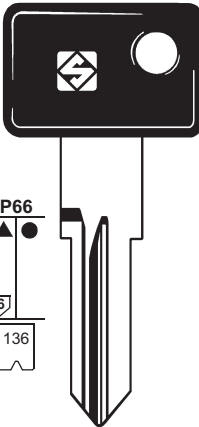

P66
▲ ●
6
136

..... 2001-3554
..... 8001-9554
ZD10P

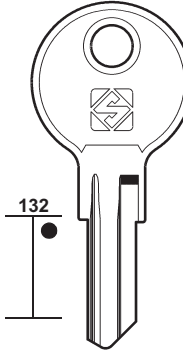

132
●

VI14
FAI

VI10
..... 0-1-2-3-4-5-6
..... 0-1-2-3-4-5
ABT

VI082
VI083 ▲ ●
0-1-2-3-4-5-6
ABT

ZD10P

PER:
FOR:

VIRO

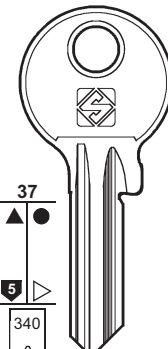

37
▲ ●
5
340

VI7
VI7R
..... 0-1-2-3-4-5

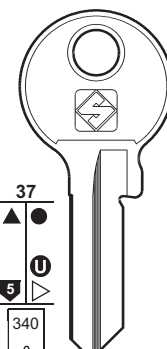

37
▲ ●
5
340

VI086
VI087
..... 0-1-2-3-4-5

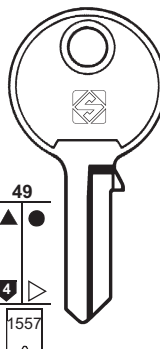

49
▲ ●
4
1557

..... 1-2-3-4-5
VI4
VI4R

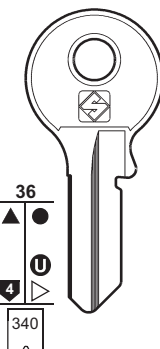

36
▲ ●
4
340

VI17
VI084
VI085 ▲ ●
..... 0-1-2-3-4-5

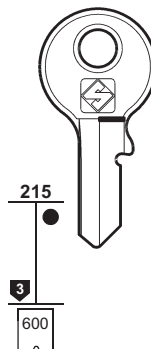

215
●
3
600

..... 1-2-3
VI088
VI089

VI7
VI7R
..... 0-1-2-3-4-5

VI086
VI087
..... 0-1-2-3-4-5

VI4
VI4R

VI17
VI084
VI085 ▲ ●
..... 0-1-2-3-4-5

VI088
VI089



BERAM - ROYAL
WEISSENFELS



BERAM - ROYAL



ABUS - ROYAL



ABUS - BURG
mm 20



188

PER / FOR

VIS (I)

VISO (RC)

- 👁️ FORT (81)
- 👁️ YETI (198-199)

VISONIC (RC)

- 👁️ ALPHA (15)

VJATKA (RUS)

VÖGEL (CH)

- 👁️ BAAL (25)

VOKO (D)

- 👁️ CES (42)
- 👁️ DOM (62)
- 👁️ JOWIL (100)

VOLGOGRAD (RUS)

VOLKOVYSK (RUS)

VOUGA (BR)

VS (D)

- 👁️ JUNIE (101)

WALE (RC)

- 👁️ YALE (195)

WALLY (I)

AKKA
MOREAUX

WANGGUAN (RC)







WANJIN (PRC)

HOOPLY

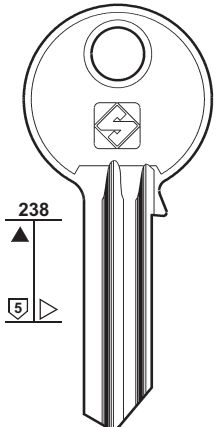
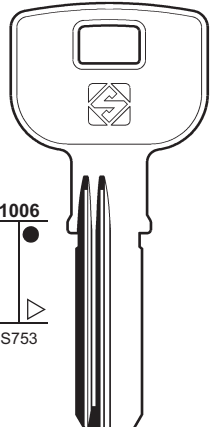
PER: FOR:	VIS	VJATKA	VOLGOGRAD	VOLKOVYSK	
	31 ▲● 5	1101 ▲	1081 ▲ ▷	1081 ▲● 5	1081 ▲● ▷
	 VS090V	 VK1 VK2	 VLG1	 VLK1R VLK2R	

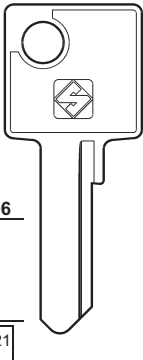
PER: FOR:	VOUGA	WALLY			
	1533 ▲●	A ▲● 9	A ▲● 6	A ▲● C U 5 620	A ▲● C U 4 620
	 VOG1	 KK1	 WA6 WA6R	 WA1▲● WA1R⊖	 WA2▲● WA2R
				1-2-3-4-5-6-7-8 MOREAUX	1-2-3-4-5-6-7-8

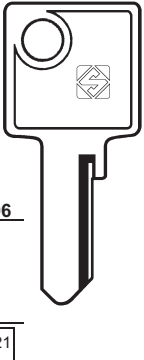
PER: FOR:	WALLY			WANGGUAN	WANJIN
	H ▲ 3 619	11 ▲ 5	11 ▲● 4	401 ▲●	1603 ▲● 7
	 WA7 WA7R	 WA3 WA3R	 WA4 WA4R	 WGU1	 WJ1R
	1-2-3-4-5-6-7-8				 HOOPLY

PER: WASA-IVANA FOR:	WAUS	WEBER	
 <p>238 5</p> <p>● WSA1 WSA2R</p>	 <p>1006 S753</p> <p>WU1R</p> 	 <p>296 6 421</p> <p>WEB1 WEB3 ... 1-594 A ... 1-594</p> <p>WEB5</p>  WECO	 <p>296 5 421</p> <p>WEB2 WEB4 ... 1-594 A ... 1-594</p>  WECO

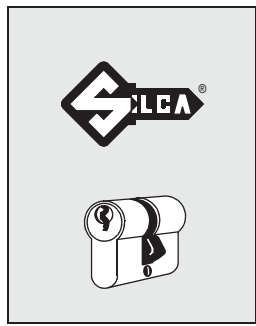

189

PER / FOR
WASA-IVANA (PL)
WASO (D) 👁️ CES (41-42)
WAUS (P)
WB (F) 👁️ KKL (107)
WEBER (D) WECO
WEBSTER (GB)
WECO (D) 👁️ CES (41-42) 👁️ WEBER (189) 👁️ YALE (194)
WEISER (USA) (GB) (B) FALCON FICHET IDEAL-SECURITY KAWE + 👁️ FALCON (76)
WEISSENFELS (D) 👁️ VIRO (187)
WELKA (I) + 👁️ YALE (193)

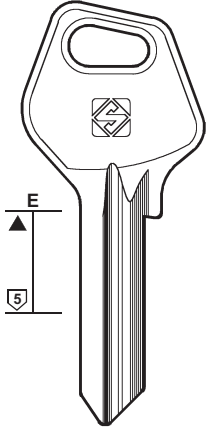
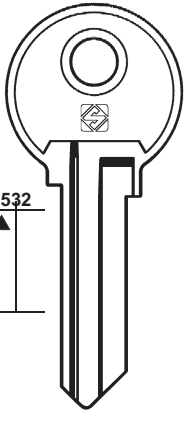
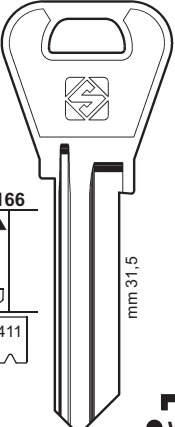
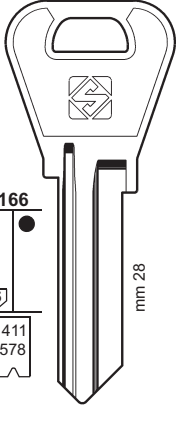
PER: WEBSTER FOR:	WEISER		
 <p>E 5</p> <p>WTR1R</p>	 <p>532</p> <p>WEI3</p>	 <p>166 6 411 mm 31,5</p> <p>● WEI9 0-1-2-3-4-5-6-7-8-9 E 0-1-2-3-4-5-6-7-8-9</p> <p>WEI2 0-1-2-3-4-5-6-7-8-9 E 0-1-2-3-4-5-6-7-8-9</p> <p>FICHET</p>	 <p>166 5 411 578 mm 28</p> <p>▲ WEI8 E 0-1-2-3-4-5-6-7-8-9 E 0-1-2-3-4-5-6-7-8-9</p> <p>WEI1 E 0-1-2-3-4-5-6-7-8-9 E 1-2-3-4-5-6-7-8-9 0-1-2-3-4-5-6-7-8-9</p> <p>KAWE</p>

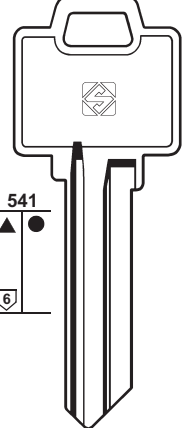
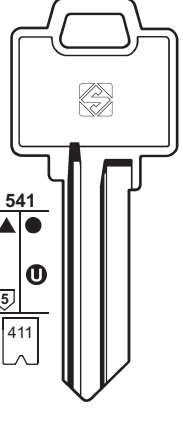
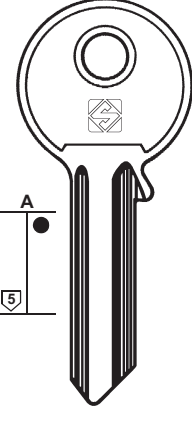
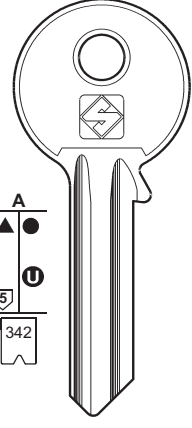
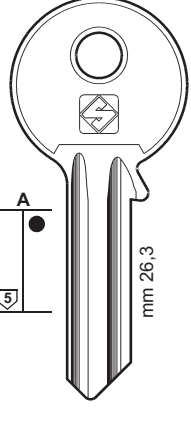
PER: WEISER FOR:	WELKA			
 <p>541 6</p> <p>WEI4</p> <p>FALCON</p>	 <p>541 5 411</p> <p>WEI5 E 0-1-2-3-4-5-6-7-8-9 0-1-2-3-4-5-6-7-8-9</p> <p>IDEAL SECURITY</p>	 <p>A 5</p> <p>WE5 WE5R</p>	 <p>A 5 342</p> <p>⊖ WE1 WE1R 12345 012345</p> <p>● WE16 ● WE16R</p>	 <p>A 5 mm 26,3</p> <p>WE7 WE7R</p> <p>WE14</p>



190

PER / FOR

WELKA (I)

+ **YALE** (193)

WEPA (D)

JOWIL (100)

WESCO (D)

KIFERM (106)

LAS (110)

WESLOCK (USA)

WEST (J)

WFE (D)

WHALE (i)

GLOBE (87)

PER:
FOR:

WELKA

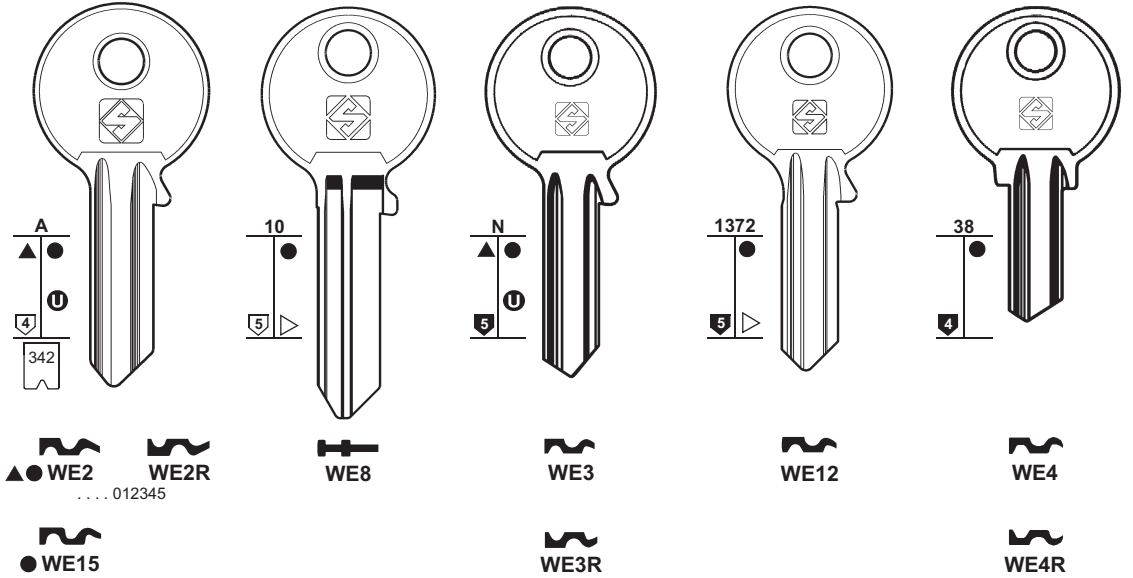

PER:
FOR:

WESLOCK

WEST

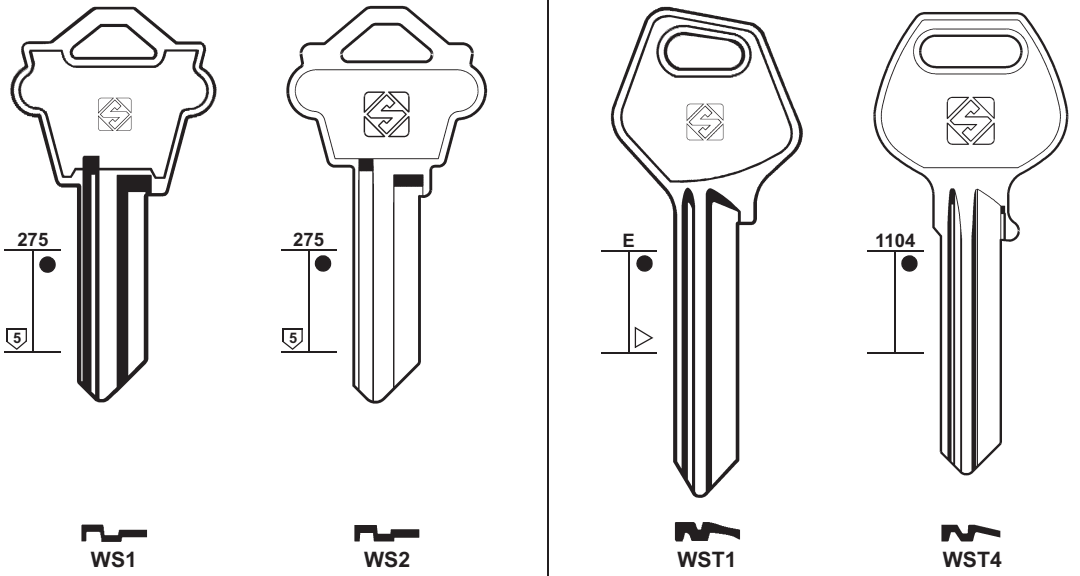

PER:
FOR:

WEST

WFE

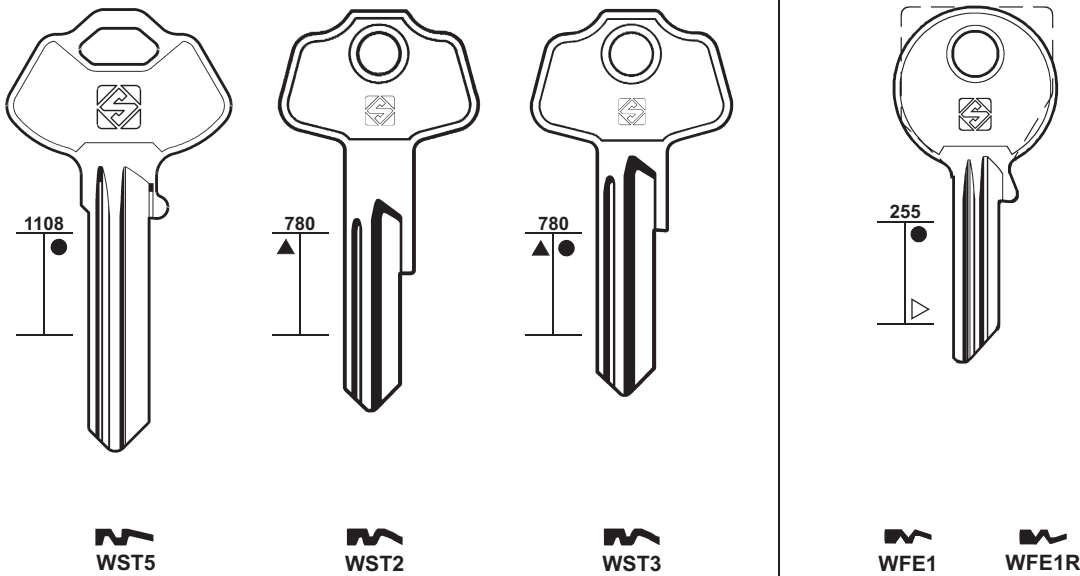

PER:
FOR:

WHITCO

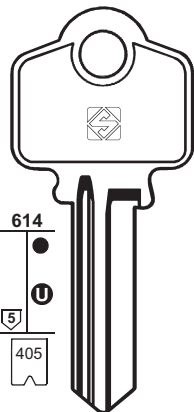

..... 0123456789A



WC1

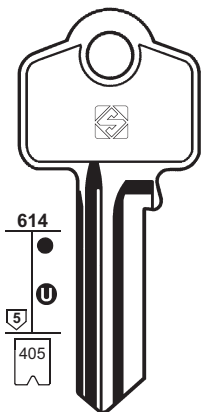

..... 0123456789A



WC2

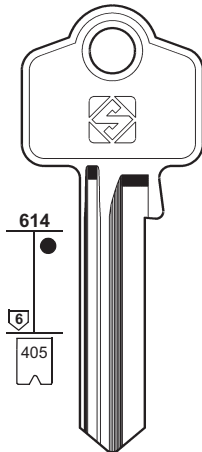

..... 0123456789A



WC3



191

PER / FOR

WHITCO (AUS)

WIGRO (D)

WILKA (191)

WILKA (D)

CFP

DIERRE

DORMA

EMKA

GBS

JORE

TOP

VBH

WIGRO

+ BLASER (32)

PER:
FOR:

WILKA

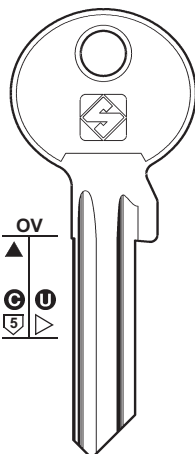

WK1X

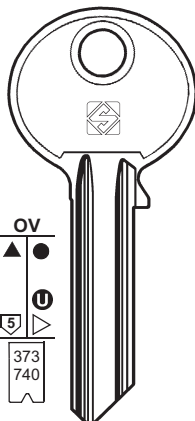

..... 123456789
..... 400001-430000



WK1

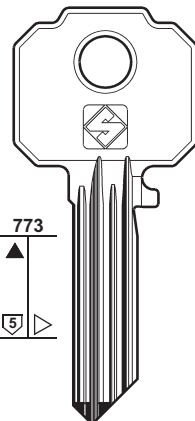

WK59R WK49R

WK60R WK50R

WK63R WK51R

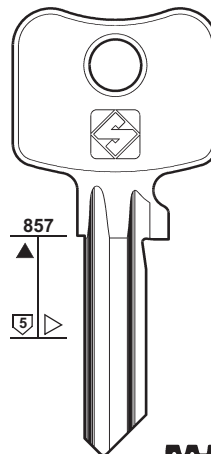

WK69

WK55 WK68R

JORE - TOP - WIGRO

EMKA - DIERRE - DORMA - VBH

PER:
FOR:

WILKA

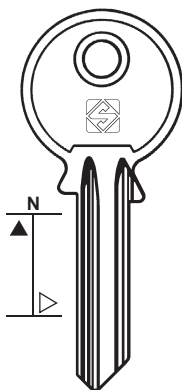

WK3

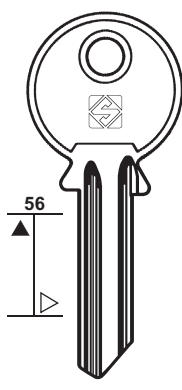

WK8



WK8R

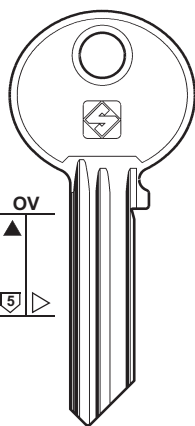

WK7 WK26 WK31 WK36 WK18

WK16 WK27 WK32 WK37 WK19

WK46 WK28 WK33 WK38 WK20

WK48 WK29 WK34 WK39 WK21

WK30 WK35 WK40 WK22



WK5

CFP - GBS



192

PER / FOR

WILKA (D)
+ **BLASER (32)**

WILLACH (D)
 HUWIL (94)

WILLENHALL (GB)
 GIBBONS (86)

WILSON BOHANNON (USA)
VENLOCK

WINFIELD (RC)
 YETI (198-199)

WINFOR (GB)
 MERONI (124)

WINKHAUS (D)
 TOK-WINKHAUS

WINLOCK (GB)

WINNER (F)
 GABON (84)

WIREROPE (HK)

W.M.S. (GB)
I.R.
TITUS
+ **AVOCET (24)**

WOC (F)
 YALE (193)

PER:
FOR:

WILKA

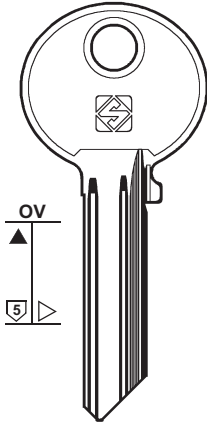

- | | | | | |
|-------|-------|-------|-------|-------|
| WK6 | WK4 | WK9 | WK2 | WK2R |
| WK6R | WK41R | WK42R | WK10 | WK17R |
| WK25 | WK15 | WK14 | WK45R | WK47R |
| WK25R | WK43R | WK13 | WK52R | WK56R |
| WK44R | WK53R | WK12 | | |
| | WK54R | WK11 | | |

PER:
FOR:

WILKA

WILSON BOHANNON

WINLOCK

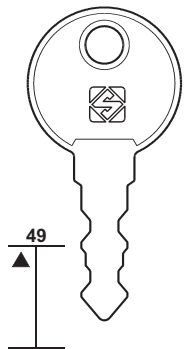
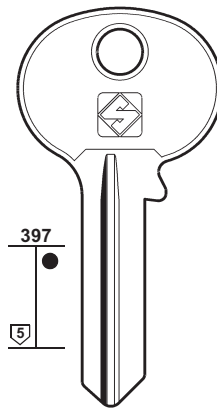
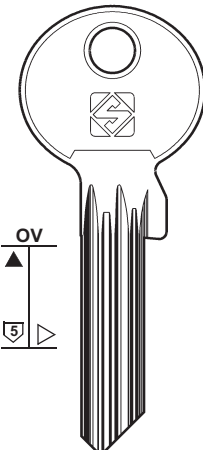
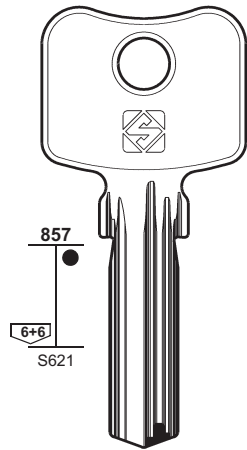

WK70
.....
10001-43000



WK45X



WK71X



WH1

VENLOCK



WLC1



PER:
FOR:

WIREROPE

W.M.S.

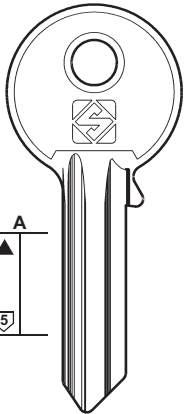
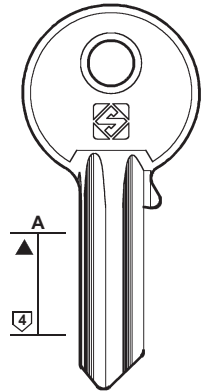
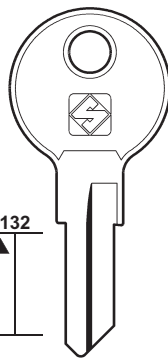
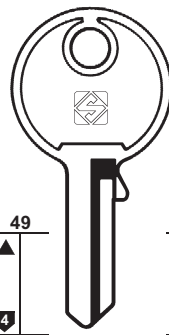
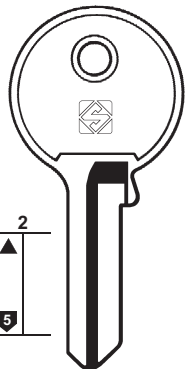
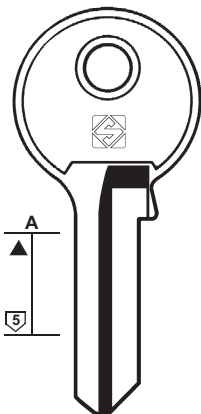

WR1



WR2



WR3



WR4



WR5R



WMS1



WMS2

I.R. - TITUS

PER: FOR:	WS	XIEHE	YALE	
	OV ▲ 5	49 ● 4	OV ▲ 6	OV ● 5
	 WSD1	 IEH1	 YA27R	 YA9
			D GB	D GB

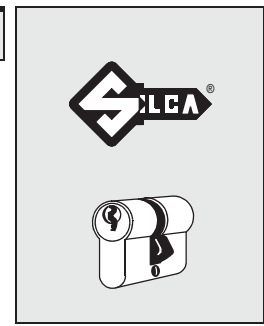

193

- PER / FOR**
- WS (D)**
 - WÜRTH (D)**
 - CORBIN (53)
 - HUWIL (94)
 - XIEHE (PRC)**
 - YAC (F)**
 - RONIS (147)
 - YALE (D) (GB) (USA)**
 - BIRD
 - BKS
 - CARAT
 - CKS
 - KALE
 - LAREDO
 - PRIVE
 - ROC
 - UMF
 - WELKA
 - WOC
 - + ● BKS (30-31)
 - + ● HTV (93)
 - + ● URBIS (180)

**PER:
FOR:** **YALE**

185 ▲ ● 6	182 ▲ ● 5	182 ▲ ● 5	182 ▲ ● 5	182 ▲ ● 4
D GB	D	GB	USA	D GB
 YA5	 YA1	 YA1E	 YA36	 YA29
 YA5R	 YA1R	 YA1ER		 YA29R
	BIRD - BKS - CARAT CKS - KALE - LAREDO ROC - WELKA - WOC		PRIVE	UMF

**PER:
FOR:** **YALE**

OV ▲ 6	185 ● 6	OV ● 6	551 ▲ ● 5	551 ▲ ● 6
			412	412
 YA84	 YA86	 YA67	 YA35	 YA64
 YA84R	 YA86R			 YA64R
	 YA85R			
		USA	USA	USA

A 0123456789
 0123456789
 0123456789
 0123456789
 A 0123456789
 0123456789
 0123456789



194

PER / FOR

YALE (D) (GB) (USA)

- ABUS
- BENDIX
- BKS
- CAB
- CHICAGO
- COLE-HERSEE
- HUDSON
- SOUTHCO
- SUREX
- WECO

- + BKS (30-31)
- + HTV (93)
- + URBIS (180)

PER:
FOR:

YALE

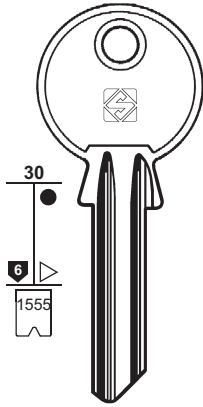

RP ... 1001-3400

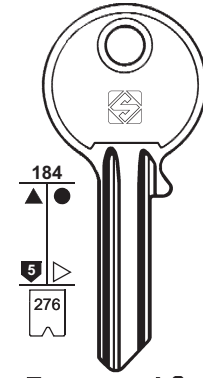

● YA30
ABS ...
7537-8336

▲ YA30R

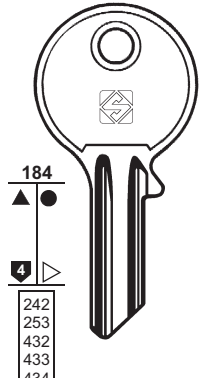

YA8
FB ... 101-1100
FP ... 101-1100
R ... 101-160
MC ... 101-850

YA8

YA8R
SUREX



YA8E ▲

- BM...1-1000
- KA...1-1000
- KB...1-1024
- AT...1-1040
- A...1-1100
- DB...1-1100
- ...1-1600
- B...1-1600
- BS...1-1600
- D...1-1600
- E...1-1600
- F...1-1600
- IC...1-1600
- JA...1-1600
- JD...1-1600
- JB...1-1600
- JV...1-20025
- KD...1-4950
- ABS...1-6000
- D...1-750
- R...10-101
- KA...1001-2000
- FB...101-1100
- FP...101-1100
- R...101-160
- KV...100026-120025
- BT...1451-2250
- KV...20026-40025
- CM...250-1349
- DC...251-1350
- FS...297-1396
- KV...120026-140025
- KV...40026-60025
- FD...501-1600
- KV...60026-80025
- KV...80026-100025

YA21 ●
TBS ... (AB) 401-450
SC ... (AB) 101-150

YA22 ●
SC ... 1-50
TBS ... (AC) 451-500

YA23 ▲
SC ... (AD) 51-100
TBS ... (AD) 501-500

YA15 ▲
SX ... 1-1000
VR ... 1-4000
BX ... 1-500
VW ... 1-4000

YA8ER ▲



YA24 ●
TBS ... (BC) 551-600

YA25 ●
SC ... (BC) 201-250
TBS ... (BD) 601-650

YA26 ●
SC ... (CD) 151-200
TBS ... (CD) 651-700

YA15R ●



BKS - WECO

PER:
FOR:

YALE

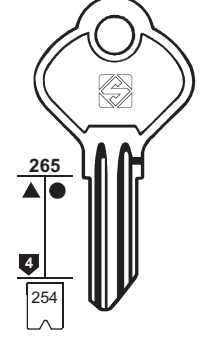

▲ YA20 ▲ YA20R

YA17 YA17R
DC ... 551-952
TOK ... 1-99
RS ... T 1-99

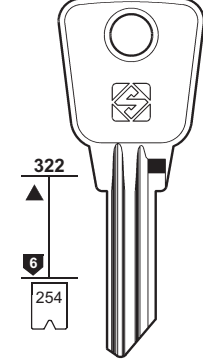

YA19 YA19R ●
LT ... 1-100
LC ... 1-100

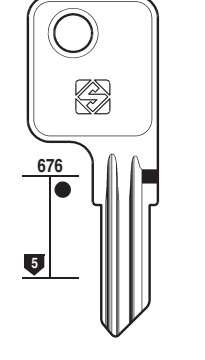
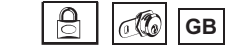
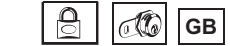
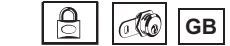
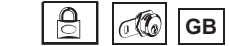

YA65 YA65R

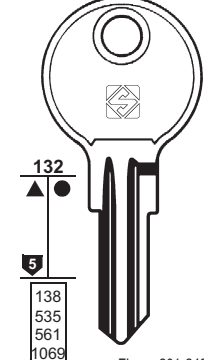

FL ... 201-240
LL ... 226-450
UM ... 226-450
... 500-550
... 600-650

YA18 SOUTHCO YA18R

YA4 YA4R
HC ... 001-202
KC ... 251-500

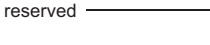
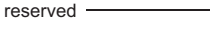
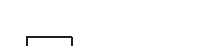
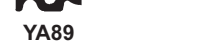
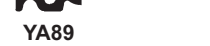
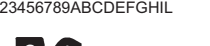
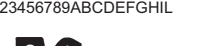
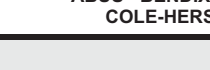
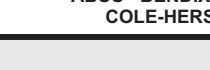
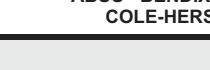
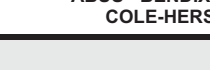

ABUS - BENDIX - CAB - CHICAGO
COLE-HERSEE - HUDSON

PER:
FOR:

YALE

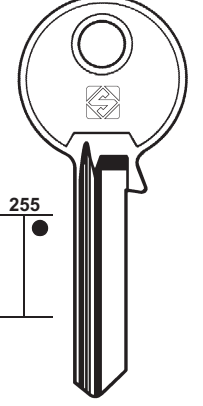

YA16L YA16RL

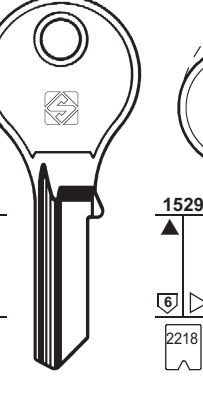

YA16 YA16R

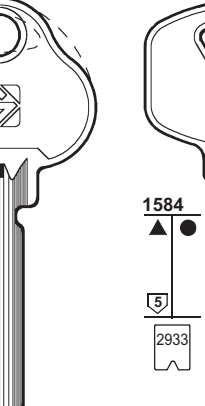

YA88 X5

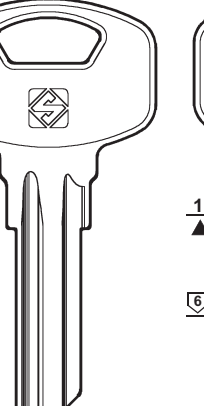

YA89



YA91



PER:
FOR:

YALE

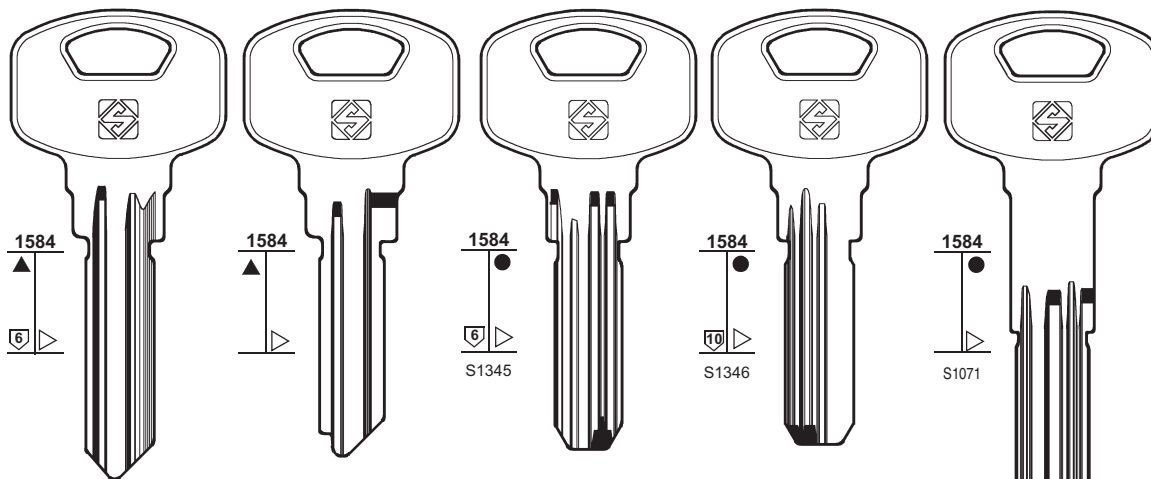

YA93

YA87
KTM

YA94
"1000 Series"

YA95R
"2000 Series"

YA90



195

PER / FOR

YALE (I)
FERCO
SOS
WALE

PER:
FOR:

YALE (I)

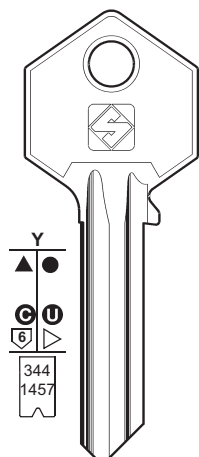

..... 0-1-2-3-4-5-6-7-8-9
..... 0-1-2-3-4-5-6-7-8

YA31 YA31R

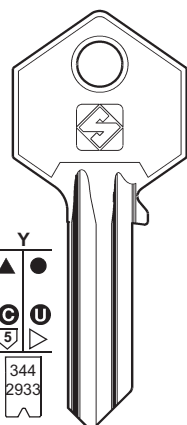

YA63

YA226 YA227 0123456789
..... 0-1-2-3-4-5-6-7-8-9

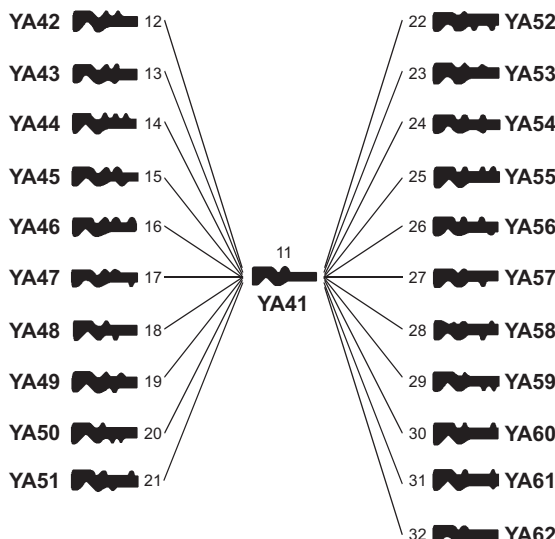

FERCO - WALE

PER:
FOR:

YALE (I)

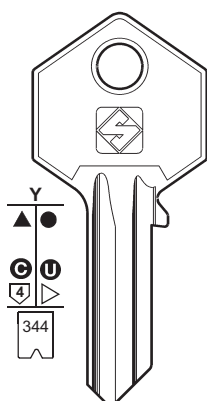

..... 0-1-2-3-4-5-6-7-8-9

YA6R
YA6

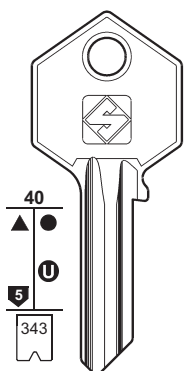

..... 1-2-3-4-5-6-7-8

YA7
YA7R

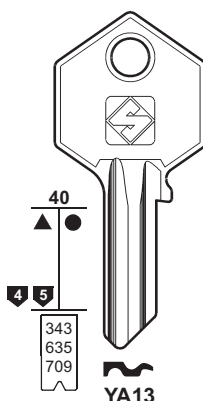

..... 1-2-3-4-5-6-7-8
..... 1-2-3-4
..... 0-1-2-3-4-5

YA13R

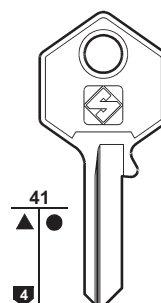

YA14

YA14R

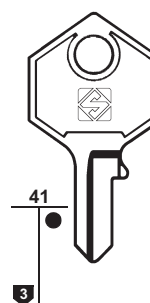

YA33





196

PER / FOR

YALE (I) (D) (GB) (USA)

+ BKS (30-31)

+ HTV (93)

+ URBIS (180)

PER:
FOR:

YALE (I)

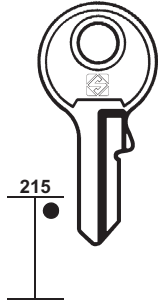

YA74



YA74R



MIGNON



CS28



CS28R



MIGNON

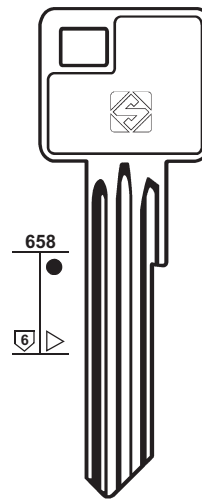

YA39

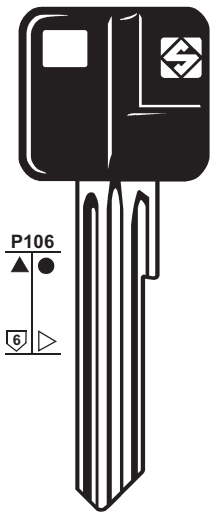

YA39P

PER:
FOR:

YALE (I)

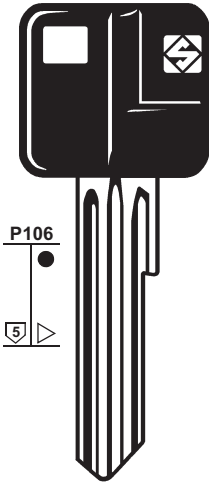

YA40P

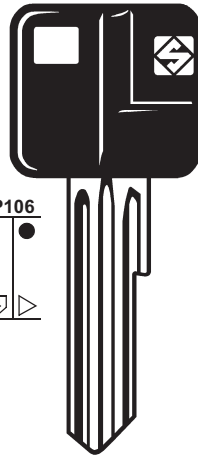

YA73P

YALE (USA)

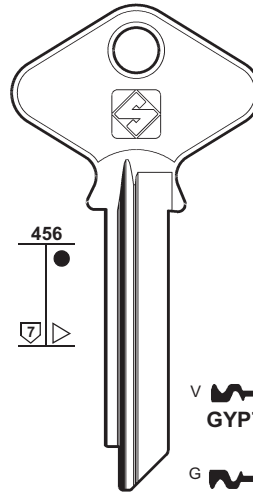

V GYP7R

G GYP7

GA GYA7

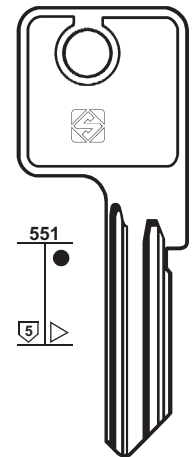

G GYP8

V GYP8R

PER:
FOR:

YALE

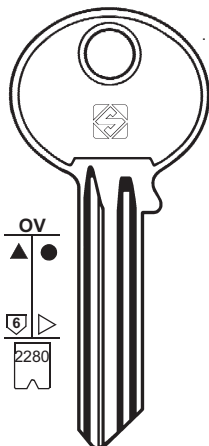

D GB

GA GYA6
..... 0-1-2-3-4-5-6

GC GYC6

GG GYG6

GB GYB6

GE GYE6

GH GYH6

GD GYD6

GF GYF6

GK GYK6

G GYP6B
YA2

V YA2R

VYP6A VA VYA6

VC VYC6

VG VYG6

VB VYB6

VE VYE6

VH VYH6

VD VYD6

VF VYF6

VK VYK6

PER:
FOR:

YALE

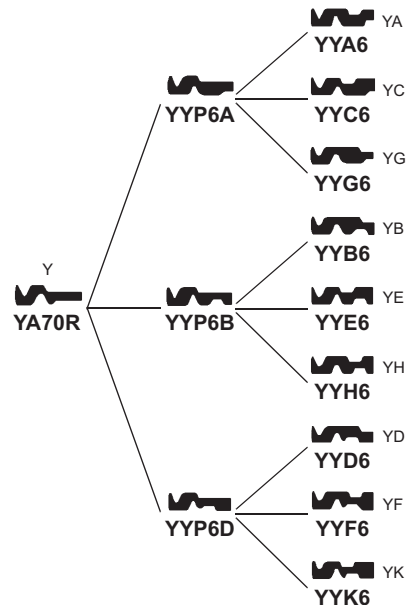
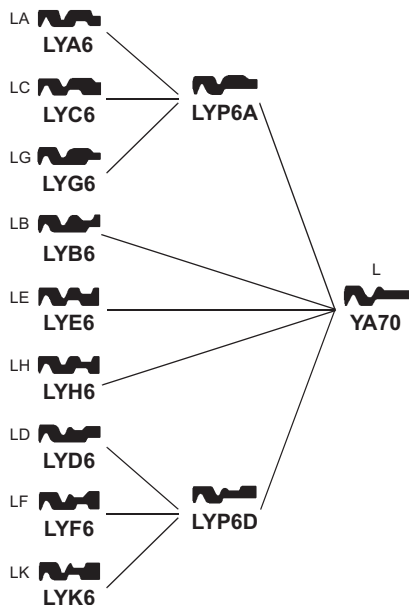
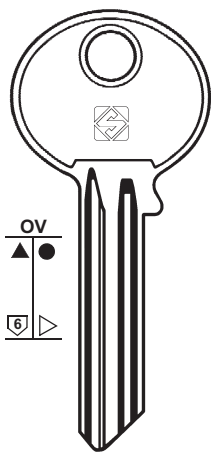

197

PER / FOR

YALE (D) (GB)
 + BKS (30-31)
 + HTV (93)
 + URBIS (180)

YALTRES (RA)
 FTH (82)

YANEDIS (GB)
 ETAS (70)

PER:
FOR:

YALE

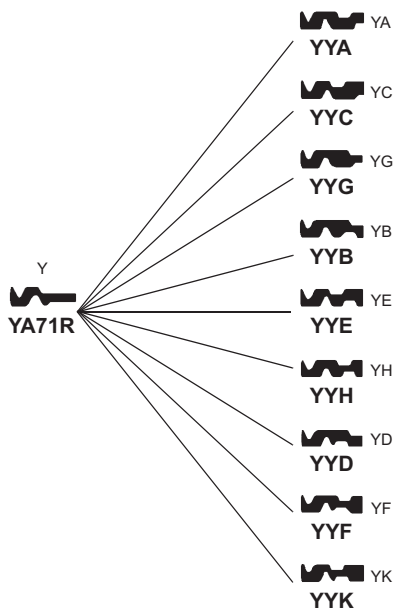
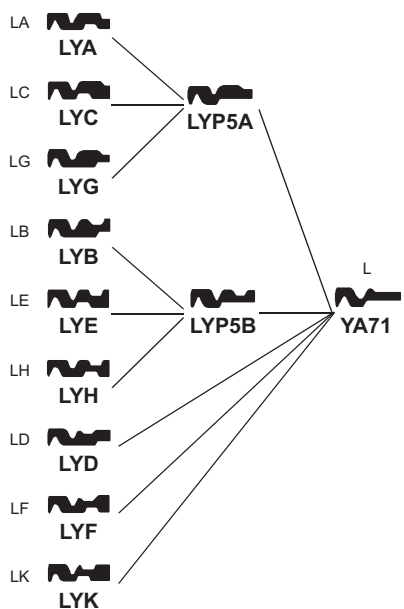
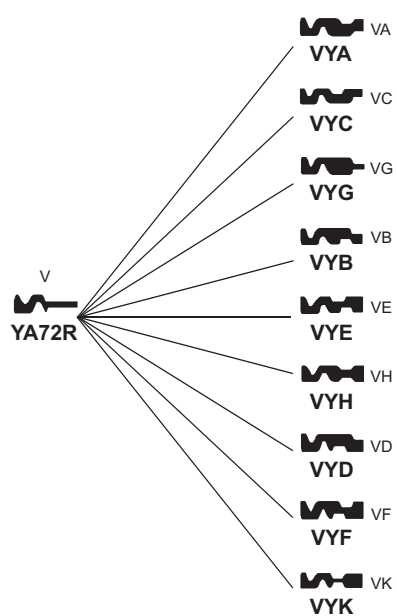
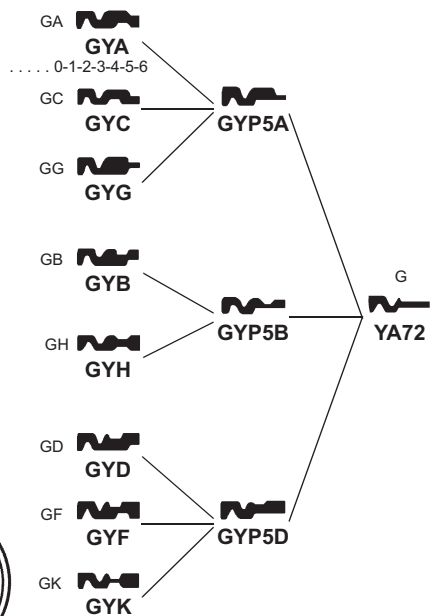
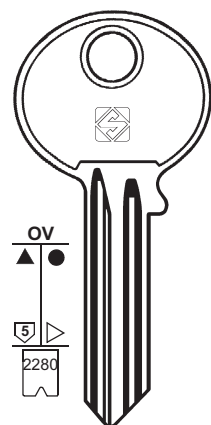



198

PER / FOR

YANMAR (J)

YARDENI (IL)

YEMAR (E)
UCEM (175)

YETI (PL)
FAB (74)
LOB (114)
MCM (121)

YETI (RC)
AKIRA
ASIA
BEDI
BELL
DEHA
FOUR-CIRCLE
HAIDE
HEAD
HEMY
HERMES
LOTUS
RAM
ROYAL
SANCHUN
SEZAN
SWAN
VELO
VISO
WINFIELD

PER: YANMAR
FOR:

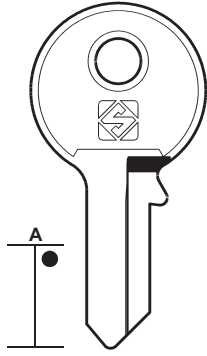

YAR1



YARDENI

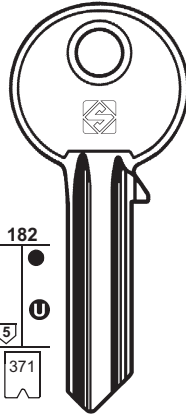

YD1 ▲YD1R

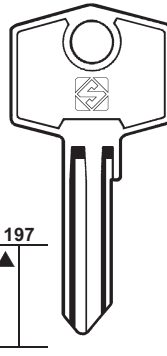

YD2 YD2R

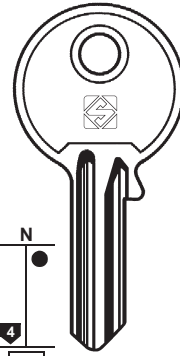

YD4 YD4R ▲

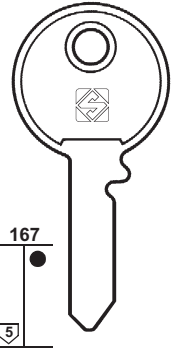

YD5R



PER: YARDENI
FOR:

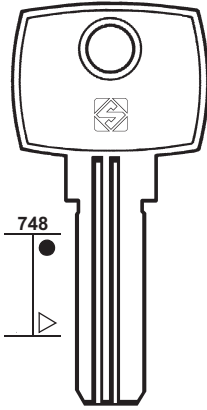

YD3R

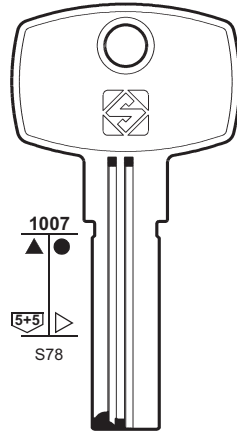

YD6R

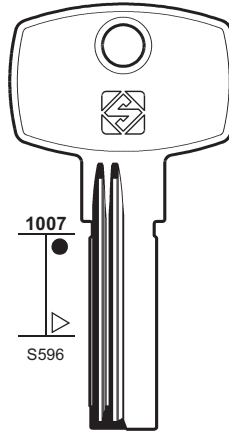

YD7R

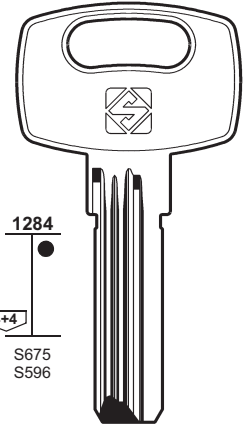

YD13R YD14R



PER: YETI
FOR:

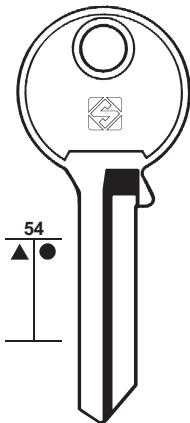

YT6 YT6R

●YT12 YT12R ▲

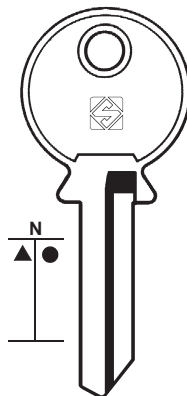

YT7 YT7R

YT13 YT13R

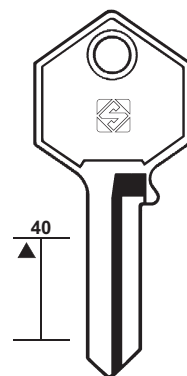

YT8 YT8R

●YT14 YT14R ●

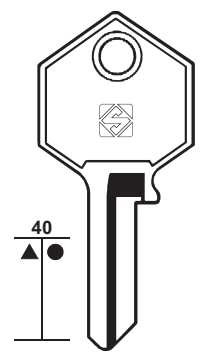













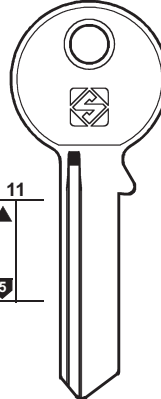
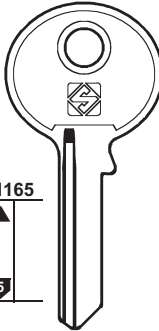







YT1 YT1R

▲YT3 YT3R ▲

AKIRA - ASIA - BEDI - BELL - DEHA
FOUR-CIRCLE - HAIDE - HEMY - HERMES
HEAD - LOTUS - RAM - ROYAL - SANCHUN
SEZAN - SWAN - VELO - VISO - WINFIELD



mm 40

YETI			YUN HUAN	
				
277	12	215	11	1165
 YT9  YT9R  YT2  ▲YT2R	 YT10  YT10R  YT4  ▲YT4R BENCO NOVA	 ●YT11  YT11R  ●YT5  YT5R ●	 YUH2R	 YUH1R
 mm 30	 mm 25	 mm 20		
AKIRA - ASIA - BEDI - BELL - DEHA - FOUR-CIRCLE HAIDE - HEMY - HERMES - HEAD - LOTUS - RAM - ROYAL SANCHUN - SEZAN - SWAN - VELO - VISO - WINFIELD				

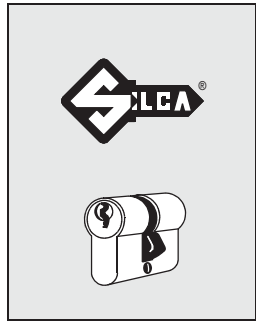

199

PER / FOR











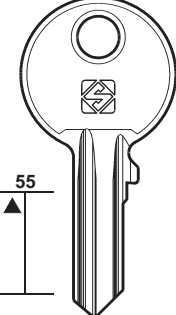
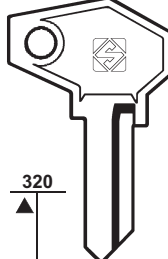
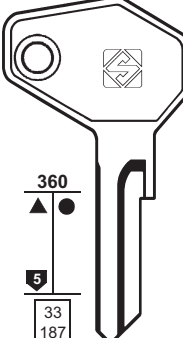
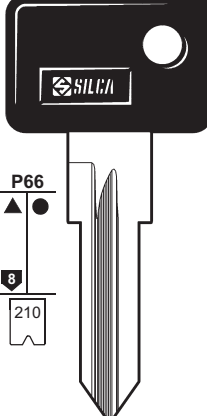

YETI (RC)
 AKIRA
 ASIA
 BEDI
 BELL
 BENCO
 DEHA
 FOUR-CIRCLE
 HAIDE
 HEAD
 HEMY
 HERMES
 LOTUS
 NOVA
 RAM
 ROYAL
 SANCHUN
 SEZAN
 SWAN
 VELO
 VISO
 WINFIELD







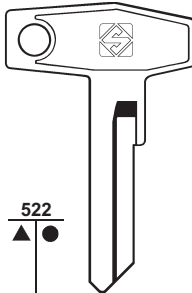
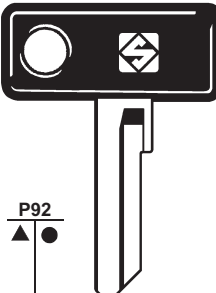
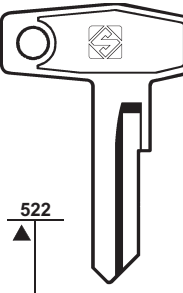
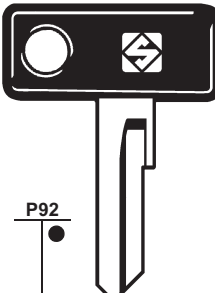

YONGTAI (RC)
 TRI-CIRCLE (173)

YUN HUAN (PRC)

YVEL (F)
 RICOUARD (146)

ZADI (I)
 + BRETER (34)

ZADI (I)			
			
55	320	360	P66
	4	5	8
	54 186	33 187 389	210
 ZD5  ZD5R  ZD4  ZD4R	 ZD8 ... 1-253  ZD6 2 ... 1-624	 ZD7 ... 1-1625 ... 9001-9500 E ... 1-500 E ... 501-710	 ZD14RP ... 5001-6475 C ... 5001-6475
			

ZADI (I)			
			
522	P92	522	P92
4 5	4 5	4	4
53 187 389	53 187 389	53 187 743 3205	53 187 743 3205
 ZD9 ... 1-1625 E ... 500 E ... 501-710 ... 9001-9500 ... 5001-6278	 ZD9P ... 1-1625 E ... 500 E ... 501-710 ... 9001-9500 ... 5001-6278	 ZD11 ... 1-1625 E ... 1-500 ... 5001-6278 E ... 501-710 ... 1234 H ... 100-341	 ZD11P ... 1-1625 E ... 1-500 ... 5001-6278 E ... 501-710 ... 1234 H ... 100-341
			



200

PER / FOR

ZADI (I)
BULLOCK
+ BRETER (34)

ZANETTI A. (I)
GHIDINI
OB
ROLEX
TAUB
TOR

ZANI (I)
BALLY
FIC
SINA
ZETA
+ ICSA (94)
+ MORI E. (129)

ZĚČĚ (HR)
CORBIN (53)

ZEISS IKON (D)
BRUMME
OTIS
+ BAB (26)
+ CORONA (55)

PER:
FOR:

ZADI

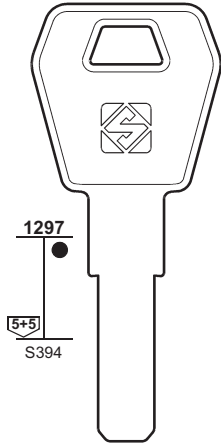

ZD25

BULLOCK

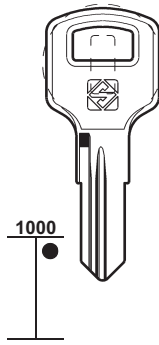

ZD26R

ZANETTI ANGELO

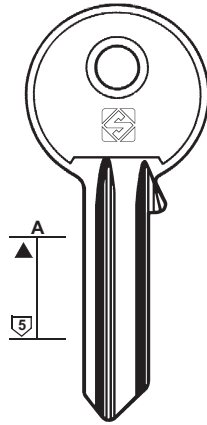

ZA2R

GHIDINI - OB - ROLEX - TAUB - TOR

PER:
FOR:

ZANI

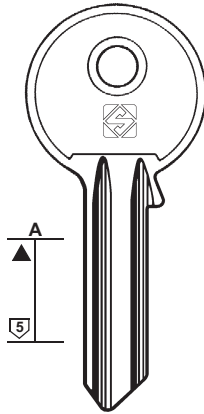

ZI1 ZI1R

ZI5 ZI5R

BALLY - FIC - SINA - ZETA

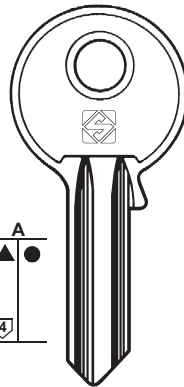

ZI2R

ZI4 ZI4R

BALLY

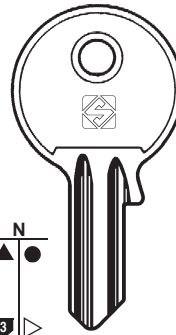

ZI3R

ZEISS IKON

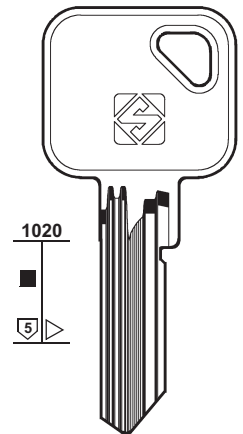

ZE45

PER:
FOR:

ZEISS IKON

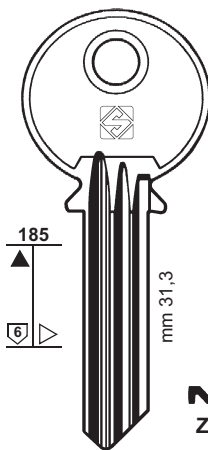

ZE42

ZE14 ZC

ZE11 ZD

ZE14R ZA

ZE11R ZB

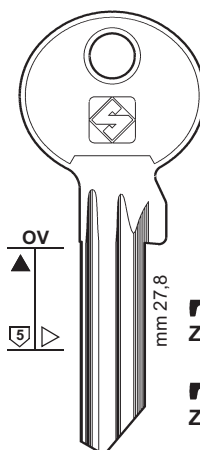

ZE34X SN1

ZE39X SN3

ZE40X SN5

BRUMME - OTIS
ZE1X N1

ZE34RX SN2

ZE39RX SN4

ZE1RX N2

BRUMME - OTIS
ZE1RX N2

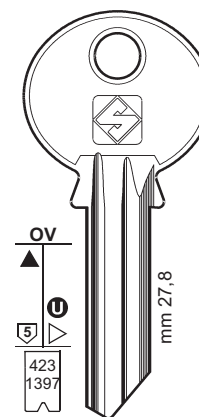

ZE15 Z 461
ZE16 Z 484

ZE13 ZC
ZE13R ZA

ZE10 ZD
ZE10R ZB

ZE34 SN1
ZE34R SN2

ZE39 SN3

ZE1 N1
ZE1R N2
..... (TK5)
1-2-3-4-5-6-7-8-9-0
A-B-C-D-E-F-G-H-I-L
..... (TK6)
1-2-3-4-5-6-7-8-9-0
A-B-C-D-E-F-G-H-I-L

BRUMME - OTIS

PER:
FOR:

ZEISS IKON

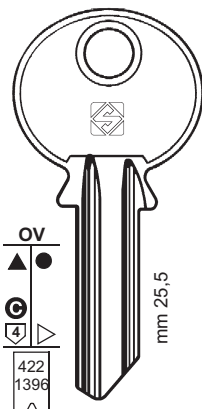

ZE2
N 11
..... (SK5)
1-2-3-4-5-6-7-8-9-0
A-B-C-D-E-F-G-H-I-L

BURG

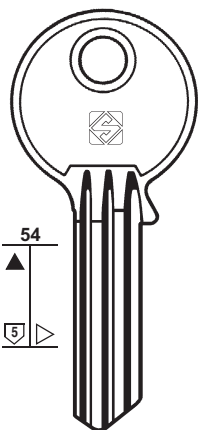

ZE12
M

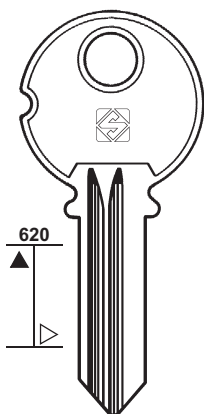

ZE30 **ZE30R**
DS2 DS1

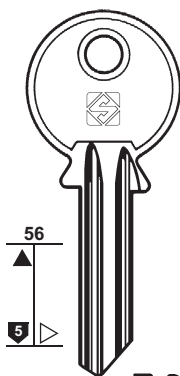

ZE5
K5

ZE5R ▲ ●
K60

ZE7



ZE4
K3



ZE3
K1

ZE3R
K2

CORONA - FORTSCHRITT



201

PER / FOR

ZEISS IKON (D)
BURG
CORONA
FORTSCHRITT
+ 👁️ BAB (26)
+ 👁️ CORONA (55)

ZENI (GB)

ZENICA (F)

ZENITH (F) (I)
ARNOV
AUBERT
FO
MONOBLOC
QCP
SIAM
SICMA
+ 👁️ CITY (51)
+ 👁️ SIS (155)

ZETA (I)

👁️ ZANI (200)

PER:
FOR:

ZENI

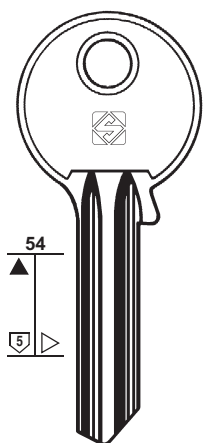

ZN1

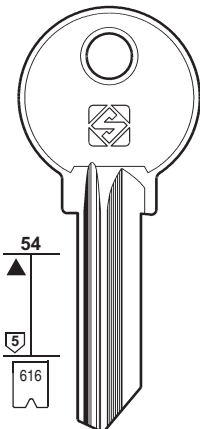

CA14

CA8 ▲ ●
170000-176310
..... 0123456

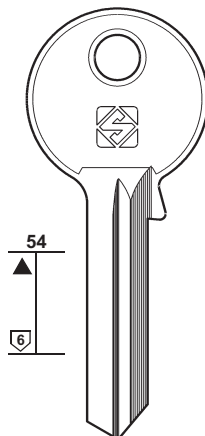

CA13

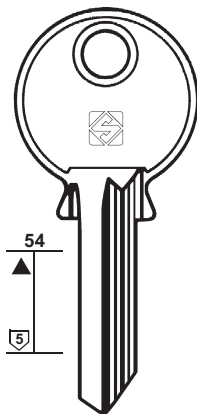

CA12

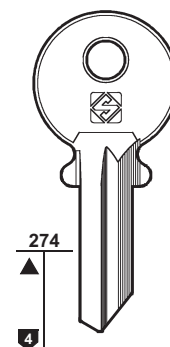

CA6

PER:
FOR:

ZENITH (F)

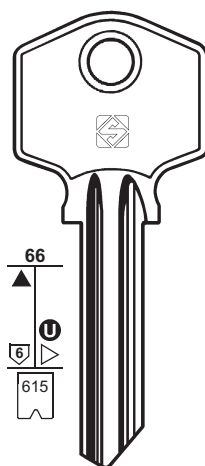

CA11

CA11R ▲

..... 0123456
..... 400001-435886

AUBERT - FO

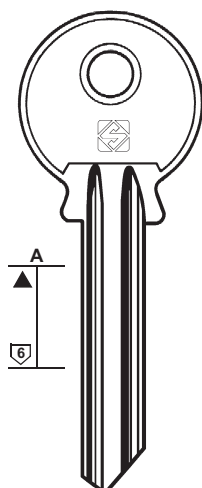

CA10

CA10R

ARNOV
FO - MONOBLOC

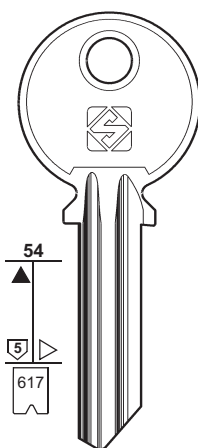

CA15

..... 81000-88179

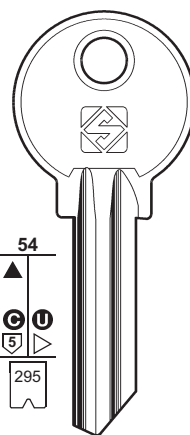

CA2R

CA2

160 ... 000-999
16 ... 1000-6288

QCP - SIAM

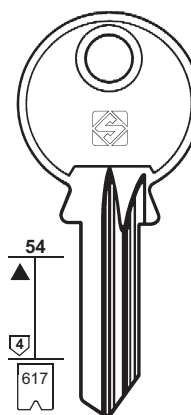

CA7

..... 0-1-2-3-4-5-6
..... 12500-15949

SICMA



202

PER / FOR

ZHONGHENG (PRC)

PER:
FOR:

ZHONGHENG

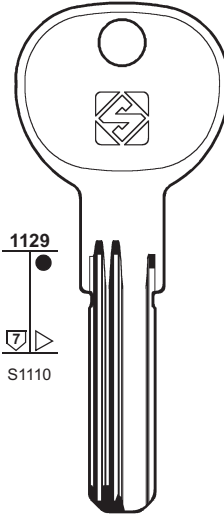

ZH1R



PER:
FOR:

PER:
FOR:



Dimple Keys
Chiavi punzonate
Bohrmuldenschlüssel
Clés à points
Llaves de seguridad
Chaves de pontos

PER:
FOR: **3M**

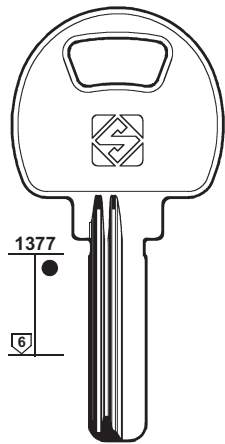

1377
6

TRM1R

ABUS

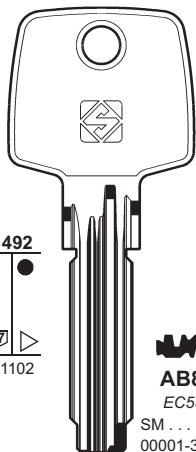

1492
6+7
S1102

AB74
D6

AB84
EC550
SM.
00001-30000

AB77
D8

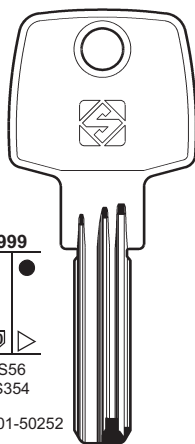

999
10

AB40
AAL

S56
S354
- 00001-50252

EXTRA-CLASSE

CISA - BRICARD

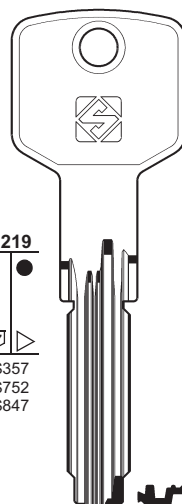

1219
6+7
S357
S752
S847

AB48
D6

..... 000001-168000
- 00001-50252
..... (XN005710) 1-38832

NEW ASTRAL



205

PER / FOR

3M (PRC)

ABUS (D)
CISA
BRICARD
+ CISA (207)

AGA (E)
CASAS
COLOMENCA
FB
SERRALLER
TERCA

AGB (I)

PER:
FOR: **ABUS**

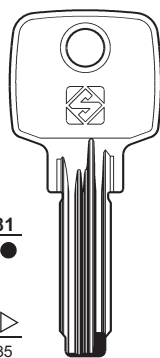

1481
5
S635
S846

AB62
EC75

..... 00001-10000
D8 0000-9999

mm 30-40-50

AGA

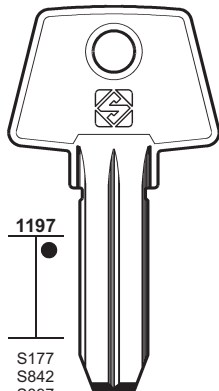

1197
S177
S842
S897
S898
S972

AGA7

..... 1-2-3-4-5

COLOMENCA - FB
SERRALLER - TERCA

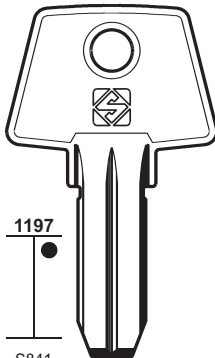

1197
S841
S895
S896

AGA9

CASAS

AGB

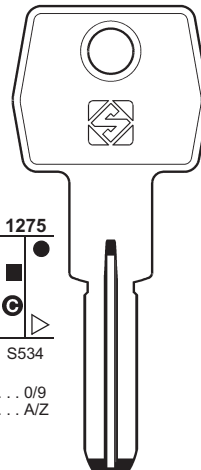

1275
S534

AGB5

SCUDO 9000

..... 0/9
..... A/Z

PER:
FOR: **AGB**

AGB

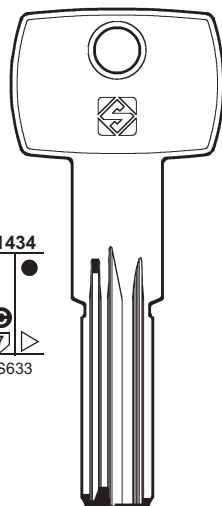

1434
C
7
S633

AGB8

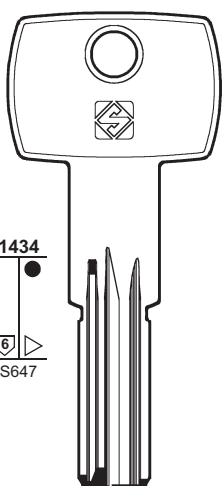

1434
6
7
S647

AGB9

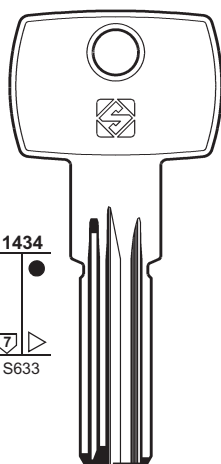

1434
7
S633

AGB6
SCUDO 7000

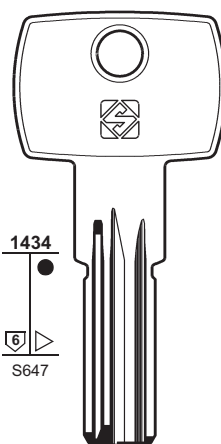

1434
6
S647

AGB7
SCUDO 5000

SCUDO

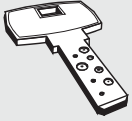

206

PER / FOR

AGENT (J)

ALA (I)
KESO (215)

AL AHRAM (ET)

ALPHA (I)

AMIG (E)

APEKS (RUS)

ATRA (I)
ISEO (214)

AZBE (E)
CAVERS

BAODEAN (PRC)

BASI (D)
SATURN (220)

BEY (TR)

BLINKY (PRC)

BÖRKEY (D)
KABA (214)

PER: FOR:	AGENT	AL AHRAM	ALPHA	AMIG
	 1006 S727	 1514	 1121	 1026
	 AGN1	 AHR2	 ALP16	 AMG1R

PER: FOR:	APEKS		AZBE		
	 1026 S798	 1026	 1054 S51 S84 S480 S481 5+4+4	 1054 S166 S167	 1198
	 APK2R	 APK3R	 AZ6 HS-4	 AZ6R HS-6	 AZ7 HS-6
			CAVERS	CAVERS	

PER: FOR:	BAODEAN	BEY		BLINKY
	 1577	 1130	 1577	 1346
	 BAE1	 BEY1R	 BEY2R	 BNK1

PER:
FOR:

BRICARD

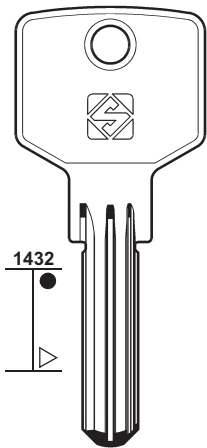

1432

..... 000001-049000
..... 050000-106238

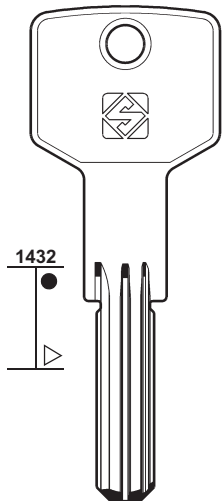

1432

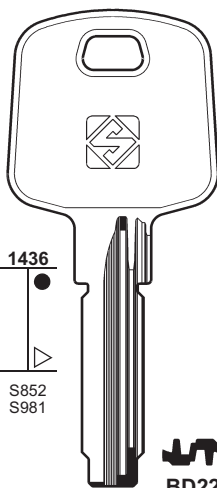

1436

S852
S981

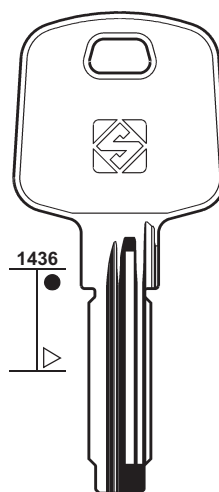

1436

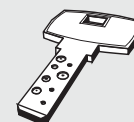

207

PER / FOR

BRICARD (F)
+ ABUS (205)
+ CISA (207-208)

BSS (SRB)
+ URBIS (222)

BULAT (PRC)

BULLOCK (I)
+ ZADI (224)

BURG (D)

CASAS (E)
+ AGA (205)

CAS-CISMA (I)

CAVERS (F)
+ AZBE (206)
+ SPIDER (220)

CAYS (E)

CES (D)

CIERRA SOLA (RA)

CISA (I)
ABUS
BRICARD
+ ABUS (205)

PER:
FOR:

BULAT

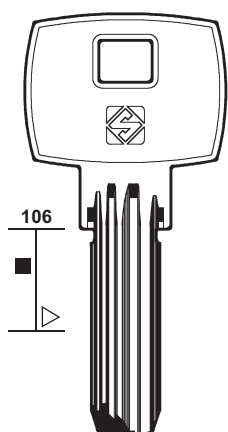

106



BURG

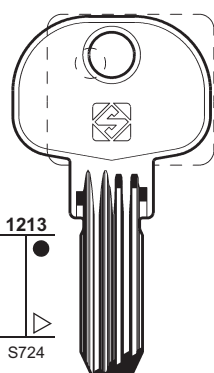

1213

S724

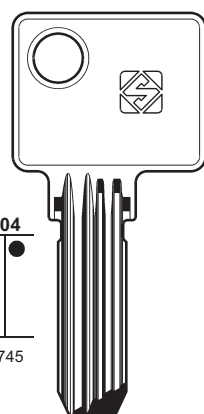

804

S745



CAS-CISMA

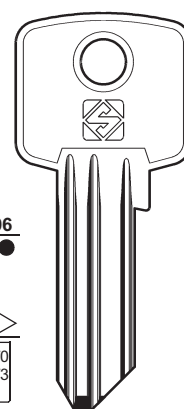

1396

1470
2773



..... 12345678AB 12345678

PER:
FOR:

CAYS

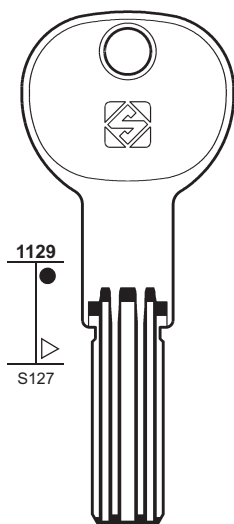

1129

S127



CES

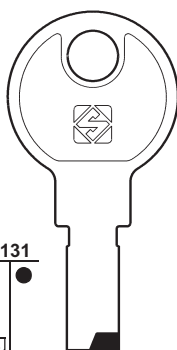

1131

S914

MS... 1-20



CIERRA SOLA

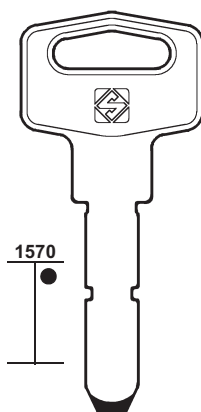

1570



CISA

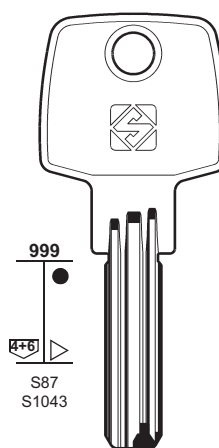

999

S87
S1043

A/Z A/Z A/Z
000001-030198



ABUS - BRICARD

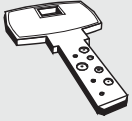

208

PER / FOR

CISA (I)
BRICARD
+ ABUS (205)

CITY (F)
ISEO (213-214)

CODEM (F)
FTH (212)

CODKEY (IL)
SPIDER (220)

COLOMENCA (E)
AGA (205)

CORBIN (I)
+ DOM (209-210)

CVL (E)

DAF (TR)

DECAYEUX (F)
PICARDIE (219)

DEFEND LOCK (CZ)

PER:
FOR:

CISA

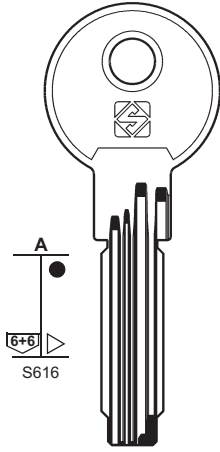

ASIX

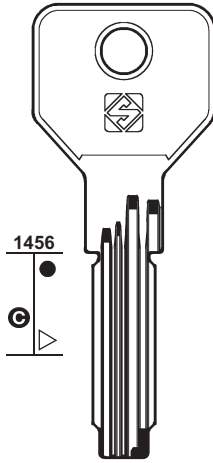

ASIX

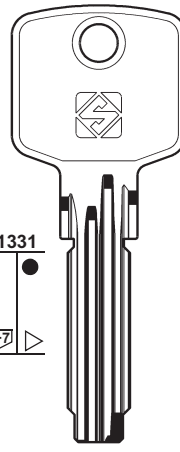

NEW ASTRAL

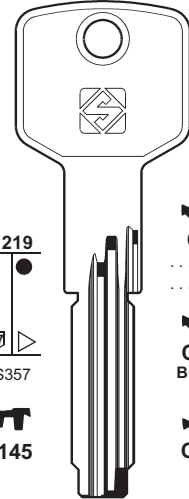

(W08)
CS62 (XN008710) 1-11808
(XN005710) 1-38832

(W05)
CS115 BRICARD



NEW ASTRAL

PER:
FOR:

CISA

CORBIN (I)

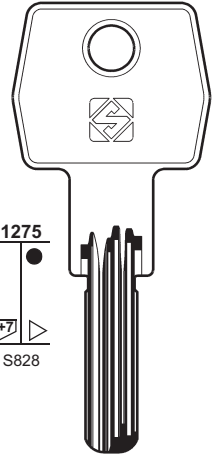
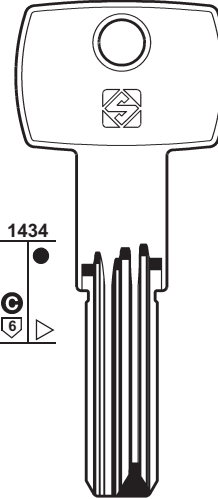
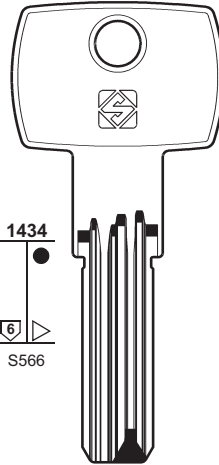
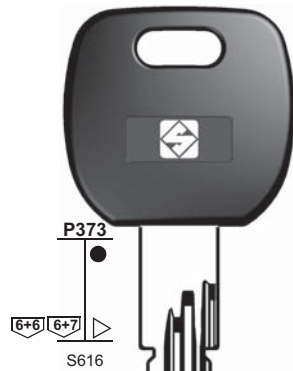

EURO STAR PLUS

PER:
FOR:

CVL



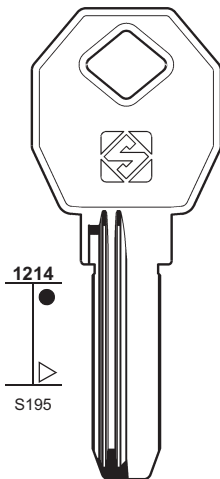

DAF

DEFEND LOCK

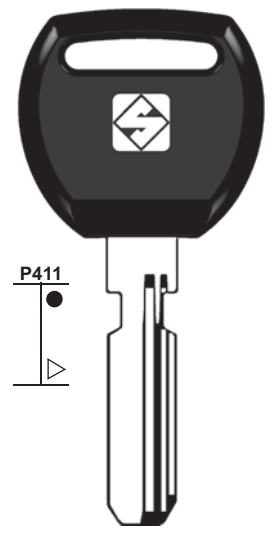
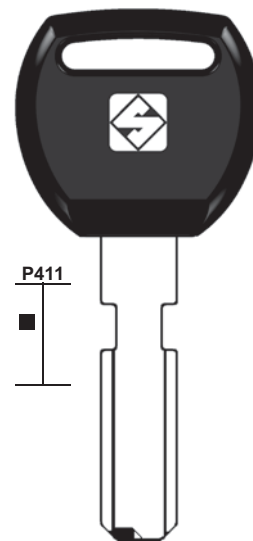
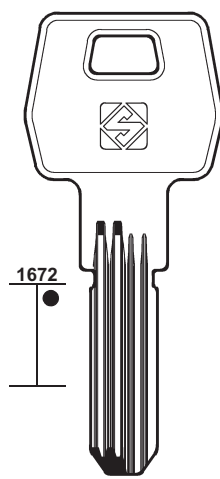

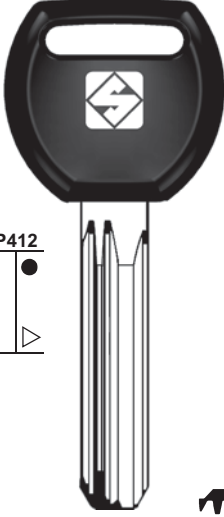
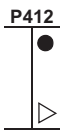
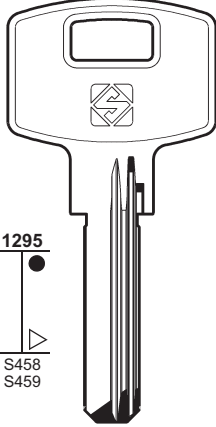
IC 8-7-6-5-4-3

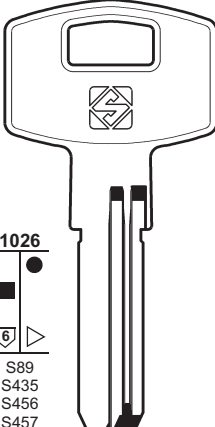

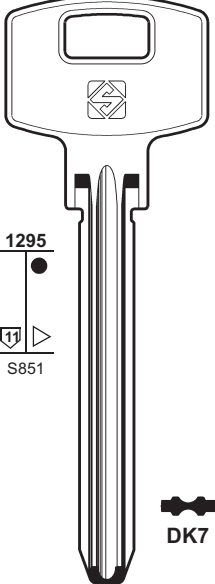
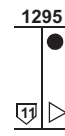







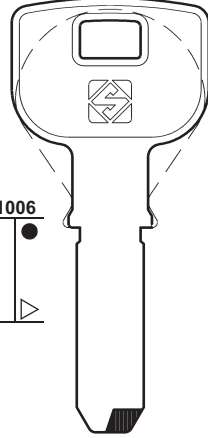

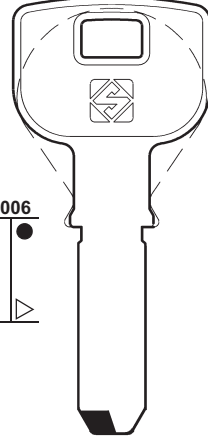

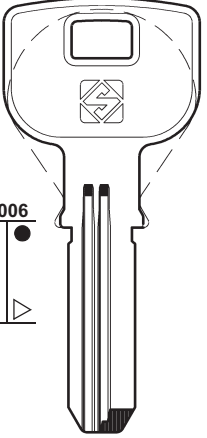

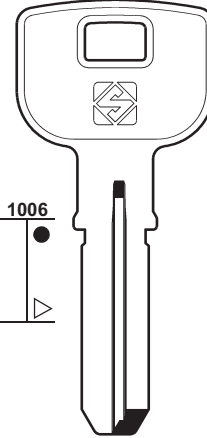

<p>PER: FOR:</p> <p>DEFEND LOCK</p>	<p>DEKABA</p>		
 <p>P412</p>  <p>DFE3RAP</p>	 <p>1295</p>  <p>S458 S459</p> <p>DK1</p> <p>MAUER</p>	 <p>1026</p>  <p>S89 S435 S456 S457 S849</p> <p>DK3 E2</p> <p>DK6 E2</p> <p>MAUER</p>	 <p>1295</p>  <p>S851</p> <p>DK7</p> <p>MAUER</p>

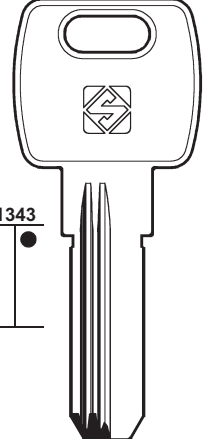

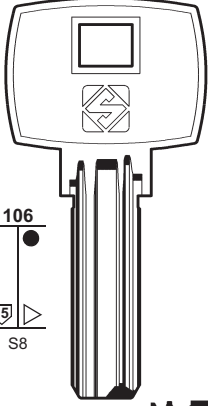
209

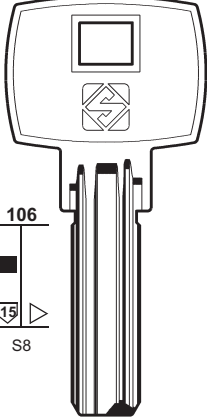
- PER / FOR
- DEFEND LOCK** (CZ)
 - DEKABA** (BG)
MAUER
 - DELCA** (GR)
GEVY
 - DIAM** (F)
LAPERCHÉ (216)
 - DIERRE** (I)
 - DOM** (D)
CORBIN
EMHART
IR
LAPERCHÉ

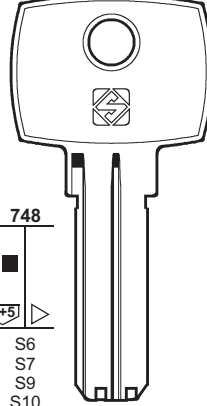
<p>PER: FOR:</p> <p>DELCA</p>			
 <p>1006</p>  <p>DLC1</p>	 <p>1006</p>  <p>DLC1R</p>	 <p>1006</p>  <p>DLC2R</p>	 <p>1006</p>  <p>DLC3</p>
<p>GEVY</p>		<p>GEVY</p>	

<p>PER: FOR:</p> <p>DIERRE</p>	<p>DOM</p>		
 <p>1343</p>  <p>DIR1R</p> 	 <p>106</p>  <p>S8</p> <p>DM64</p> <p>DM118</p>	 <p>106</p>  <p>S8</p> <p>DM120</p> <p>DM122</p>	 <p>748</p>  <p>S6 S7 S9 S10 S45 S118 S178</p> <p>DM49</p> <p>DM53</p>
	<p>CORBIN - EMHART IR - LAPERCHÉ</p>		<p>CORBIN</p>
<p>Copyright by Silca S.p.A. 2013 - All rights reserved</p>			

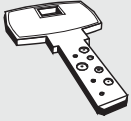

210

PER / FOR

DOM (D)
CORBIN
EMHART
MOREAUX
STS

DOMUS (GR)

DORSET (IND)
KABA (214)

ELCA (D)
STS
TESA
VIRO

ELZETT (H)

EMHART (USA)
DOM (209-210)

ESAFE (E)
UCEM (222)

PER:
FOR:

DOM

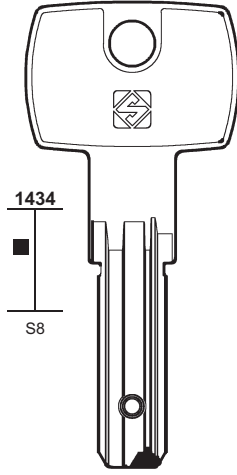

1434
S8

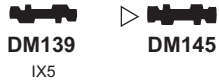

DM139 IX5 DM145

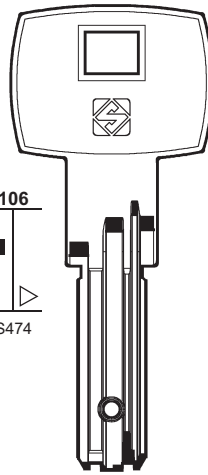

106
S474



DM144 IX6

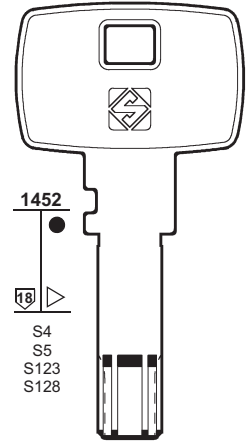

1452
S4
S5
S123
S128



DM22TVPX DM22TV5X

STS

PER:
FOR:

DOM

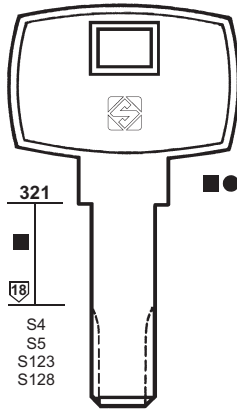

321
S4
S5
S123
S128



DM22



DM22TV5 DM22TV10



DM22TV4 DM22TV9



DM22TV3 DM22TV8



DM22TV2 DM22TV7



DM22TV1 DM22TV6



DM22TVP

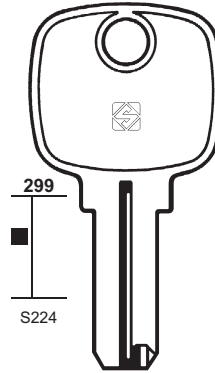

299
S224



DM21
..... 0-1-2-3-4-5

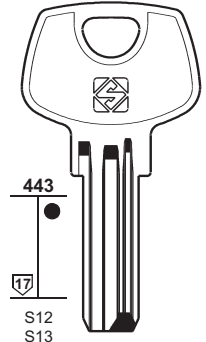

443
S12
S13



DM138



DM55
2Y



ALARM

CORBIN - EMHART

MOREAUX

PER:
FOR:

DOM

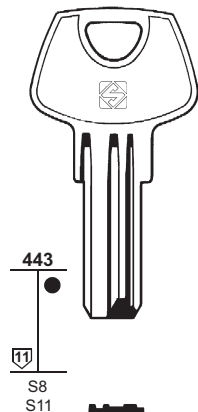

443
S8
S11



DM128



DM58



ALARM

DOMUS (GR)

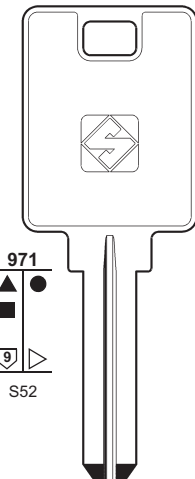

971
S52



DS6 DS7

ELCA

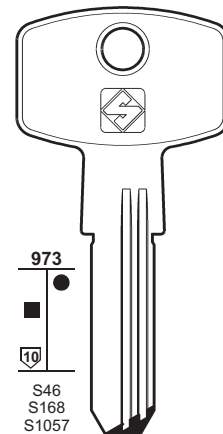

973
S46
S168
S1057



EC5

ELZETT

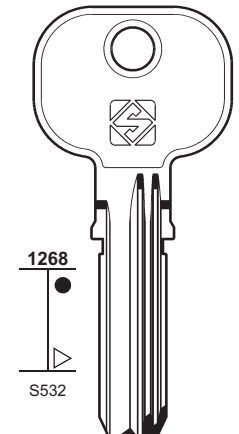

1268
S532

.....
0-1-2-3-4



EL9

STS - TESA - VIRO

PER: EURO LOCKS
FOR:

EZCURRA

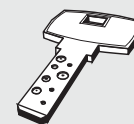

211

PER / FOR

EURO LOCKS (B)

EZCURRA (E)
+ SEA (220)

FAC (E)

FAVOUR (DZ)

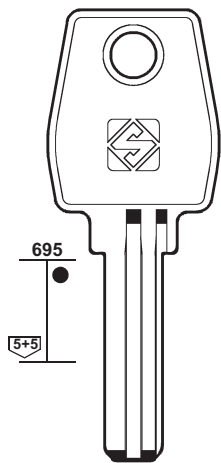

EU17

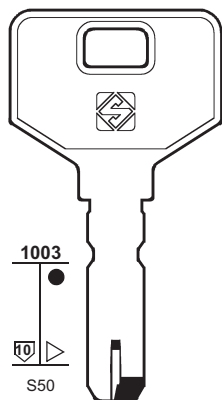

EZ3
DS10

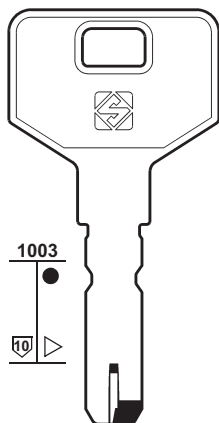

EZ3X
DS10

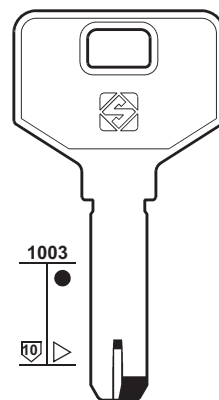

EZ6
DS15

PER:
FOR:

EZCURRA

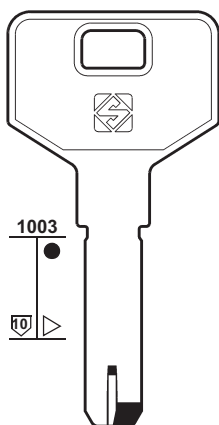

EZ6X
DS15

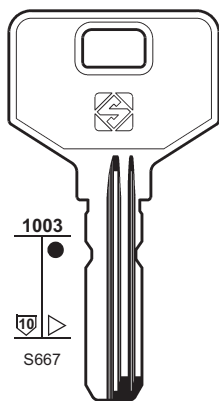

EZ4
DS10-E

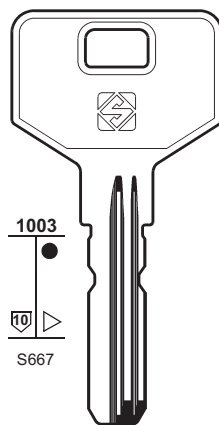

EZ4X
DS10

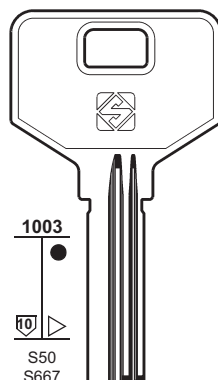

EZ5
DS15-E

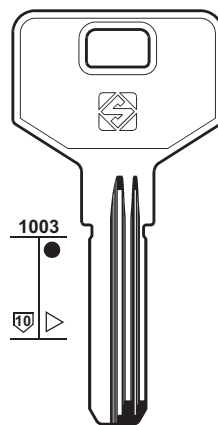

EZ5X
DS15

PER:
FOR:

FAC

FAVOUR

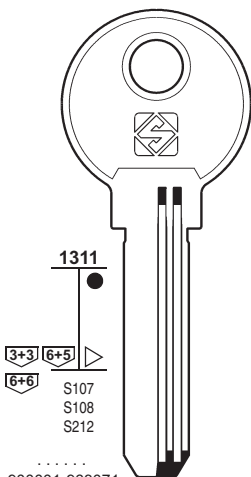

S107
S108
S212
.....
900001-963071

FAC15

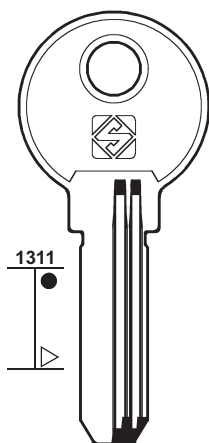

FAC31

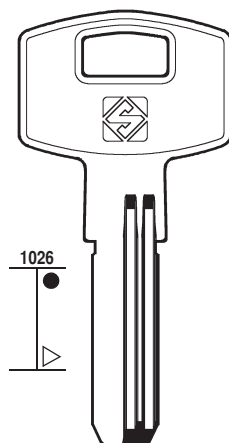

FVR1

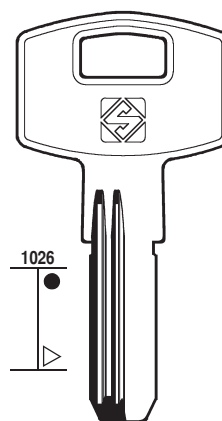

FVR2R

FVR4R

FVR3

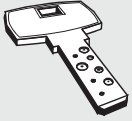

212

PER / FOR

FAYN (TR)

FB (E)

👁️ AGA (205)

FCV (D)

KFV

VBH

FEB (I)

👁️ VIRO (223)

FIAM (I)

+ 👁️ KESO (215)

FTH (F)

CODEM

GOTTA

IFAM

ITO

KARO

SP

TOVER

YALTRES

GARRISON (GB)

👁️ MUL.T.LOCK (218)

PER:
FOR: **FAYN**

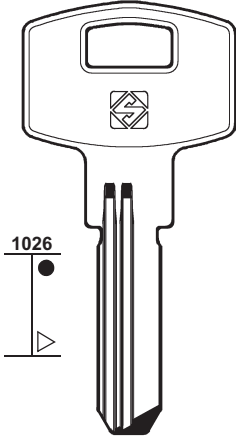

1026

FY1R

FCV

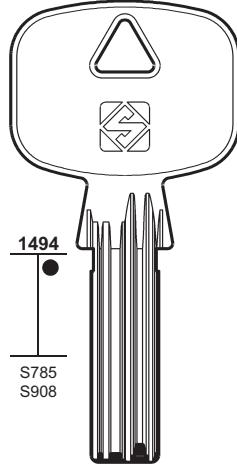

1494
S785
S908

FV4

KFV - VBH

FIAM

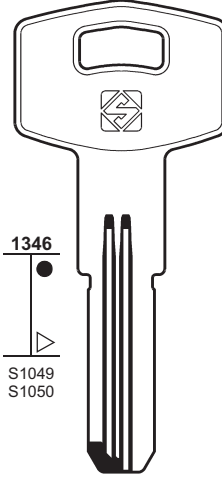

1346
S1049
S1050

FI3R

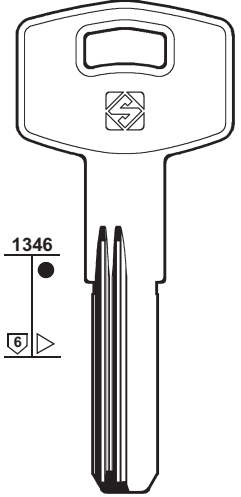

1346
6

FI4R

PER:
FOR:

FTH

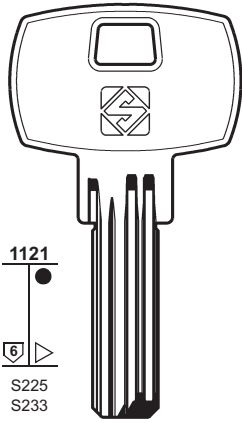

1121
S225
S233

FH12

CODEM - GOTTA - ITO
TOVER - YALTRES

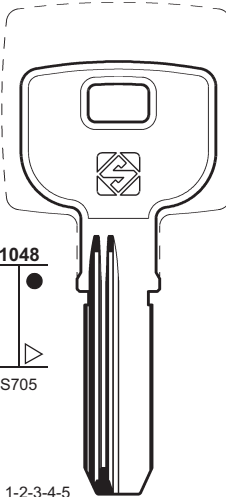

1048
S705

FH17R

IFAM - KARO

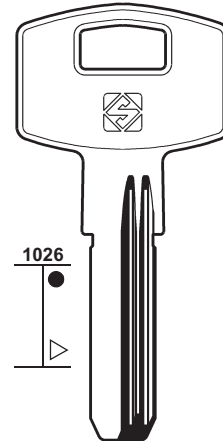

1026

FH32

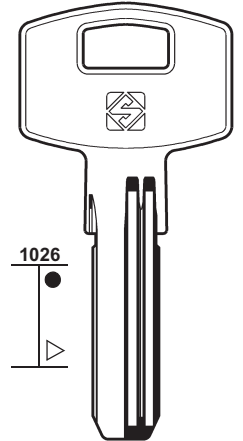

1026

FH33

SP

PER:
FOR:

FTH

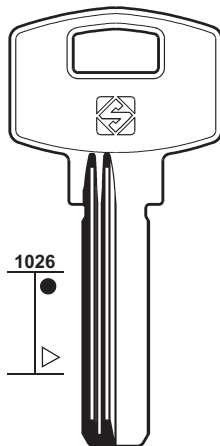

1026

FH34R

SP

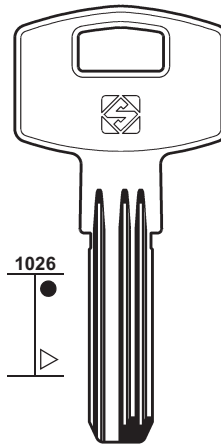

1026

FH35

SP

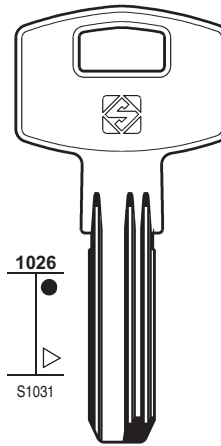

1026
S1031



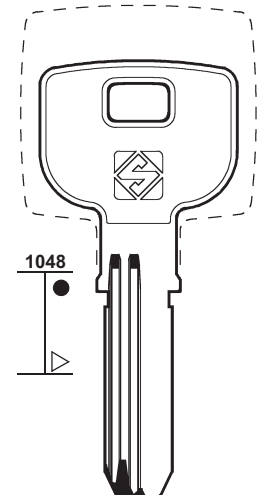



FH36

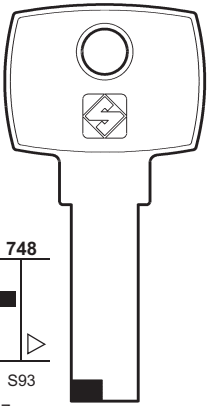
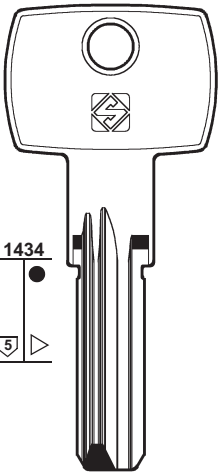
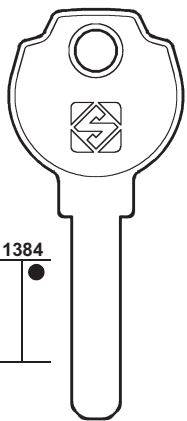
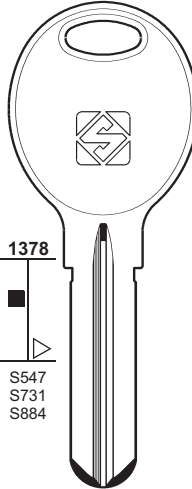
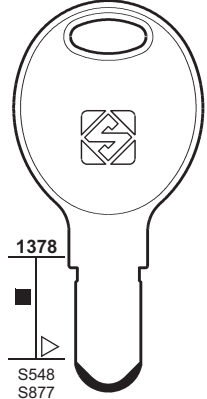

1048







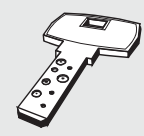

FH37R





SP



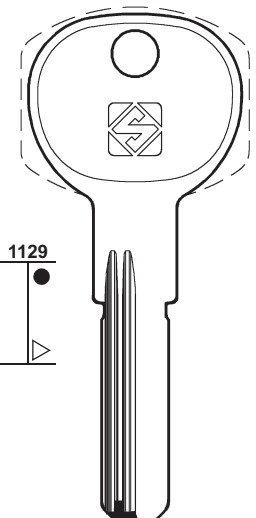
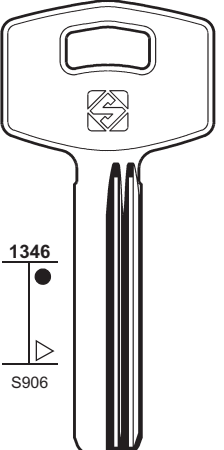
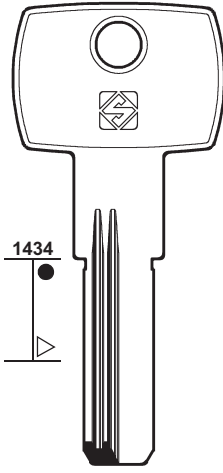
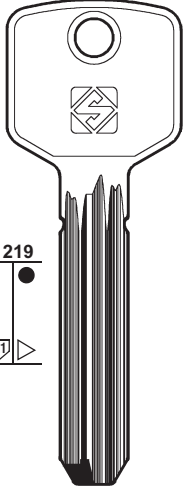

PER: FOR:	GEGE	GEVY	GIUSSANI	GOAL
				 
	748 S93 Z... 101-120	1434 5	1384	1378 S547 S731 S884 1378 S548 S877
	 GE57	 GVV1R	 GS17	 GO6  GO7
		MOTTURA		

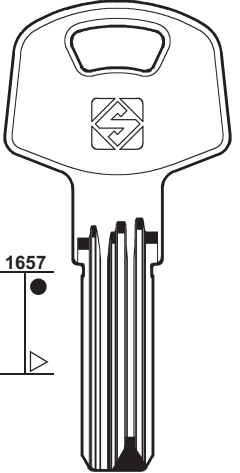
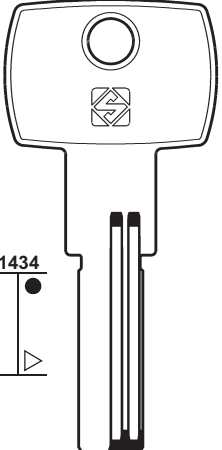
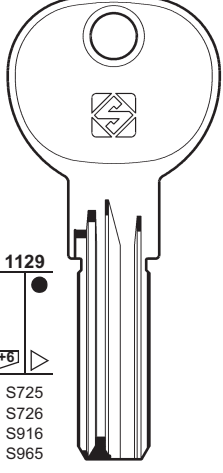
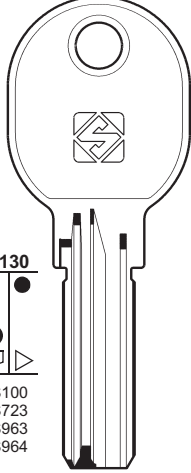

213

PER / FOR
GEGE (A)
GEVY (GR) MOTTURA +  DELCA (209)
GIUSSANI (I)
GOAL (J)
GOTTA (D)  FTH (212)
GP (I)
GRIFO (RC)
HASLER (D)  SEA (220)
HB (I)  LEGALLAIS (216)
HOK (TR)
HOOPLY (PRC)  WANJIN (223)
HUGO (D)
ICSA (I)  LINCE (216)
IFAM (E)  FTH (212)
I.R. (F) +  DOM (209)
ISEO (I) CITY VACHETTE +  UCEM (222)

PER: FOR:	GP	GRIFO	HOK	HUGO
				
	1129	1346 S906	1434	1219
	 GPI1	 GF1	 HOK1R	 HGO1R

PER: FOR:	IFAM	I.R.	ISEO
			 
	1657	1434	1129 S725 S726 S916 S965 1130 S100 S723 S963 S964
	 IF14	 IR1	 IE14 R11  IE15 R6
			EDL CFA 1-27065 EDL 1-350589 ABL 1-015328 ACY 1-015328 AGL 1-015328 ABF 1-015694

CITY - VACHETTE

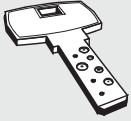

214

PER / FOR

ISEO (I)

ATRA

CITY

+ UCEM (222)

ITO (TR)

+ FTH (212)

JPM (F)

+ KESO (215)

KABA (CH)

BÖRKEY

DORSET

LÄSBOLAGET

PICARD

KAKEN (ROK)

PER:
FOR:

ISEO

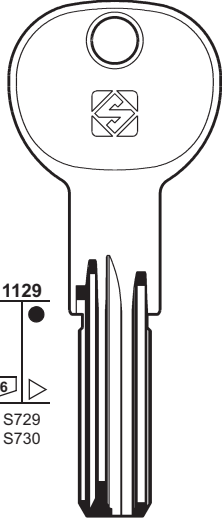

1129
5+6+6
S729
S730

AAC 1-015694
DAA 1-348933



IE26

ATRA - CITY

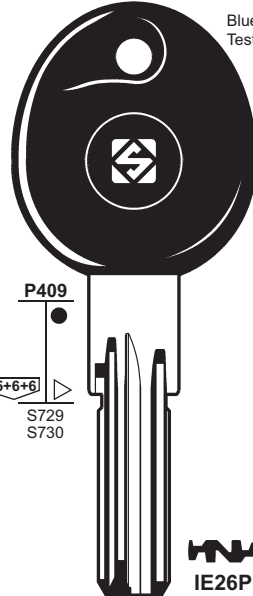

Blue head
Testa blu

P409
5+6+6
S729
S730



IE26P

AAC 1-015694
DAA 1-348933

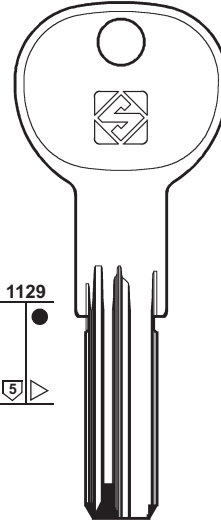

1129
5
S729
S730



IE30

ITO

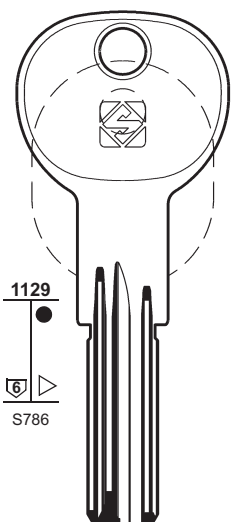

1129
6
S786



IO1

PER:
FOR:

KABA

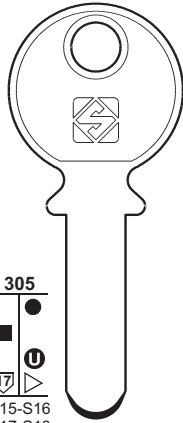

305
S15-S16
S17-S18
S53-S58
S59-S61
S114

PH
0001-9000
... 1-200



KA1 mm 2
8

LÄSBOLAGET

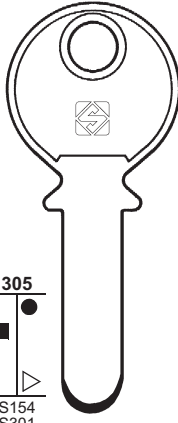

305
S154
S301
S304
S483

KA2 mm 2,5
20

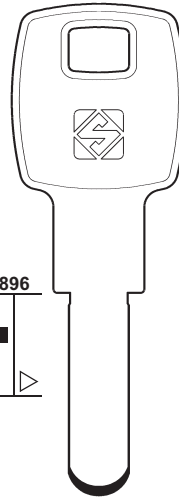

896

KA7 mm 2,5

PICARD

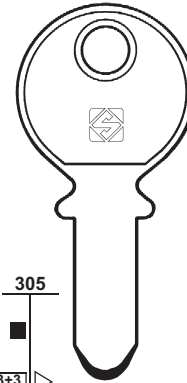

305
3+3+3
S200

KA6

BORKEY

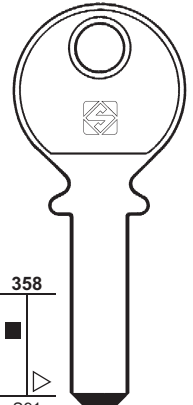

358
S91
S92

KA3
MINI KABA

PER:
FOR:

KABA

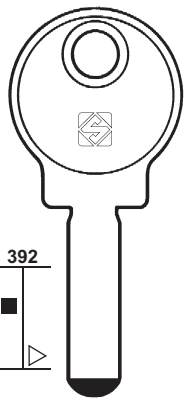

392

KA4

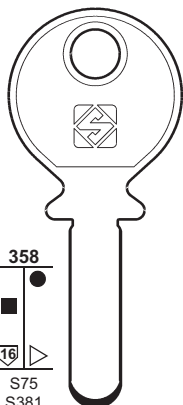

358
16
S75
S381
S384
S387

KA5
GEMINI

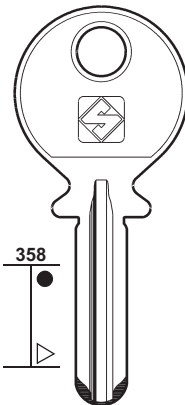

358

KA9

DORSET

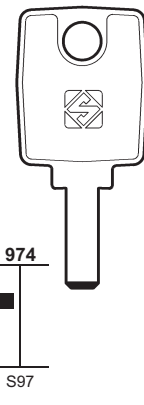

974
S97

KA8
MICRO KABA

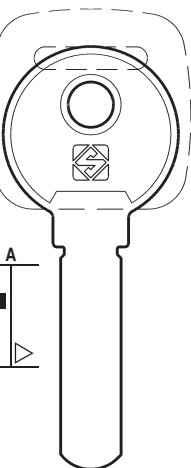

A

KAK1

PER:
FOR:

KALE

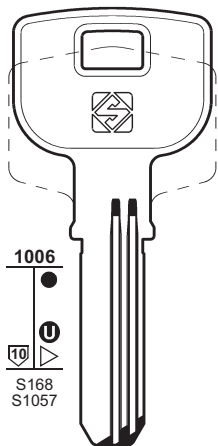

1006
S168
S1057

KLE1 **KLE4**

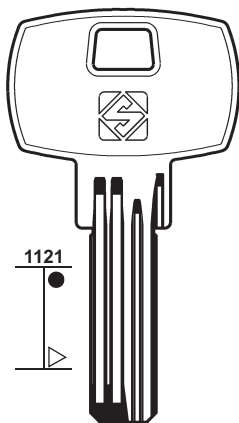

1121

KLE2R

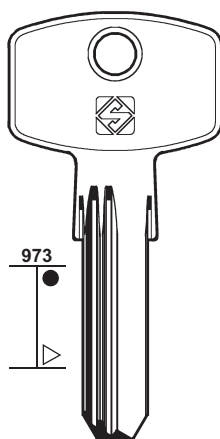

973

KLE8R

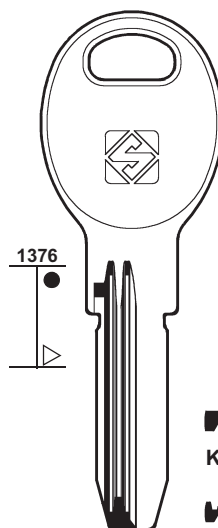

1376

KLE9R
KLE10R

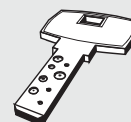

215

PER / FOR

KALE (TR)
+ TESA (221)

KARO (E)
 FTH (212)

KESO (CH)
ALA
FIAM
JPM
LIPS
SARGENT

KFV (D)
 FCV (212)

IMSI (I)
 PERINO PG (219)

JPM (F)
 KESO (215)

PER:
FOR:

KESO

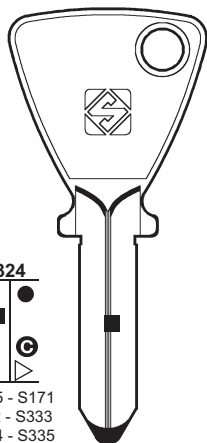

324

S105 - S171
S332 - S333
S334 - S335
S336 - S598
S599 - S600
S601 - S678
S807

KE1

JPM

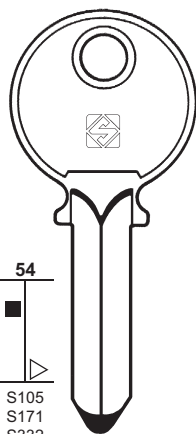

54

S105
S171
S332
S333
S334
S335
S336
S598
S599
S600
S601

KE2

JPM

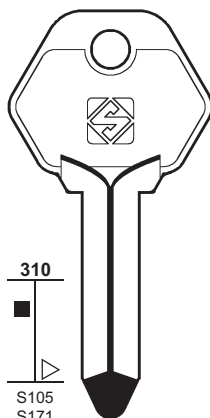

310

S105
S171
S332
S333
S334
S335
S336
S598
S599
S600
S601

KE4

SARGENT

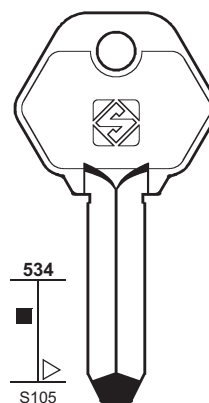

534

S105

LP11

LIPS

PER:
FOR:

KESO

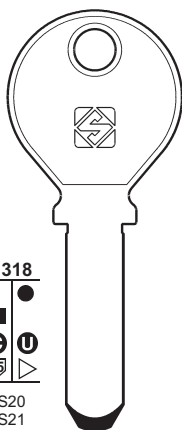

1318

S20
S21
S57
S267
S273
S277
S359

KE3

ALA

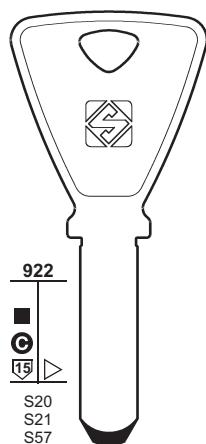

922

S20
S21
S57
S267
S273
S277
S359
S663

KE9
2000

JPM

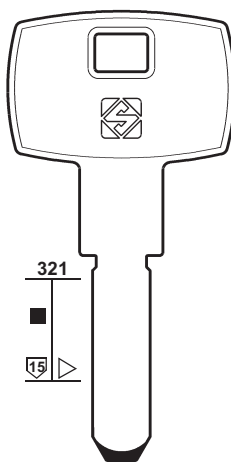

321

S20
S21
S57
S267
S273
S277
S359
S663

KE11

FIAM

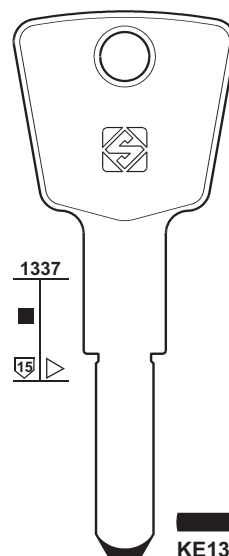

1337

S20
S21
S57
S267
S273
S277
S359
S663

KE13

FIAM

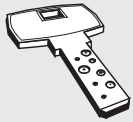

216

PER / FOR

LAPERCHE (F)

DIAM
+ DOM (209)

LÅSBOLAGET (S)

KABA (214)

LEGALLAIS (F)

HB

LINCE (E)

ICSA

LIPS (NL)

+ KESO (215)

LOB (PL)

MCM (217)

LOCKSYS (BG)

MAGNUM (GB)

MASTER (USA)

+ TOVER (222)

MASTER LOCK (PRC)

MAUER LOCKS (BG)

DEKABA (209)

PER:
FOR:

LAPERCHE

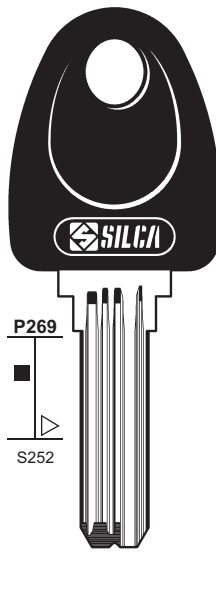
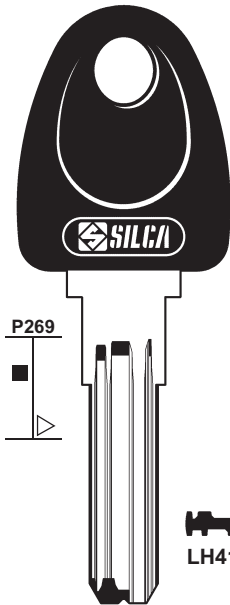

LH41P

DIAM



LH13P



LH14P



LH15P



LH16P



LH17P



LH18P

LEGALLAIS

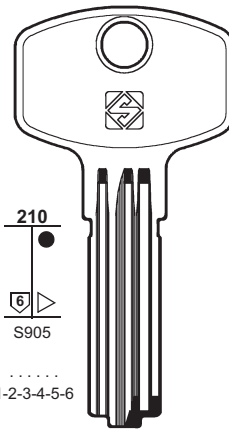

LEA1

HB

LINCE

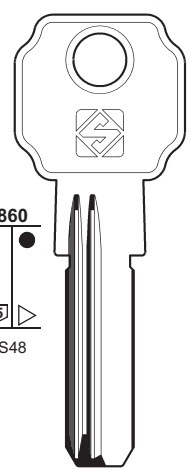

LC14R
X

ICSA

PER:
FOR:

LIPS

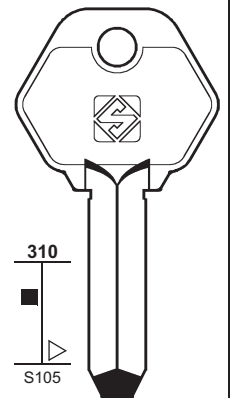

LP11

LOCKSYS

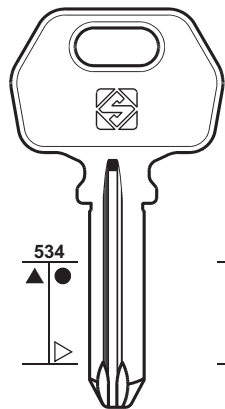

LCK1R

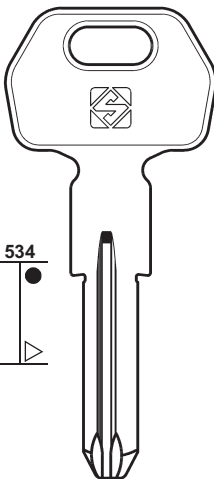

LCK1RX

MAGNUM

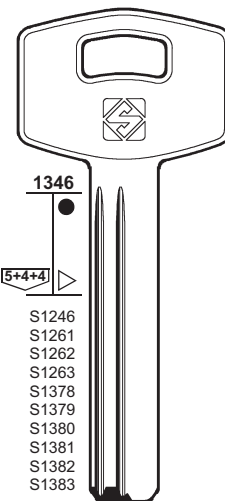

MGN1R

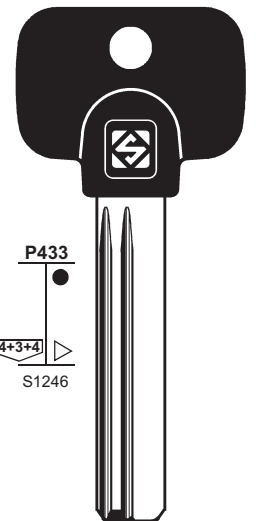

MGN1RP

PER:
FOR:

MASTER

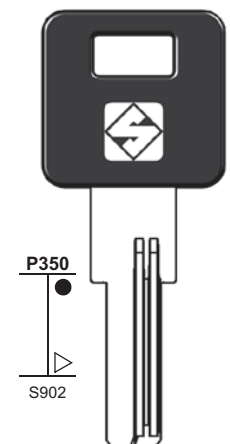

MS20P

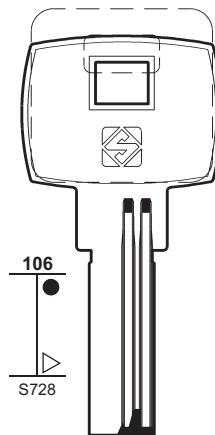

MS22

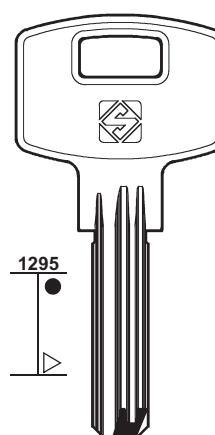

MS23

MASTER LOCK

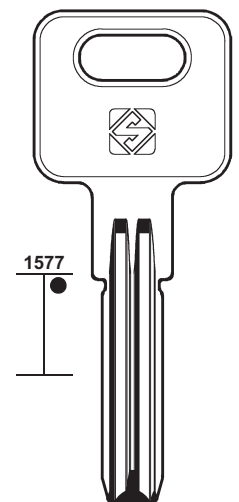

MSL1

PER:
FOR:

MCM

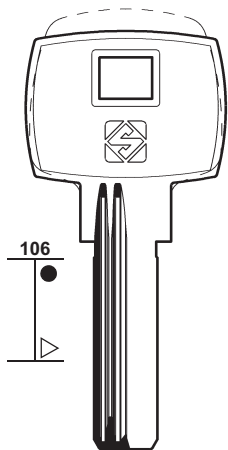

MC14R

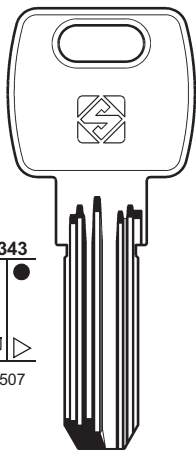

MC15R
E8

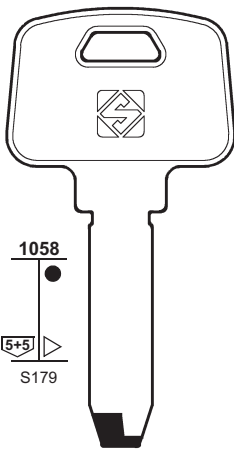

MC9X
4SS

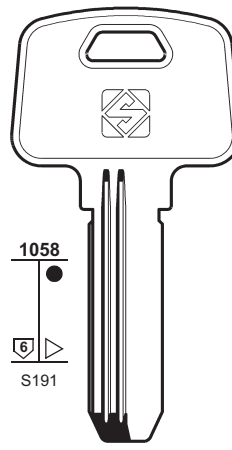

MC10R
4SE

LOB - YETI

TROMER

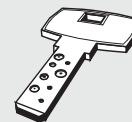

217

PER / FOR

MCM (E)
LOB
TROMER
YETI

MERONI (I)

MEGA (RO)

METAL (BG)

MG (MONTI) (I)

MLM (F)

MODA (F)
PICARDIE (219)

MOREAUX (F)
DOM (210)

MOTTURA (I)
GEVY (213)

MULT-LEI (GR)

PER:
FOR:

MERONI

MEGA

METAL

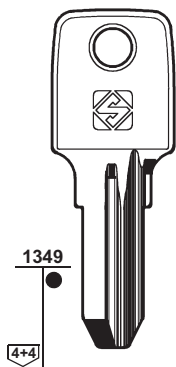

MER38

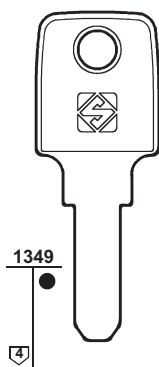

MER39

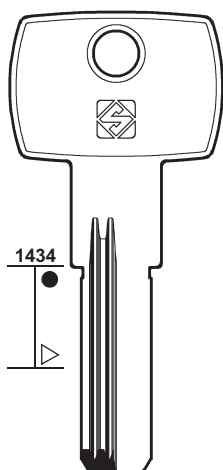

MEG1R

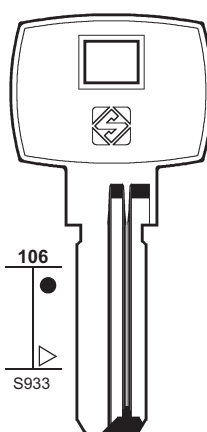

MTA2

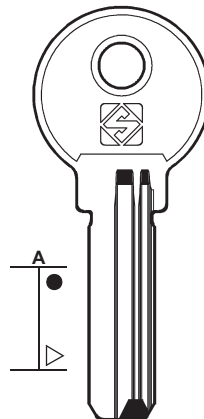

MTA4

PER:
FOR:

MG (MONTI)

MLM

MULT-LEI

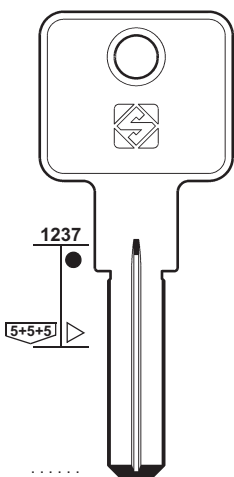

MG8
PBA

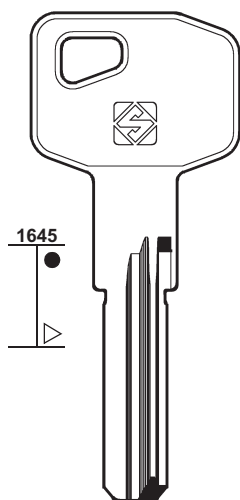

MG9

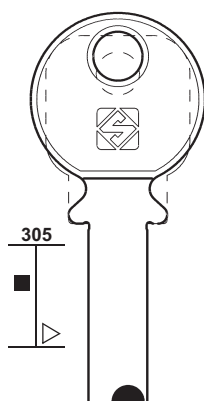

MLM5

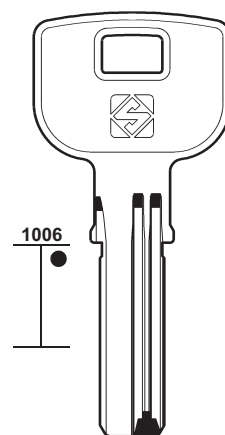

MTL1

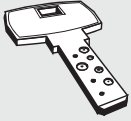

218

PER / FOR

MUL.T.LOCK (IL)
GARRISON
SP

OJMAR (E)

PER:
FOR:

MUL.T.LOCK

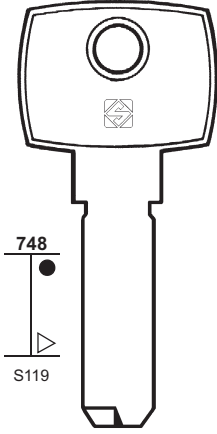

J...
9001-9766

MTK1

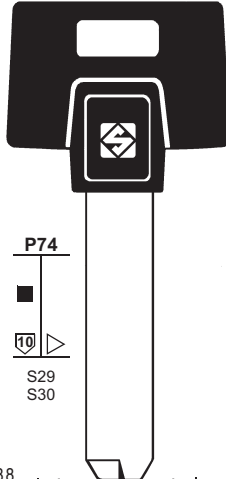

8,8

MTK2P
(006)

ABCD-12345

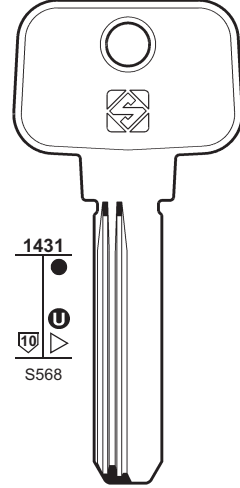

9

MTK3P
(006)

ABCD-12345-01

MTK16
11

MTK15R
66

MTK12R
08
(008)
ABCD-12345

MTK13R
77

MTK11R
06

GARRISON

PER:
FOR:

MUL.T.LOCK

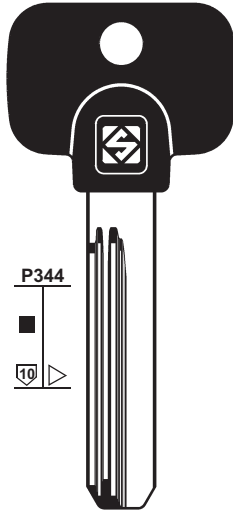

(006)

ABCD-12345-01

MTK10RP

SP

MTK9RP

(006)

MTK8RP
64
ABCD-12345-01

MTK7RP

(006)

50
ABCD-12345-01

MTK4P

(006)

05
ABCD-12345-01

MTK4RP

(005)

06
ABCD-12345

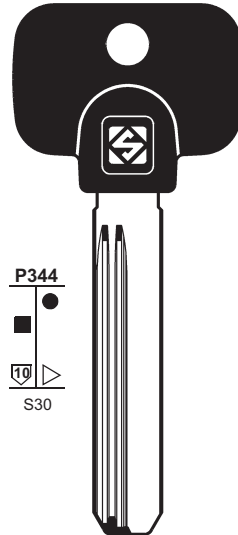

P344

S30

MTK4RPX

06

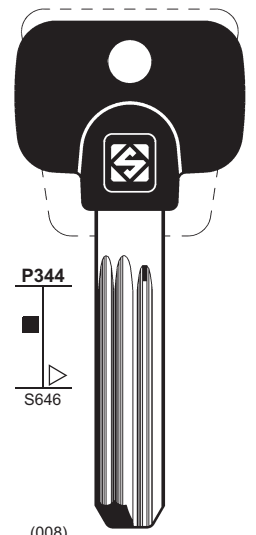

P344

S646

(008)
ABCD-12345

MTK12RP

08

PER:
FOR:

MUL.T.LOCK

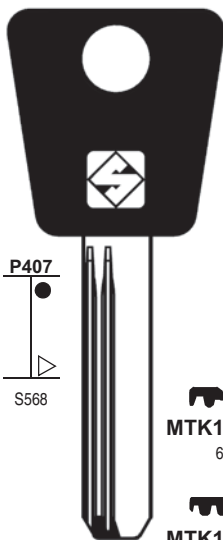

P407

S568

MTK15RAP
66

MTK13RAP
77

GARRISON

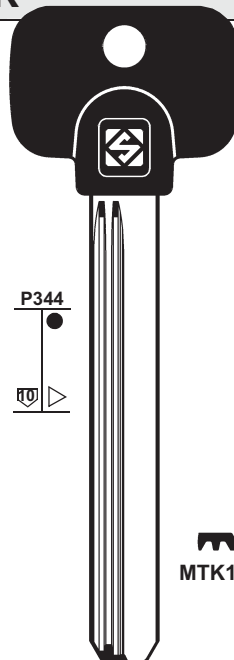

P344

S30

MTK14RP

OJMAR

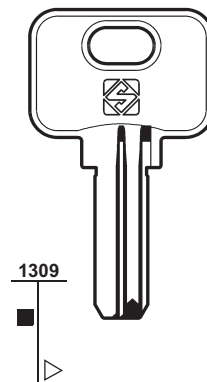

1309

OJ14

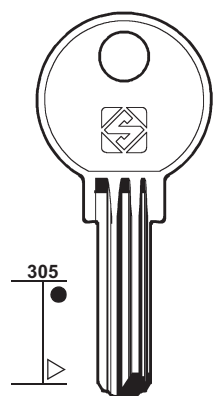

305

OJ18
5-Q4

PER:
FOR:

OMEC

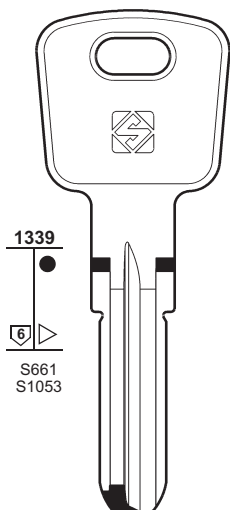

1339
6
S661
S1053



OC3

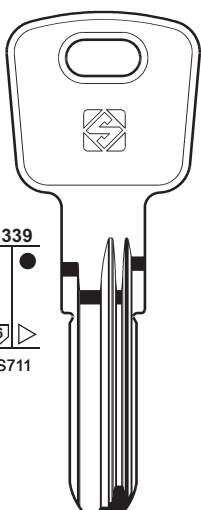

1339
6
S711



OC4

AB.....
0000001-0046656

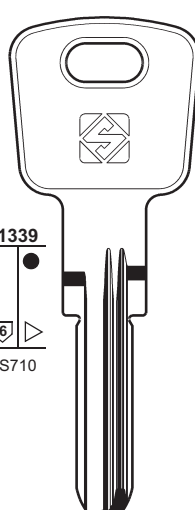

1339
6
S710



OC6

BA.....
0000001-0046656

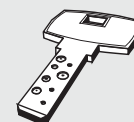

219

PER / FOR

OMEC (I)

PENZA (RUS)

PERINO PG (I)
IMSI

PICARDIE (F)
DECAYEUX
MODA
S & E
STS

PICARD (F)
KABA (214)

POTENT (I)

PREFER (I)

PER:
FOR: PENZA

PERINO PG

PICARDIE

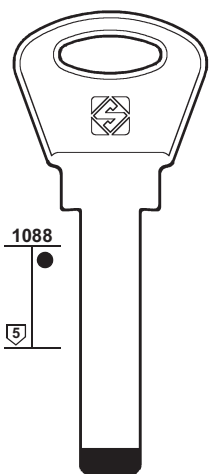

1088
5



BZ3

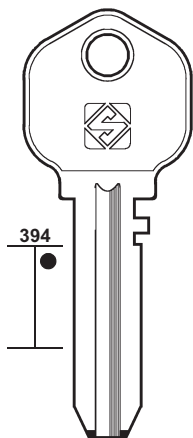

394



PN1

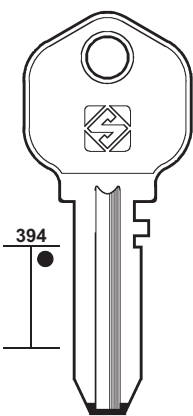

394



PN2

IMSI

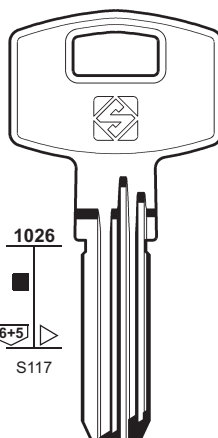

1026
6+5
S117



PIC1

DECAYEUX - MODA
S & E - STS

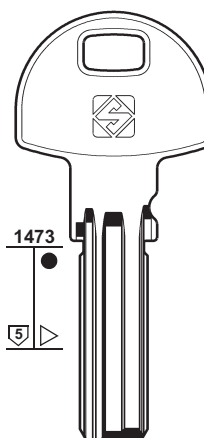

1473
5



PIC2

PER:
FOR: POTENT

PREFER

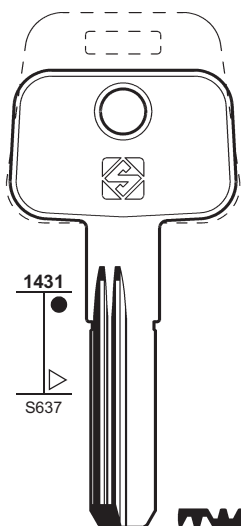

1431
S637



PT4R

..... 1-2-3-4-5

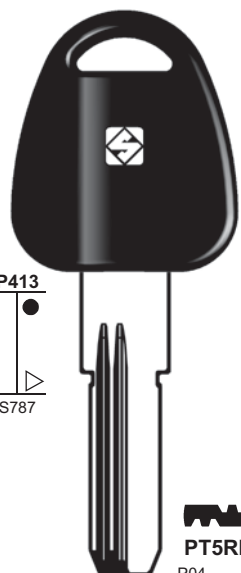

P413
S787



PT5RP

P04.....
1-2-3-4-5-6

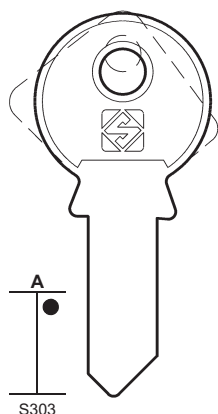

A
S303



PF18

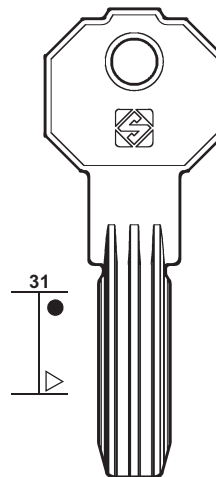

31



PF20

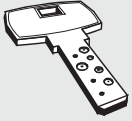

220

PER / FOR

ROSSETTI (R)

S-TECH (GB)

S & E (F)
PICARDIE (219)

SARGENT (USA)
KESO (215)

SATURN (SLO)
BASI

SEA (CH)
EZCURRA
HASLER
VIDMAR

SECUREMME (I)

SERRALLER (E)
AGA (205)

SP (F)
FTH (212)
MUL.T.LOCK (218)

SPIDER (IL)
CAVERS
CODKEY

PER: **ROSSETTI**

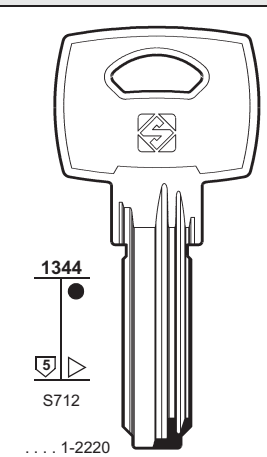

RSS3

PER: **S-TECH**

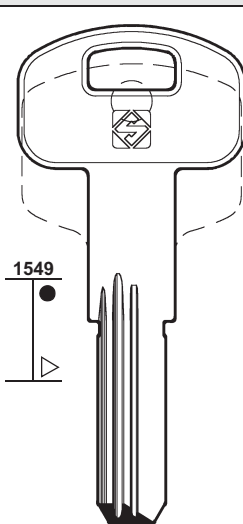

SCH1R

PER: **SATURN**

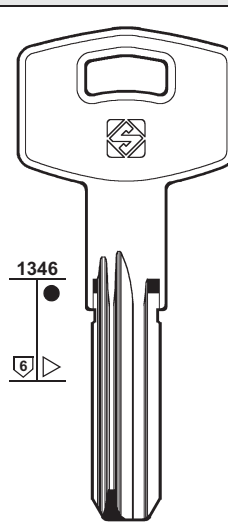

STU6R

BASI

PER: **SEA**

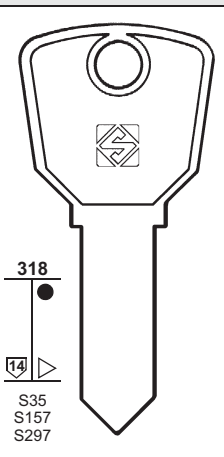

SEB1
20-23

EZCURRA - HASLER

PER: **SEA**

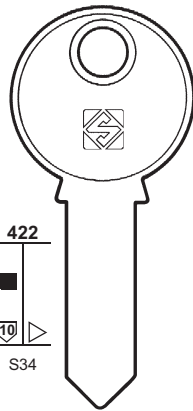

SEB2

EZCURRA - HASLER
VIDMAR

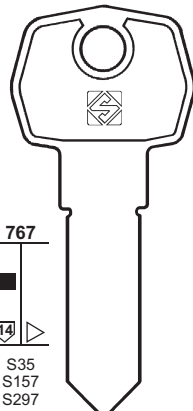

SEB3

20-23

PER: **SECUREMME**

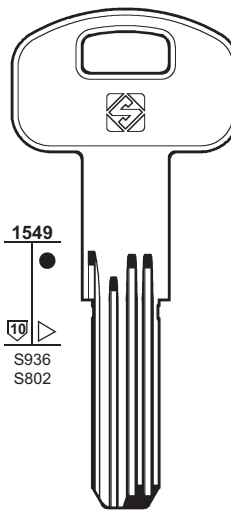

SCM1R

K2

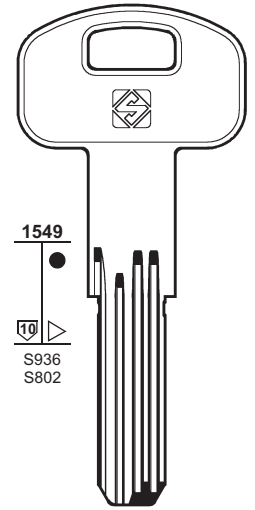

SCM2

K1

PER: **SECUREMME**

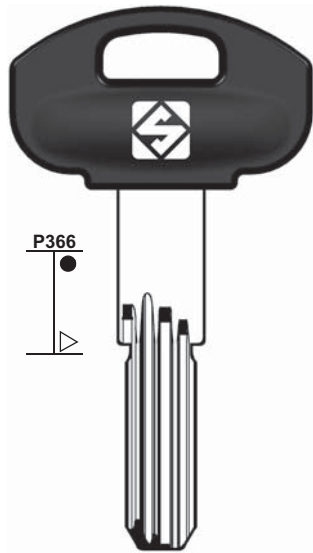

SCM3RP

PER: **SPIDER**

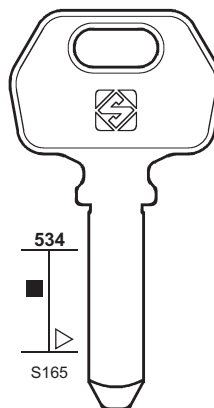





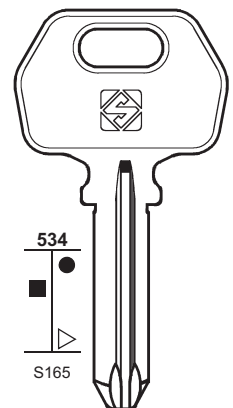

SPR1

CODKEY

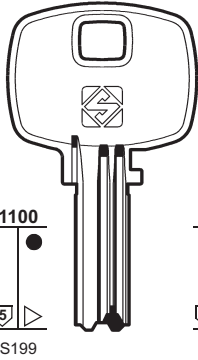
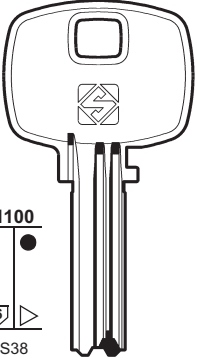
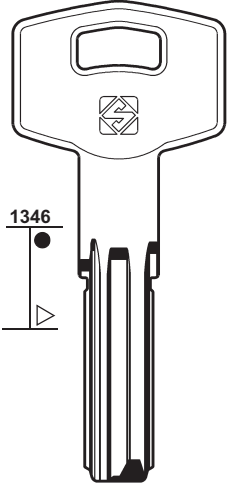
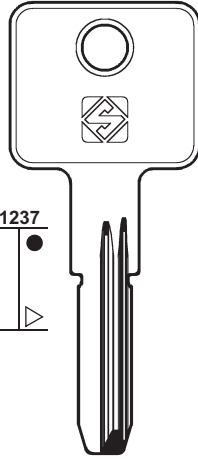
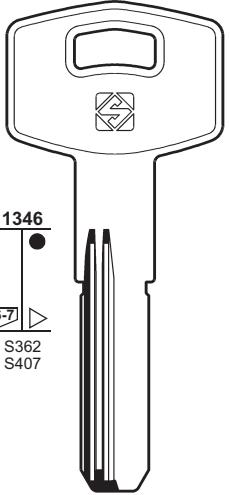
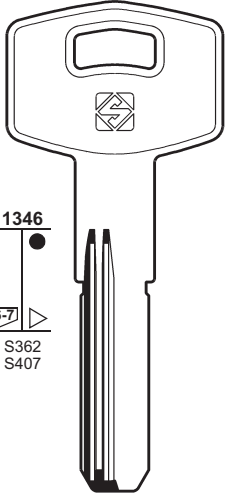





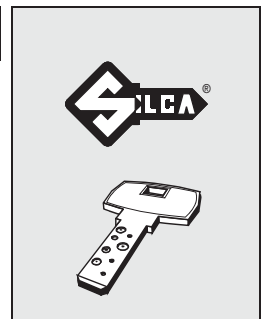

SPR2







CAVERS



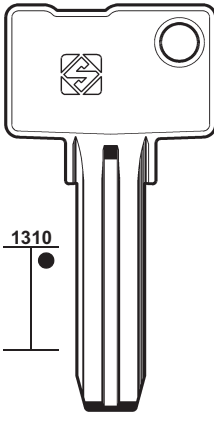
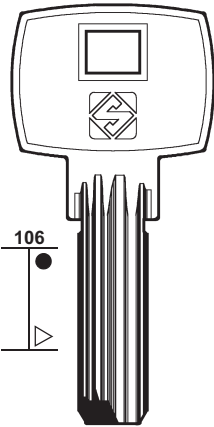
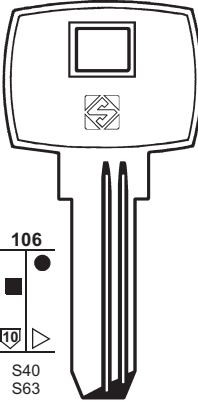
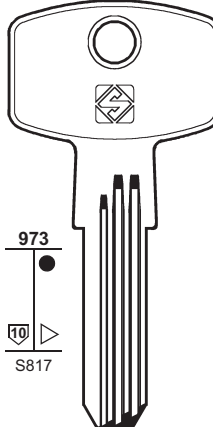
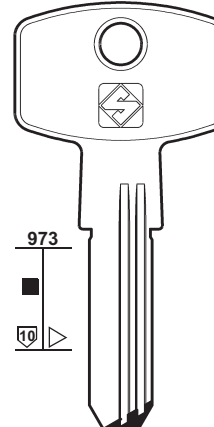
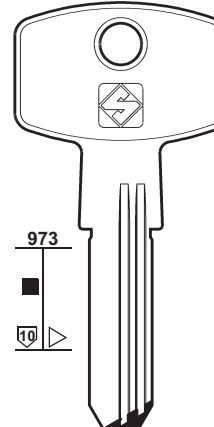

STS			TARONI		
					
1100 ● 5 ▷ S199	1100 ● 6 ▷ S38 S62 S199 S436 P 5001-8030	1346 ● ▷	1237 ● ▷	1346 ● 5-6-7 ▷ S362 S407	
 STS5	 STS6 J K	 STS9	 TAR21	 TAR16	 TAR16R

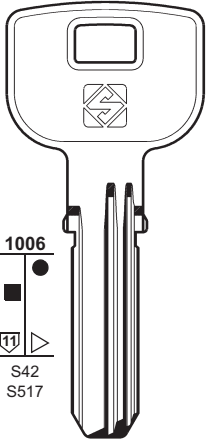
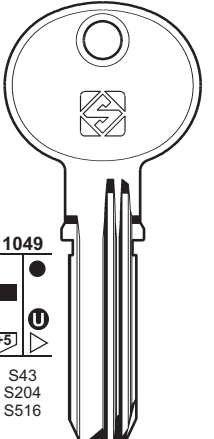
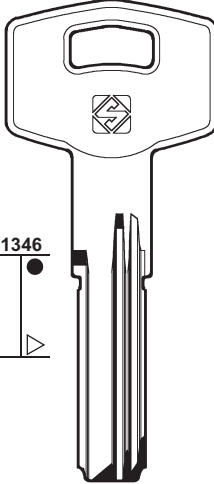
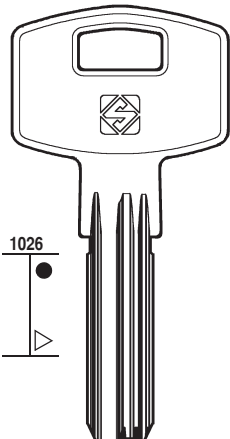

221

- PER / FOR**
- STS (E)**
 - +  DOM (210)
 - +  ELCA (210)
 - +  PICARDIE (219)
 - +  TESA (221)
 - TARONI (I)**
 - TECSESA (E)**
 - TEGASI (GR)**
 - TERCA (E)**
 - +  AGA (205)
 - TESA (E)**
 - KALE
 - STS
 - VIRO
 - +  ELCA (210)
 - THIRARD (F)**

PER: FOR: TECSESA	TEGASI	TESA			
					
1310 ● ▷	106 ● ▷	106 ● 10 ▷ S40 S63	973 ● 10 ▷ S817	973 ● 10 ▷	
 TEC1	 TGS1R	 TE4 T-10	 TE4R	 TE16 T-10P	 EC5
		STS		KALE - STS - VIRO	

TESA			THIRARD
			
1006 ● 11 ▷ S42 S517	1049 ● 5+5 ▷ S43 S204 S516	1346 ● ▷	1026 ● ▷
 TE5 T-80	 TE7 T-60	 TE19	 THR1
STS		STS	

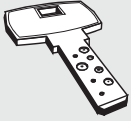

222

PER / FOR

TITAN (SLO)

TOVER (E)
MASTER
TROMER

+ FTH (212)

TROMER (E)

MCM (217)
 TOVER (222)

UCEM (E)

ESAFE
ISEO
YEMAR

URBIS (R)

BSS
YALE

VACHETTE (F)

+ ISEO (213)

PER: TITAN

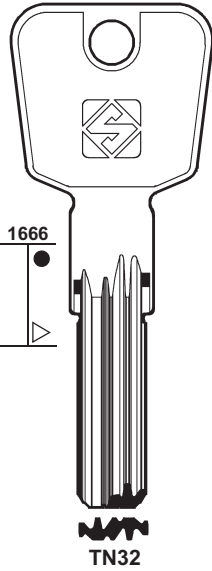

FOR: TOVER

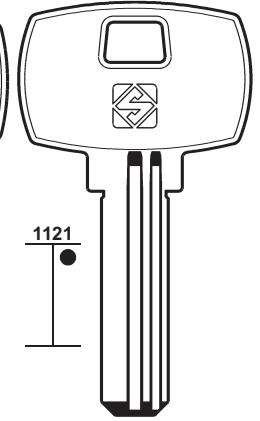
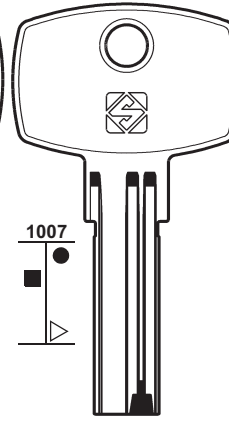
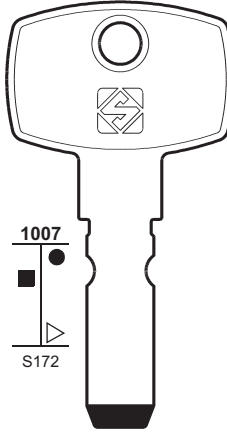
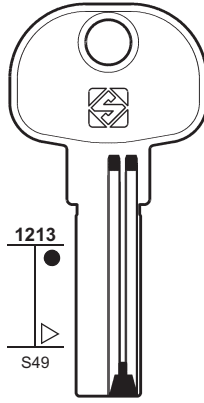

MASTER

TROMER

PER: UCEM

FOR:

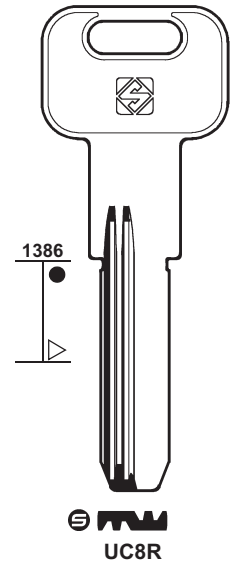
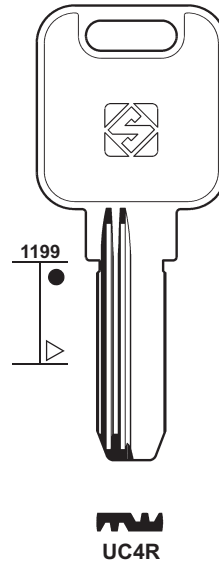
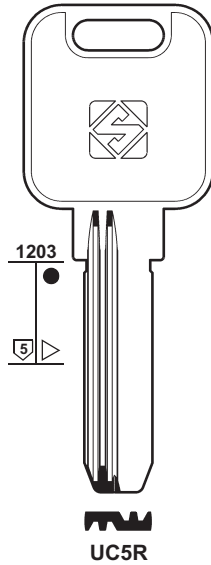
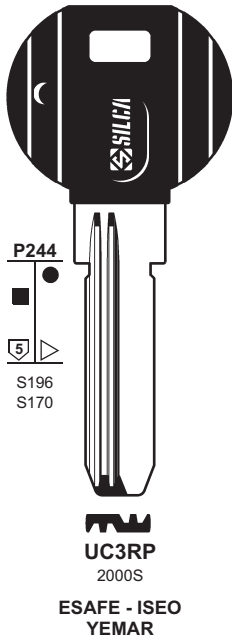

PER: URBIS

FOR:

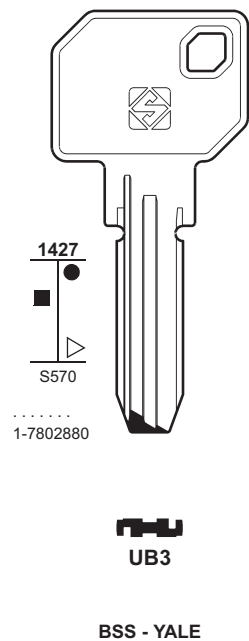



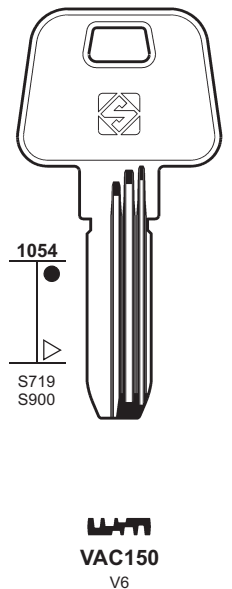
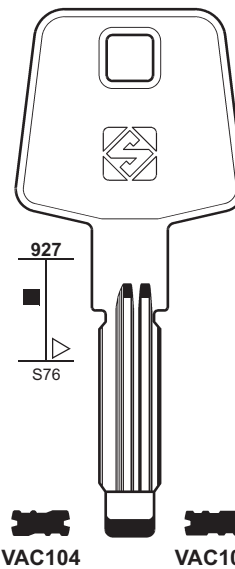
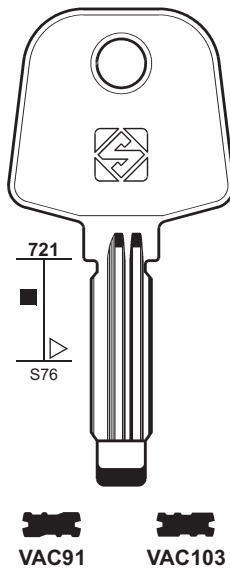



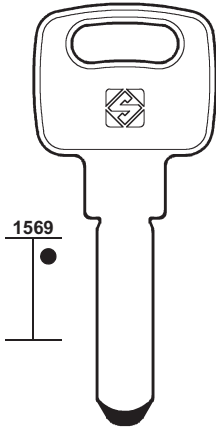

FOR: VACHETTE

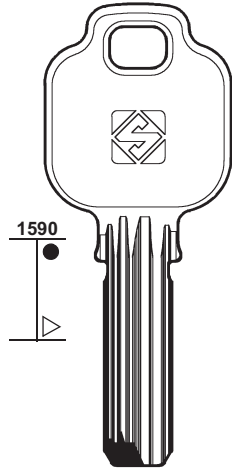

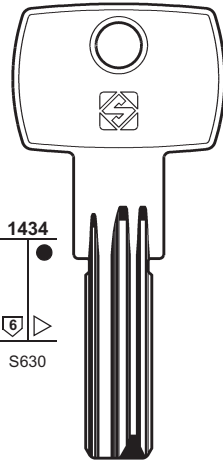
RADIAL

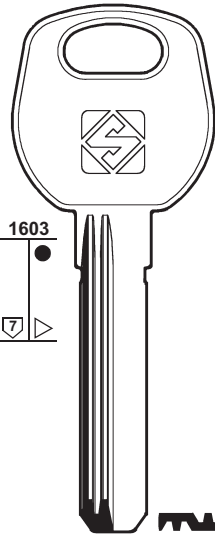
RADIAL

<p>PER: VANGUARD</p> <p>FOR:</p>  <p>1569</p>  <p>VGD1</p>	<p>PER: VBH</p> <p>FOR:</p>  <p>1590</p>  <p>VBH1R</p>	<p>PER: VIRO</p> <p>FOR:</p>  <p>1434</p> <p>6</p> <p>S630</p>  <p>VI19 EURO-PRO</p> <p>FEB</p>	<p>PER: WANJIN</p> <p>FOR:</p>  <p>1603</p> <p>7</p>  <p>WJ1R</p> <p>HOOPLY</p>
--	--	---	---

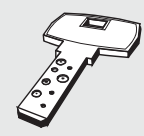

223

PER / FOR

VANGUARD (RA)

VBH (D)
+ FCV (212)

VIDMAR (CH)
 SEA (220)

VIRO (I)
FEB
+ ELCA (210)
+ TESA (221)

WANJIN (PRC)
HOOPLY

WAUS (P)

WILKA (D)

YALE (GB)
+ URBIS (222)









YALE (I)

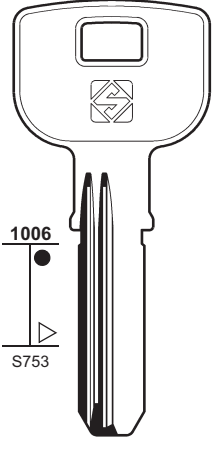

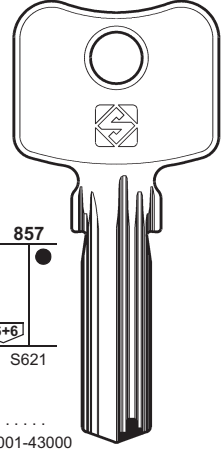

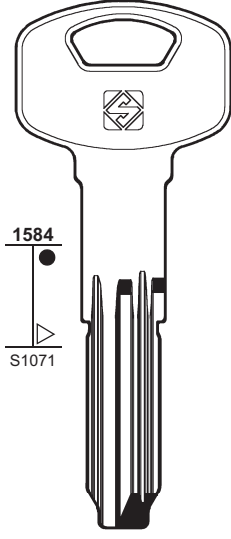

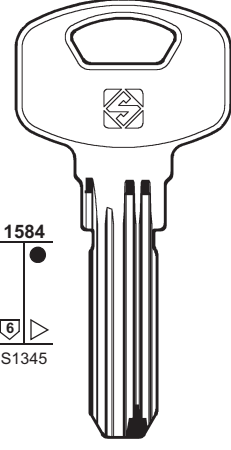

YALTRES (RA)
 FTH (212)

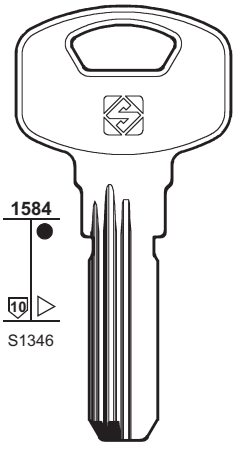
YARDENI (IL)

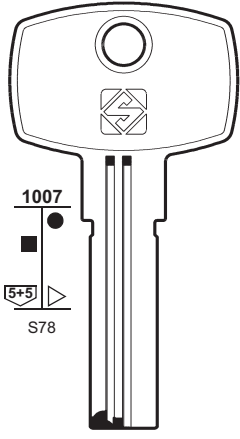
YEMAR (E)
 UCEM (222)

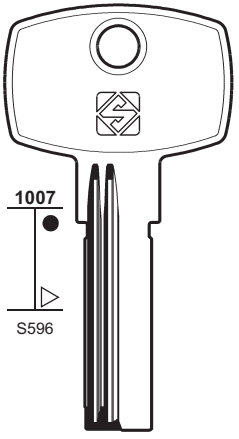
YETI (PL)
 MCM (217)

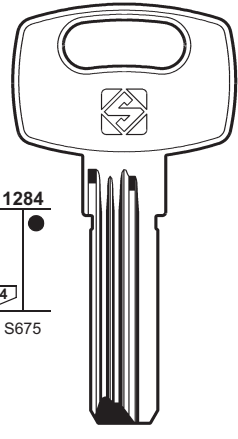
<p>PER: WAUS</p> <p>FOR:</p>  <p>1006</p> <p>S753</p>  <p>WU1R</p>	<p>PER: WILKA</p> <p>FOR:</p>  <p>857</p> <p>6+6</p> <p>S621</p> <p>..... 10001-43000</p>  <p>WK70</p>	<p>PER: YALE (I)</p> <p>FOR:</p>  <p>1584</p> <p>S1071</p>  <p>YA90</p>	<p>PER: YALE (GB)</p> <p>FOR:</p>  <p>1584</p> <p>6</p> <p>S1345</p>  <p>YA94 "1000 Series"</p>
--	---	--	---

<p>PER: YALE (GB)</p> <p>FOR:</p>  <p>1584</p> <p>10</p> <p>S1346</p>  <p>YA95R "2000 Series"</p>	<p>PER: YARDENI</p> <p>FOR:</p>  <p>1007</p> <p>5+5</p> <p>S78</p>  <p>YD6R</p>  <p>1007</p> <p>S596</p>  <p>YD7R</p>  <p>1284</p> <p>4+4</p> <p>S675</p>  <p>YD13R YD14R XL 6</p>		
---	--	--	--

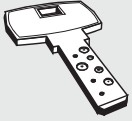

224

PER / FOR

ZADI (I)
BULLOCK

ZHONGHENG (PRC)

PER:
FOR:

ZADI

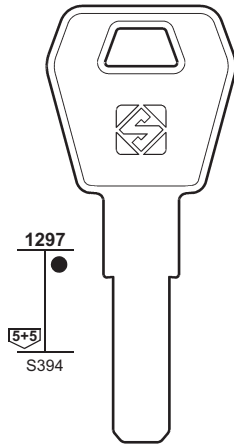

ZD25
BULLOCK

ZHONGHENG

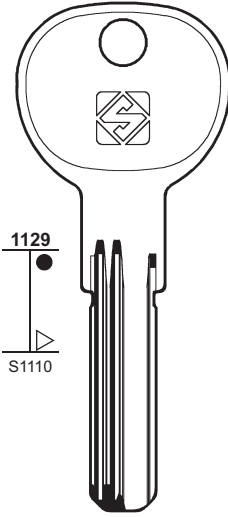

ZH1R

PER:
FOR:

PER:
FOR:



Cruciform Keys
Chiavi a croce
Kreuzschlüssel
Clés cruciformes
Llaves en cruz
Chaves tetra

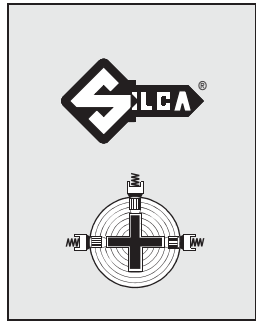
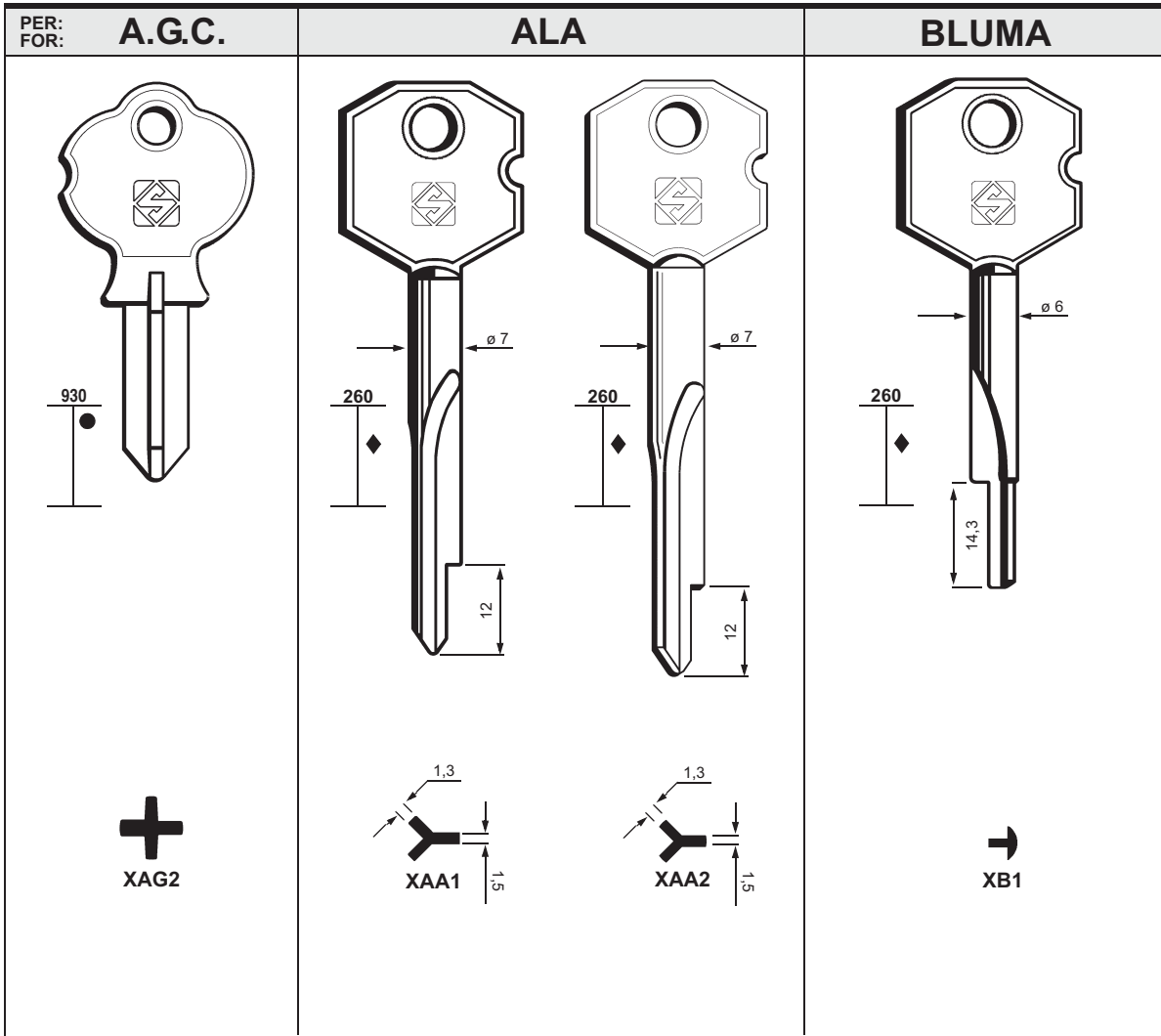

227

PER / FOR
A.G.C. (P)
ALA (I)
BKS (D) YALE (237)
BLUMA (D)
BRASIL (BR)
BRYANSK (RUS)

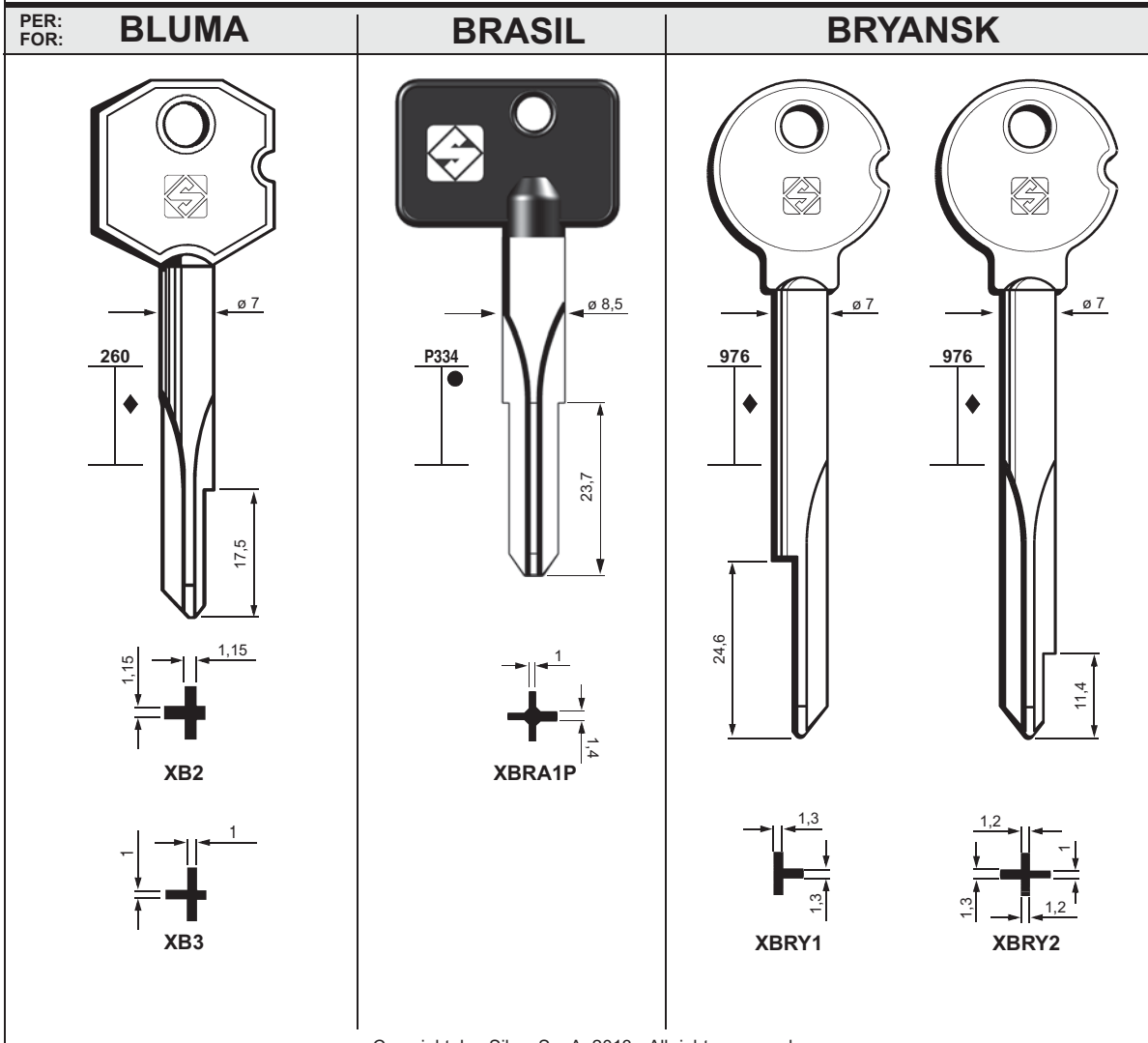

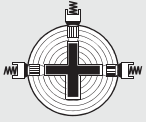

228

PER / FOR

BURG WÄCHTER (D)
FIAM PRÄZIS
TRIOVING

PER:
FOR:

BURG WÄCHTER - Fiam Präzis

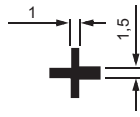
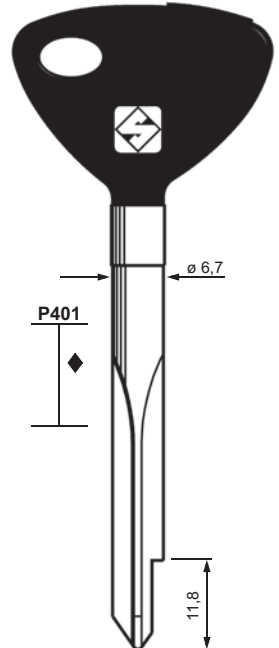
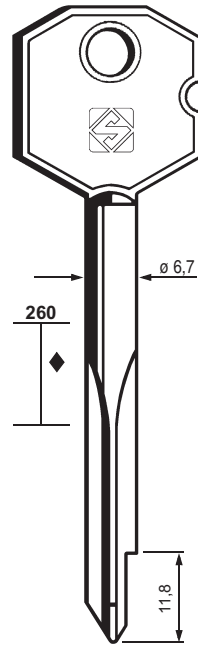
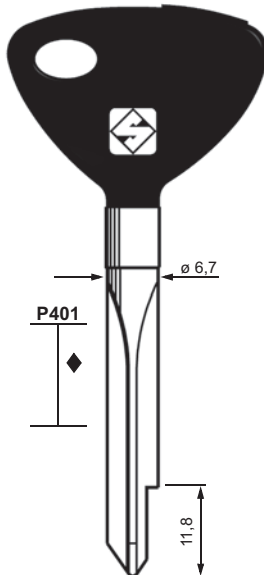
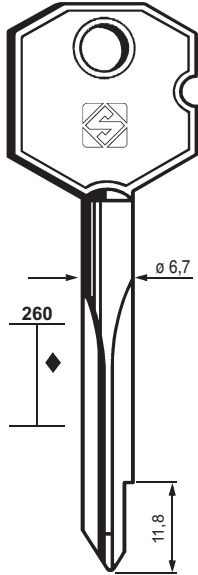

XBW1
mm 75

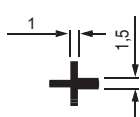

XBW1P
mm 75

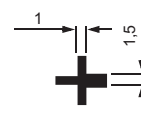

XBW2
mm 85

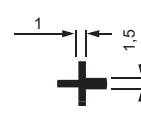

XBW2P
mm 85

TRIOVING

PER:
FOR:

BURG WÄCHTER - Fiam Präzis

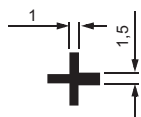
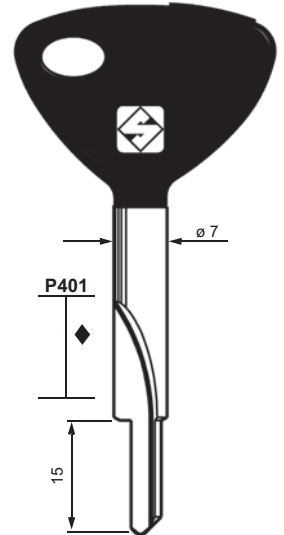
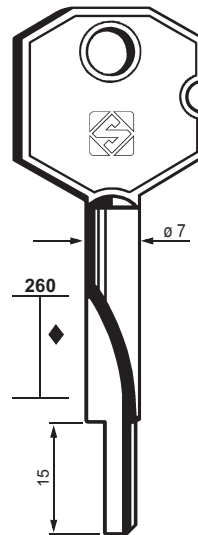
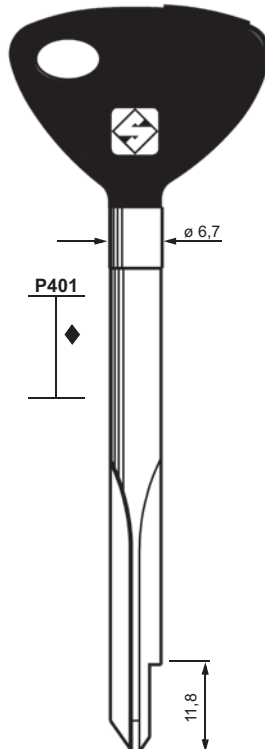
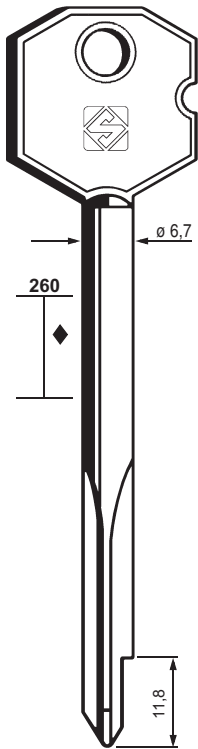

XBW3
mm 100

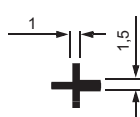

XBW3P
mm 100

XBW4

XBW4P

PER:
FOR:

BURG WÄCHTER - Fiam Präzis

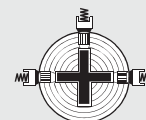

229

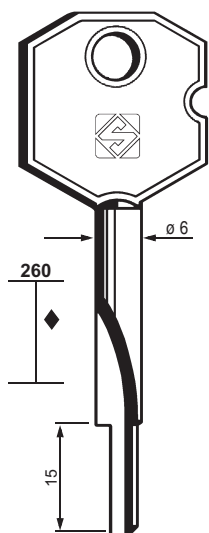

➔
XBW5

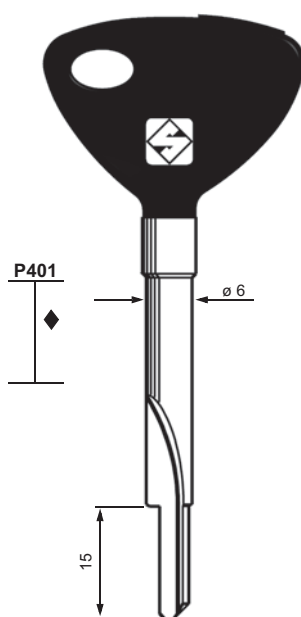

➔
XBW5P

PER / FOR

BURG WÄCHTER (D)
FIAM PRÄZIS

BRICARD (F)

C.R. (I)
YALE (237)

CCF (P)

PER:
FOR:

BRICARD

CCF

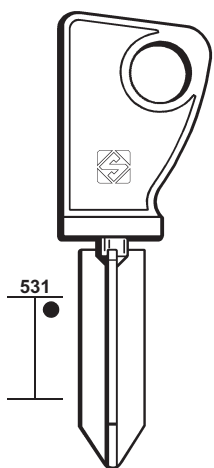

531

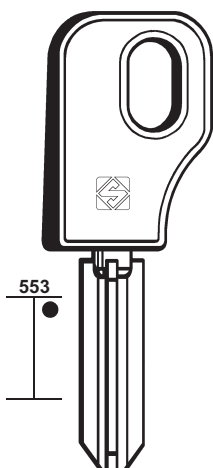

553

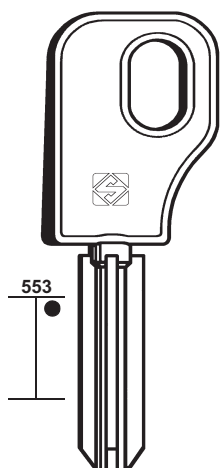

553

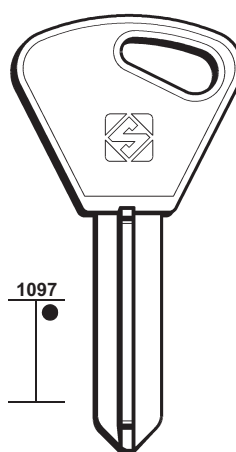

1097

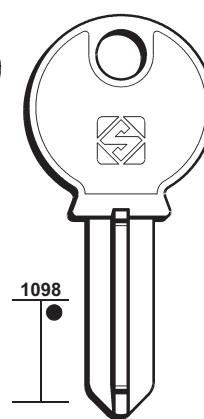

1098



XBD2



XBD3



XBD6



XBD1



XBD7



XBD4



XBD5



XCCF2
CCF5



XCCF3
CCF4

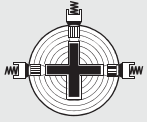

230

PER / FOR

CCF (P)

CRC - CAMBOA (P)

FAB (CZ)

PER:
FOR:

CCF

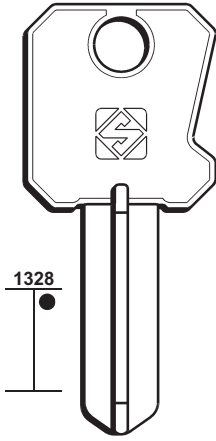

1328

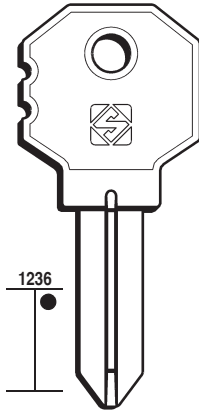

1236

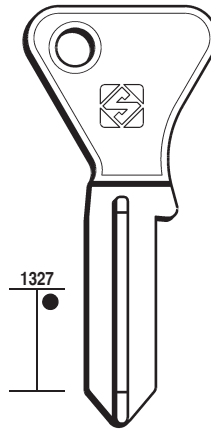

1327

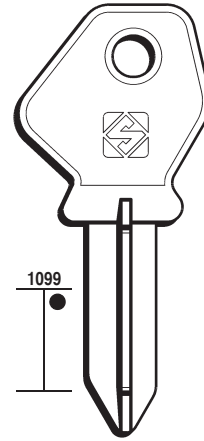

1099

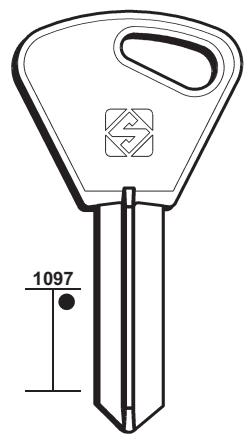

1097



XCCF6
CCF6



XCCF7
CCF7



XCCF8
CCF8



XCCF9
CCF9



XCCF10
CCF10

PER:
FOR:

CRC-CAMBOA

FAB

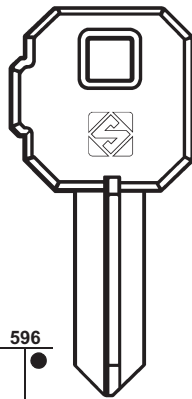

596



XC1

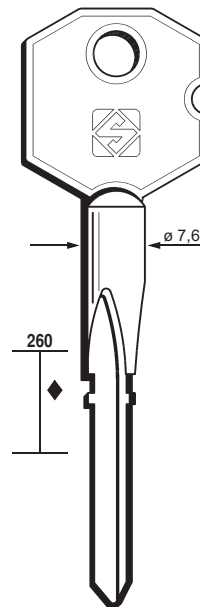

260

ø 7.6

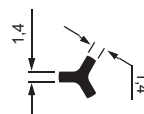

XFB1

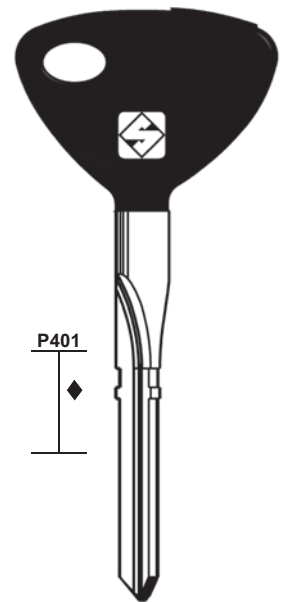

P401

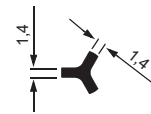

XFB1P

PER:
FOR:

FIAM

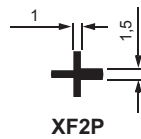
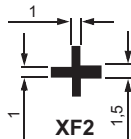
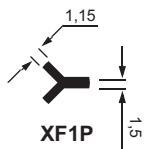
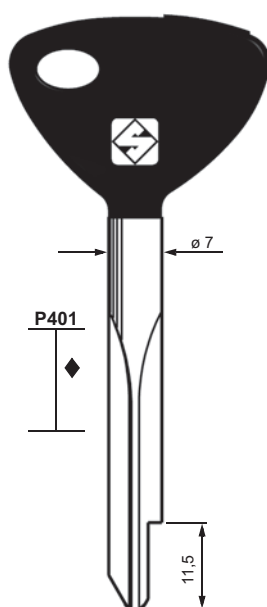
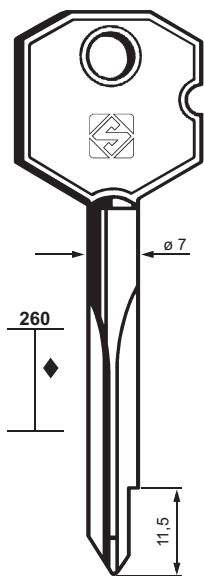
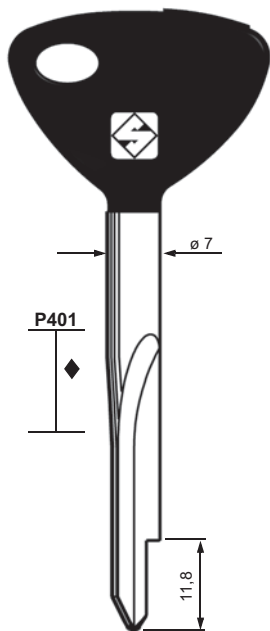

KALE

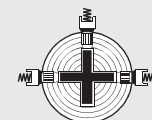

231

PER / FOR

FIAM (I)

KALE

+  YALE (237)

FIAM PRÄZIS (I)

+  BURGWÄCHTER

(228-229)

+  YALE (237)

FRIPA (D)

GERA (D)

G.R. (F)

(GUERVILLE RIQUIER)

PER:
FOR:

FRIPA

G.R.

GERA

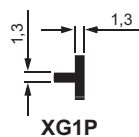
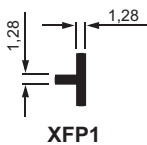
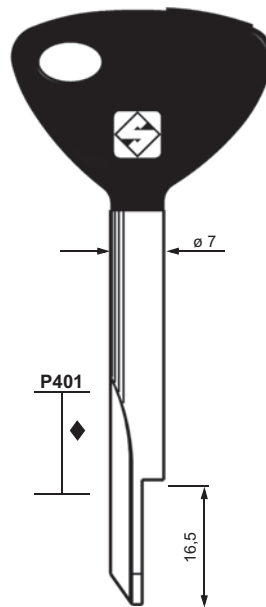
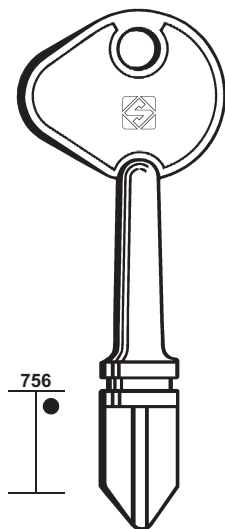
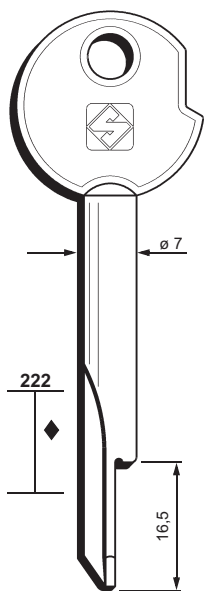

GUERVILLE-RIQUIER

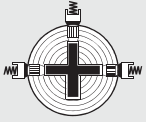

232

PER / FOR

HELCO - KfV (D)

ISEO (I)

KALE (TR)

FIAM (231)

PER:
FOR:

HELCO - KfV

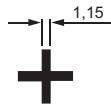
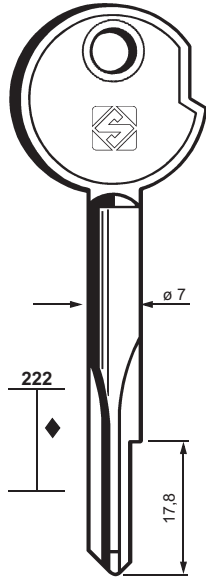

XH1
mm 75

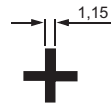
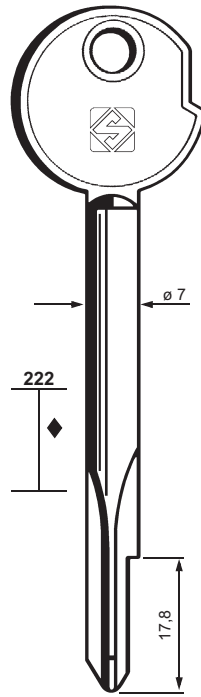

XH2
mm 85

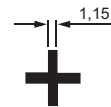
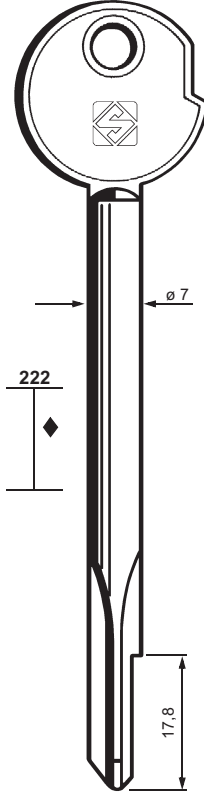

XH3
mm 100

PER:
FOR:

ISEO

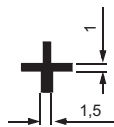
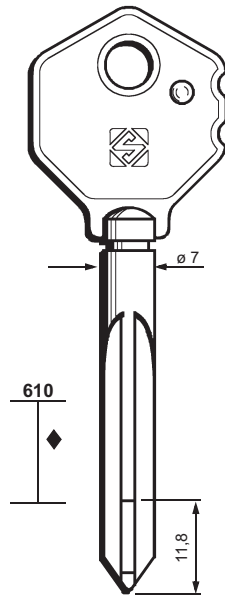

XIE3

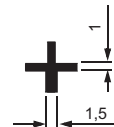
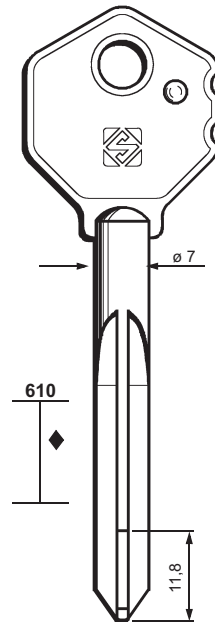

XIE4

PER:
FOR:

KIROV

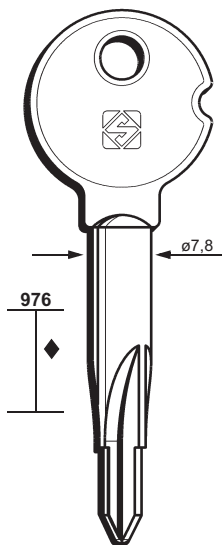

XKV11

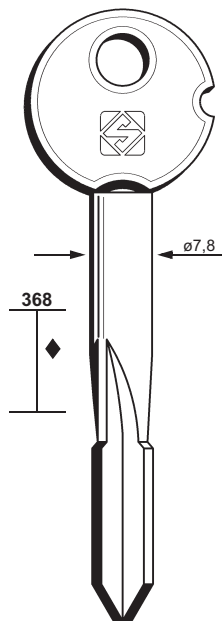
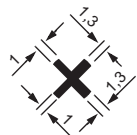

XKV6

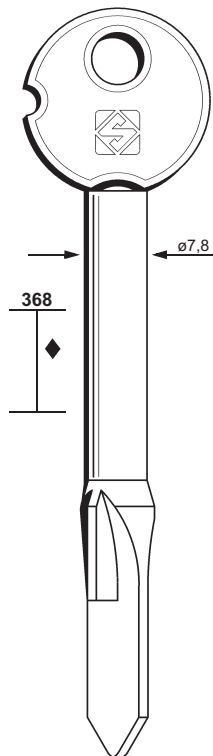

XKV8

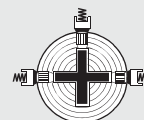
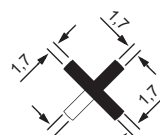

233

PER / FOR

KIROV (RUS)

LIPS (NL)

ZEISS - IKON (240)

PER:
FOR:

KIROV

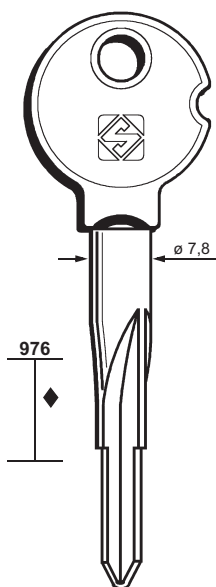

XKV2

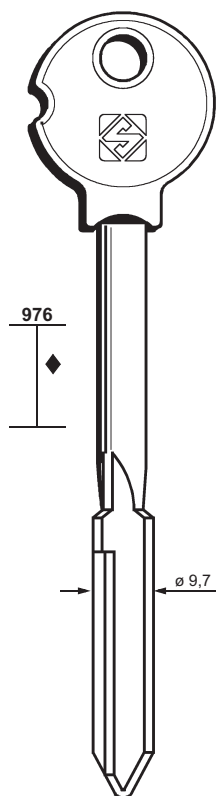
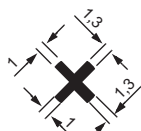

XKV7

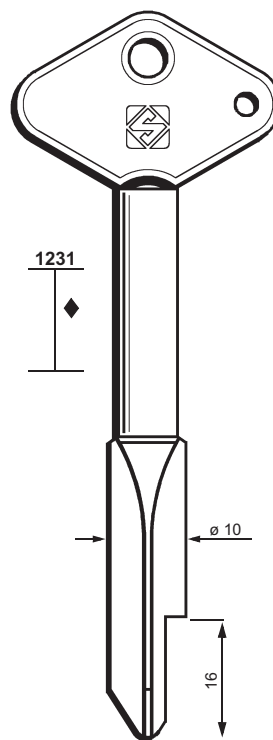

XKV10

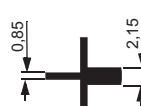

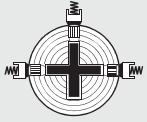

234

PER / FOR

MAFOR (F)
RONIS
SOS

MOBELLA (S)

MOREAUX (F)

NABOB (IL)

PER:
FOR:

MAFOR

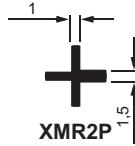
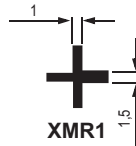
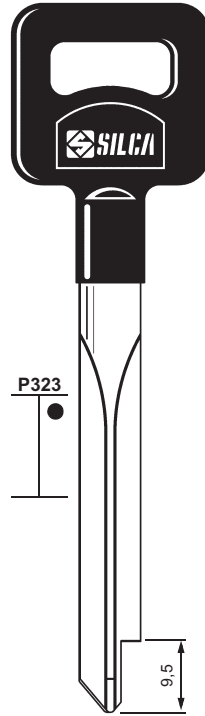
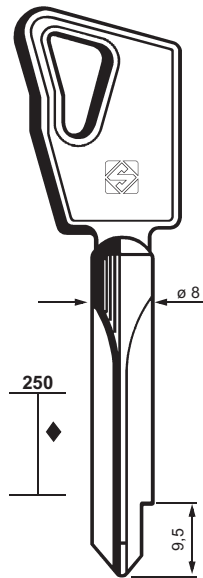

RONIS - SOS

MOBELLA

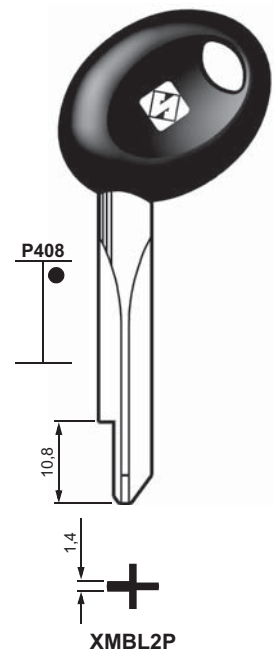

PER:
FOR:

MOREAUX

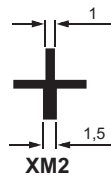
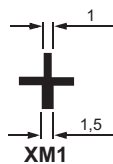
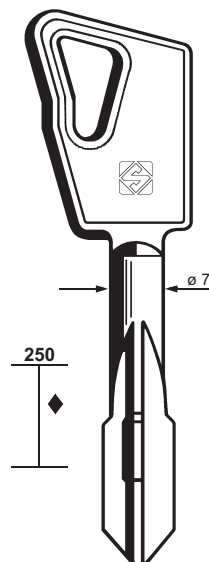
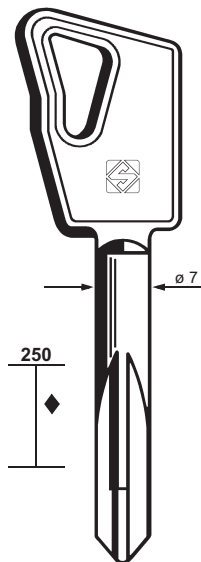

NABOB

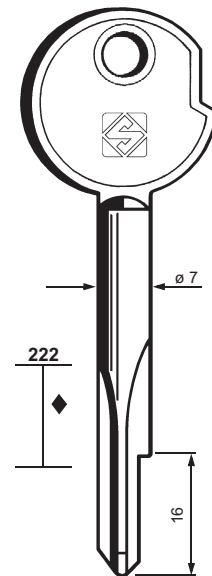

PER:
FOR:

NEMEF

OMEC

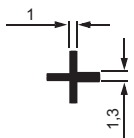
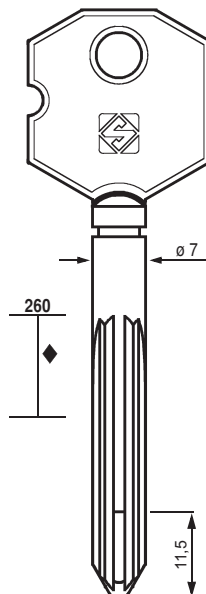
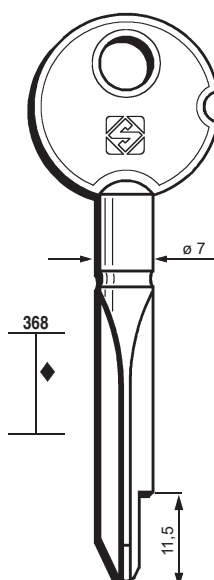
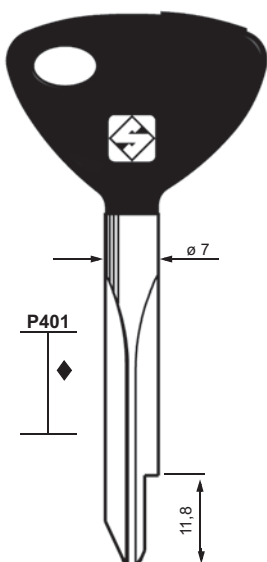
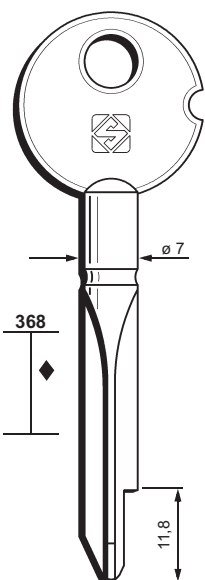

XN1

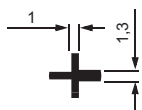

XN1P

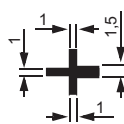

XN3



XOC1

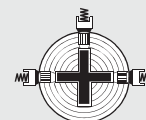

235

PER / FOR

NEMEF (NL)

OMEC (I)

PADO (BR)

PAPAIZ (BR)

PER:
FOR:

PADO

PAPAIZ

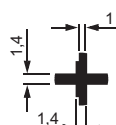
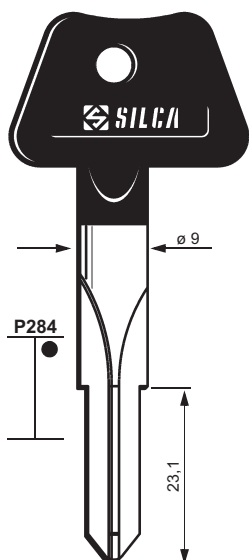

XPDO1P

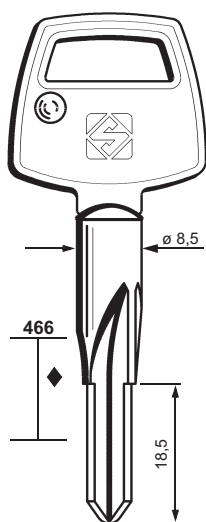

XPZ1

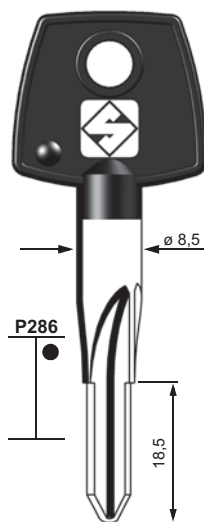

XPZ1P

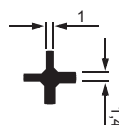
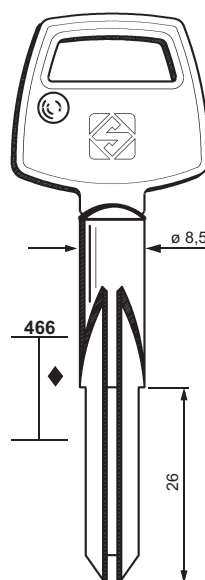

XPZ2

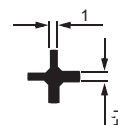
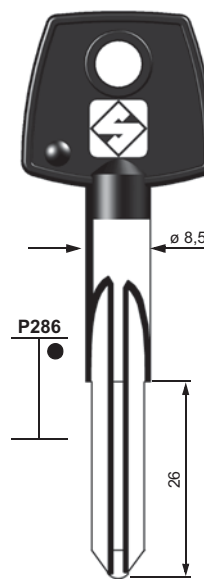

XPZ2P

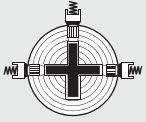

236

PER / FOR

PUNKT (D)

RONIS (F)

MAFOR (234)

SELMACH (RUS)

STAM (BR)

SOS (F)

MAFOR (234)

TRIOVING (S)

BURG WÄCHTER (228)

TUFF (HK)

PER: FOR: PUNKT

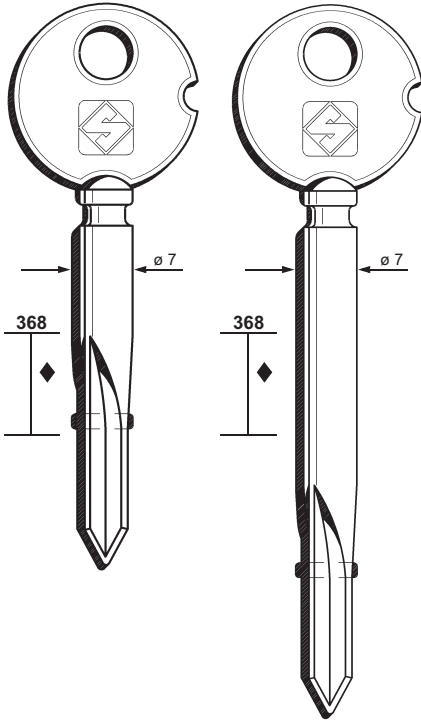

XP1



XP2

PER: FOR: SELMACH

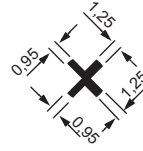
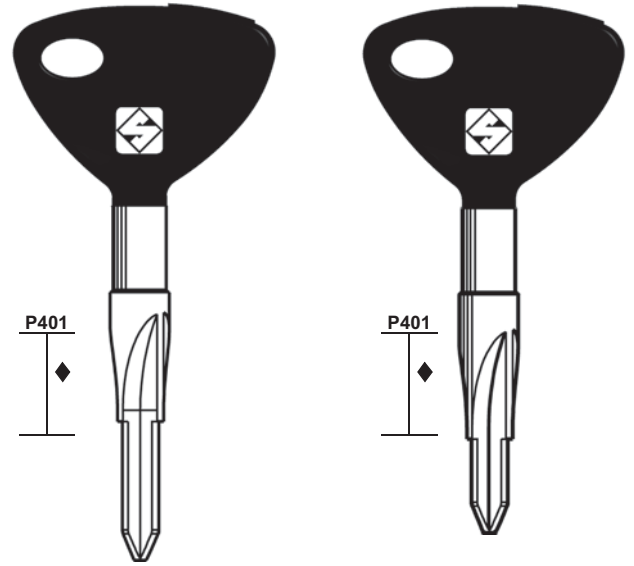

XSLH1P

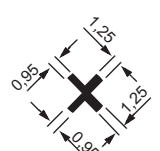

XSLH2P

PER: FOR: STAM

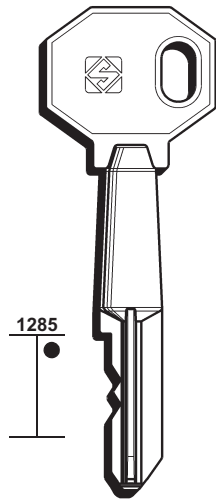

XSAM3

PER: FOR: TUFF

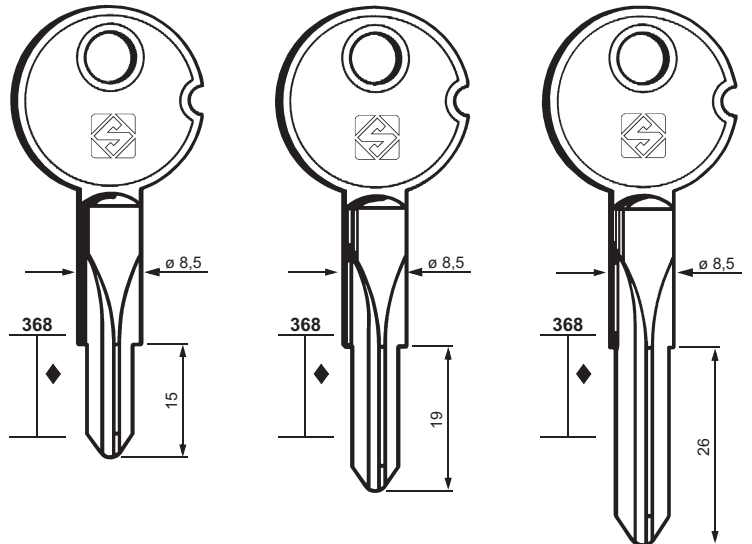

XTF1

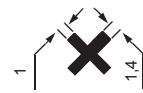

XTF2



XTF3

PER:
FOR:

YALE - BKS

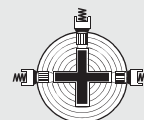

237

PER / FOR

YALE (D)
BKS

YALE (I)
C.R.
FIAM PRÄZIS

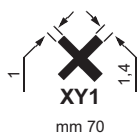
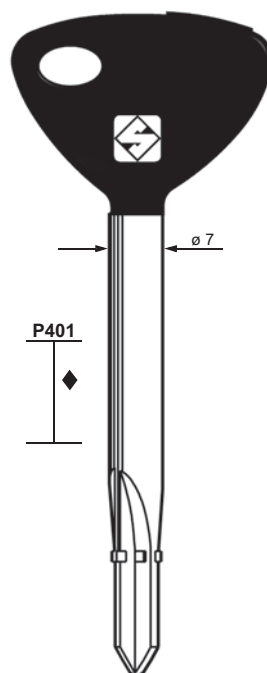
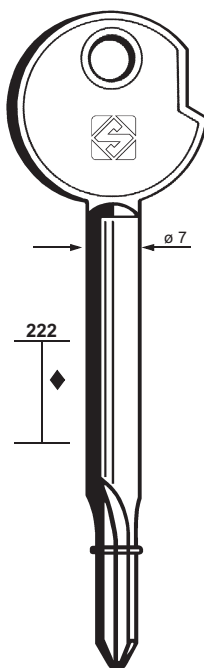
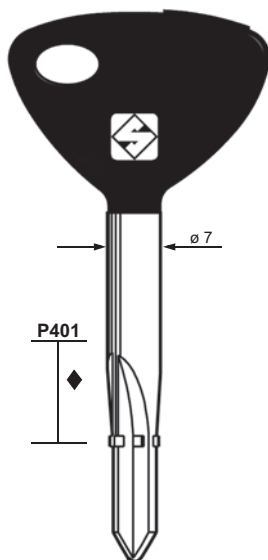
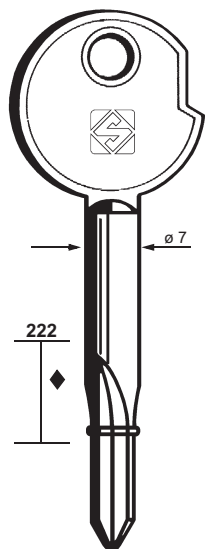

XY1
mm 70



XY1P
mm 70



XY2
mm 85



XY2P
mm 85

BKS

BKS

PER:
FOR:

YALE - BKS

YALE (I)

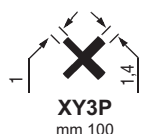
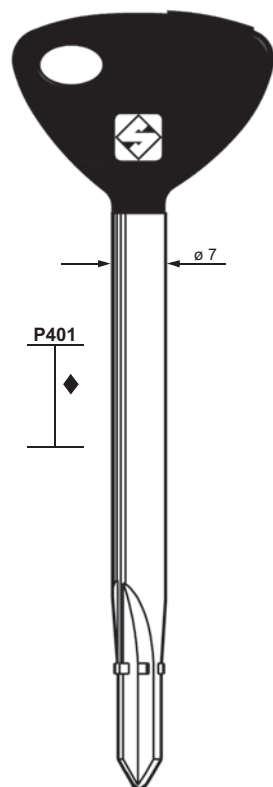

XY3P
mm 100

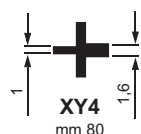
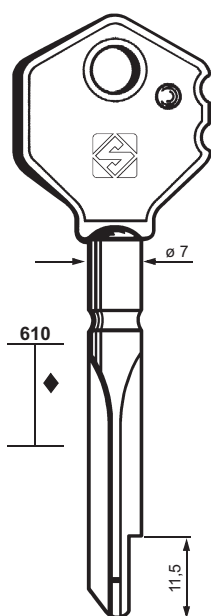

XY4
mm 80

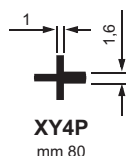
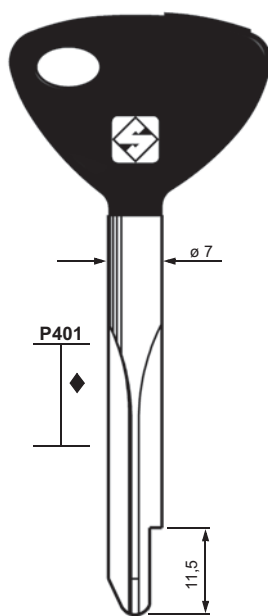

XY4P
mm 80

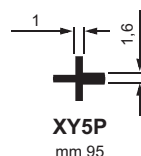
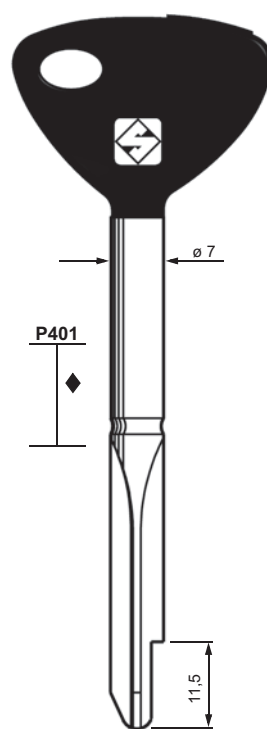

XY5P
mm 95

C.R. - FIAM PRÄZIS

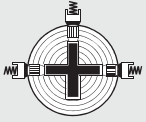

238

PER / FOR

YALE (I)

YALTRES (RA)

ZASO (RC)

PER:

FOR:

YALE (I)

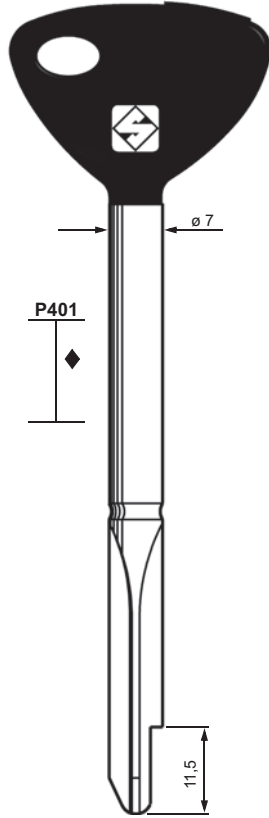

P401

ø 7

11,5

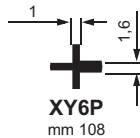

XY6P
mm 108

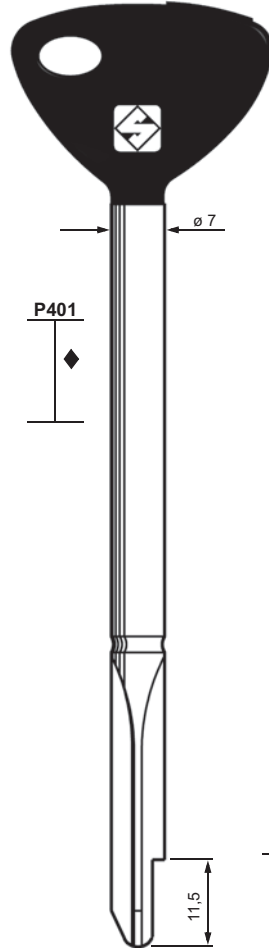

P401

ø 7

11,5

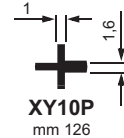

XY10P
mm 126

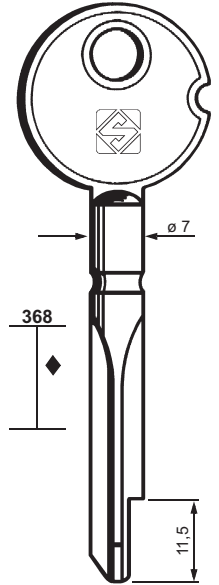

368

ø 7

11,5

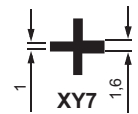

XY7

PER:
FOR:

YALTRES

ZASO

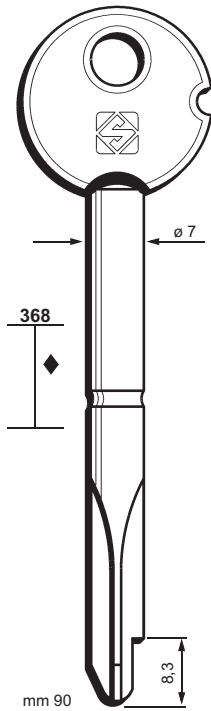

368

ø 7

mm 90

8,3

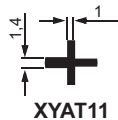

XYAT11

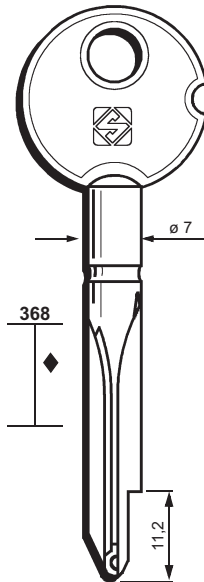

368

ø 7

11,2



XZAS1

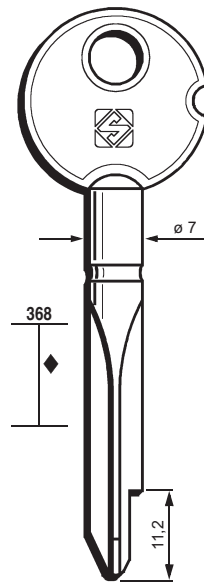

368

ø 7

11,2

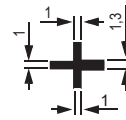

XZAS2

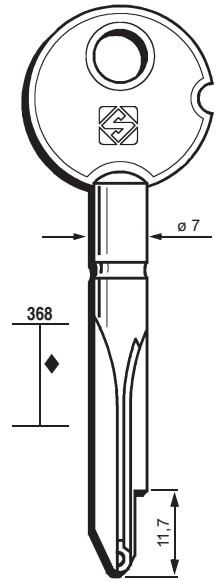

368

ø 7

11,7



XZAS3

PER:
FOR:

ZEISS - IKON

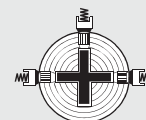

239

PER / FOR

ZEISS - IKON (D)

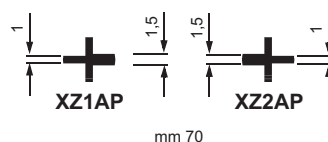
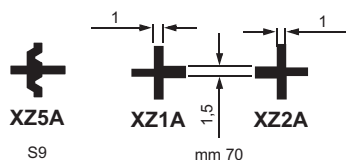
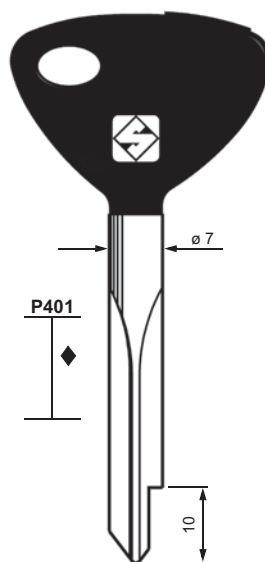
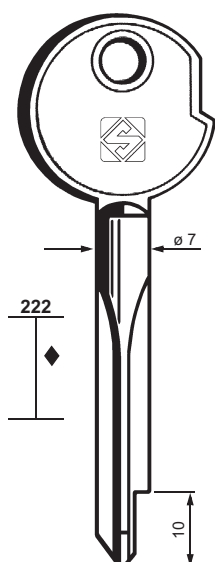

PER:
FOR:

ZEISS - IKON

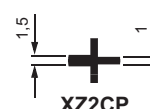
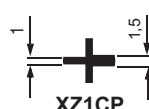
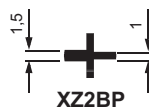
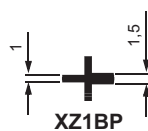
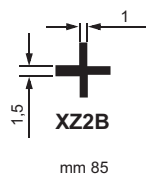
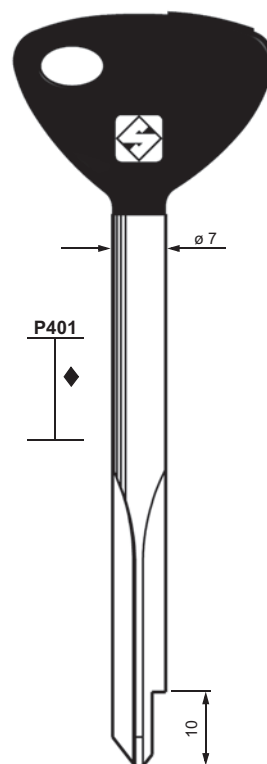
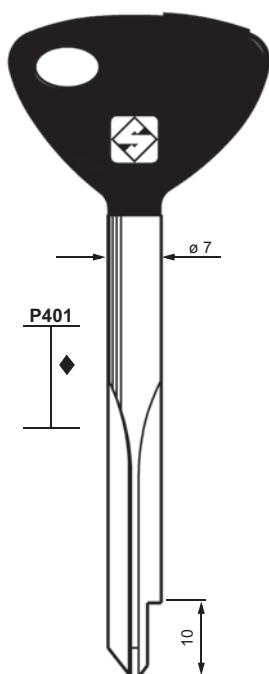
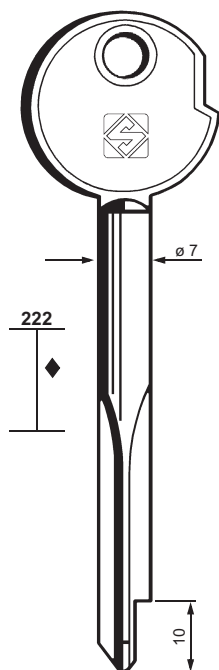

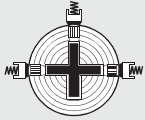

240

PER / FOR

ZEISS - IKON (D)
LIPS

PER:
FOR:

ZEISS - IKON

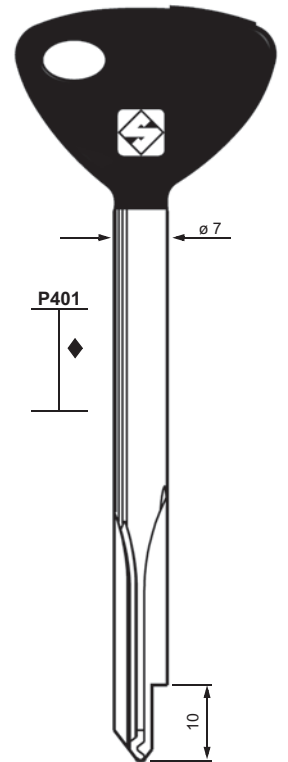
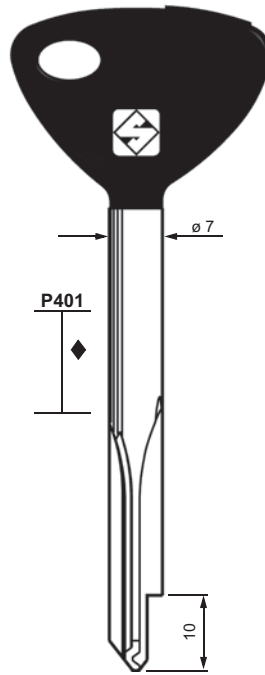
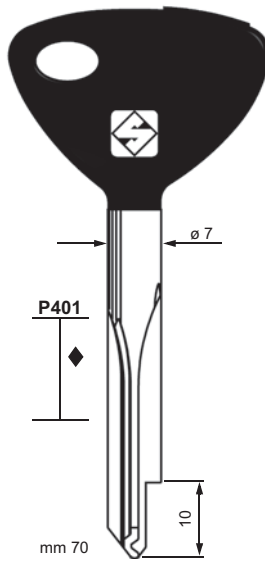
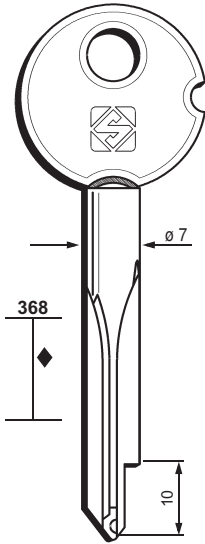

XZ3A
S9
mm 70

LIPS



XZ3AP
S9

LIPS



XZ6AP
VS9



XZ3BP
S9
mm 85



XZ3CP
S9
mm 100

PER:
FOR:



Mail Box and Lift Keys
Chiavi per casellari e ascensori
Fachkästen-und Liftschlüssel
Clés pour casiers et ascenseurs
Llaves para casillas y ascensores
Chaves para caixas de correio e elevadores

PER:
FOR:

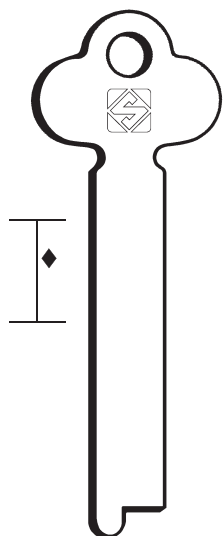

1001

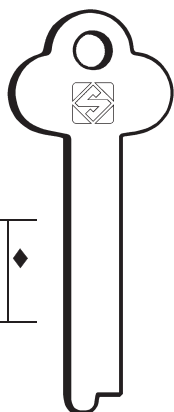

1000

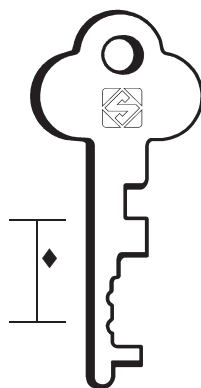

1003P

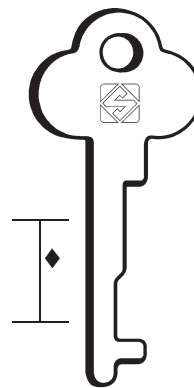

1003P1



243

PER / FOR

CISA (I)

I.B.F.M (I)

J.BEER (GB)
YALE (244)

MILES (RUS)

RIL (P)

SARGENT (USA)

SERRETA (E)

UNION (GB)

PER:
FOR:

CISA

I.B.F.M

MILES

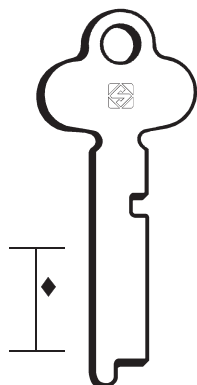

CS1003

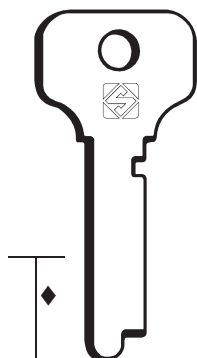

1002

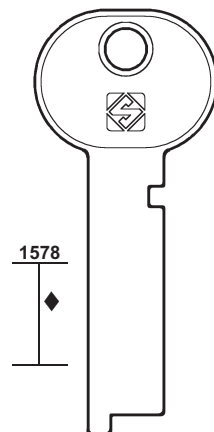

MIS1

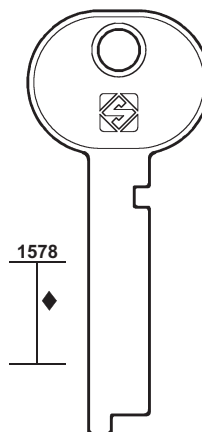

MIS2

PER:
FOR:

RIL

SARGENT

SERRETA

UNION

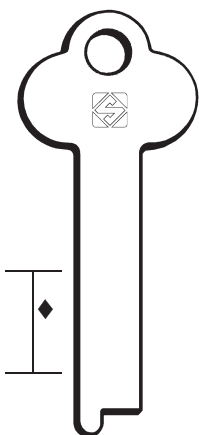

RL1

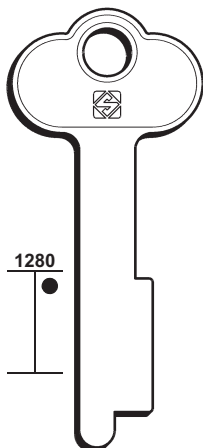

SAR1031

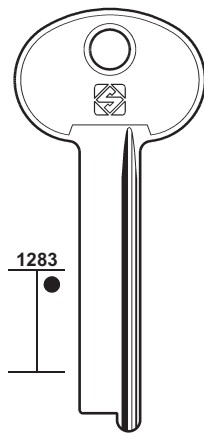

SAR1032

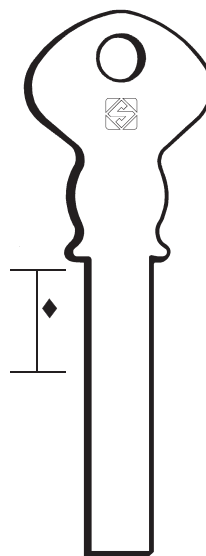

CX7

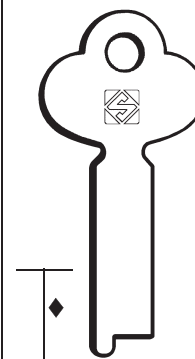

UNI1010



244

PER / FOR

YALE (GB)
J. BEER

CASELLARIO (I)

COUILLET (F)

CUIRASSEE (F)

PER: YALE
FOR:

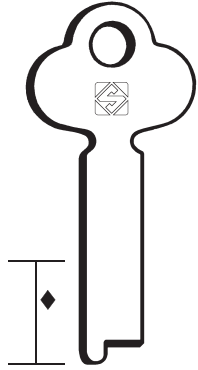

YA1007

J. BEER

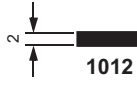
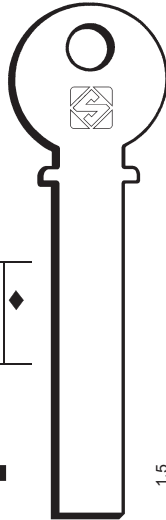

1012



1013

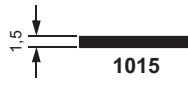

1015



1016 ▲

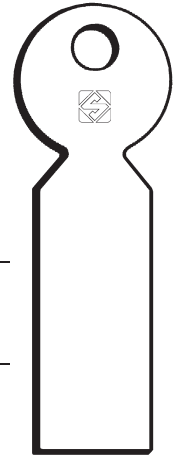

1014

PER: COUILLET
FOR:

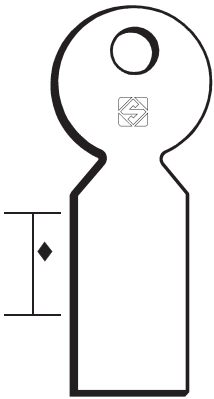

CU402



CU405

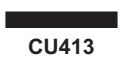

CU413

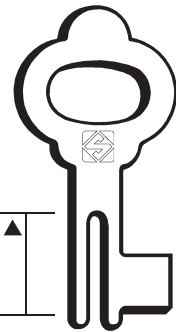

1008

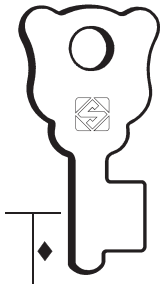

1009

CASELLARIO

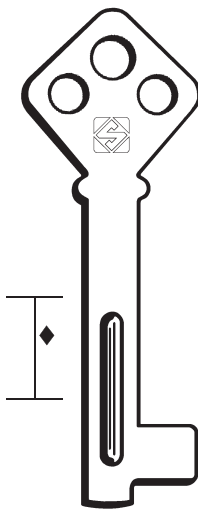

1004
Right/Destro



1005
Left/Sinistro

PER: CUIRASSEE
FOR:

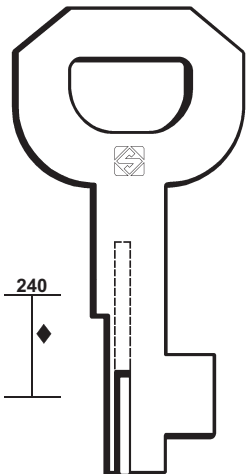

CRE401



CRE402



CRE403

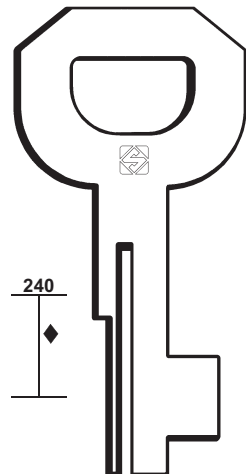

CRE404



CRE405



CRE406

PER:
FOR:

MOBELLAS

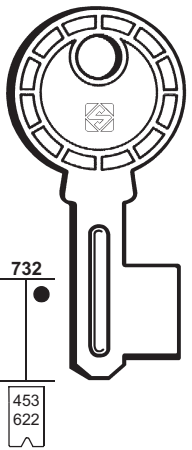

MBS300
 (SER11) 22001-22750
 (SER12) 17501-18250
 (SER13) 16001-16750
 (SER14) 18251-19000
 (SER15) 16751-17500
 (SER21) 11501-12250
 (SER22) 24251-25000
 (SER23) 10751-11500
 (SER24) 12251-13000
 (SER25) 10001-10750
 1-2-3-4-5
 1-2-3-4-5

MBS301
 (SER11) 40751-41500
 (SER12) 36251-37000
 (SER13) 34751-35500
 (SER14) 37001-37750
 (SER15) 35501-36250
 (SER21) 30251-31000
 (SER22) 43001-43750
 (SER23) 29501-30250
 (SER24) 31001-31750
 (SER25) 28751-29500
 1-2-3-4-5
 1-2-3-4-5

PER:
FOR:

MUEL

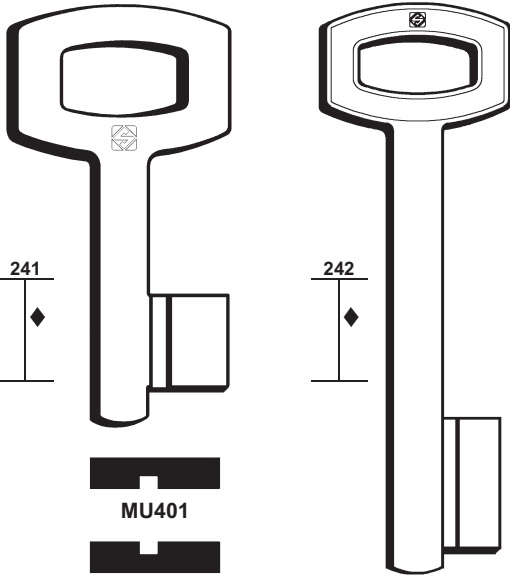

MU401
MU402

MU403
MU404

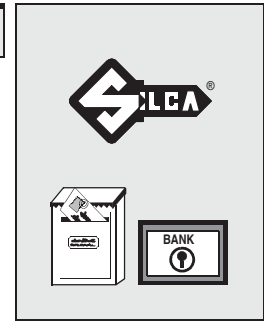

245

PER / FOR
MOBELLAS (S)
MUEL (F)
BODE (D)
HEERUM (D)
KROMA (D) OSTERTAG (245)
OSTERTAG (D) KROMA
STUV (D)

PER:
FOR:

BODE

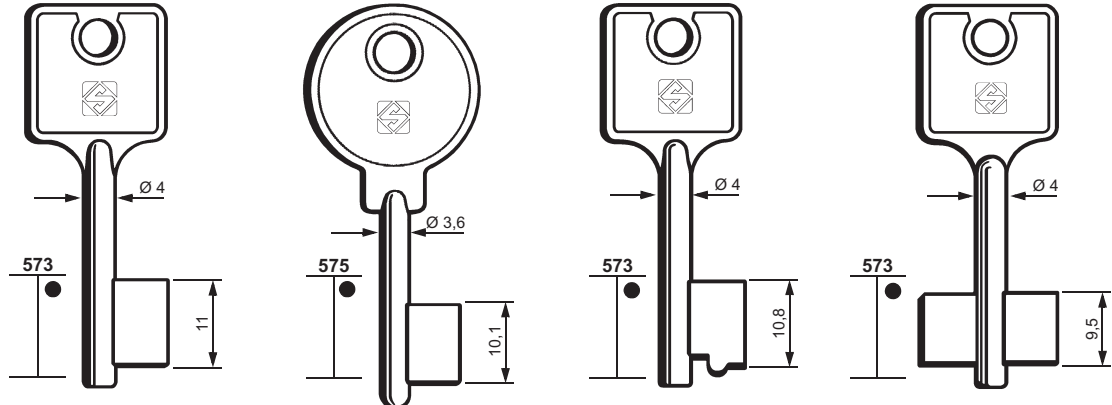

6BDE1 **6BDE2** **6BDE3** **5BDE1**

PER:
FOR:

HEERUM

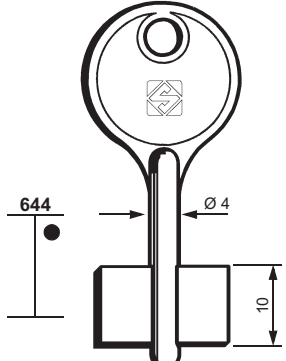

5HRM1

PER:
FOR:

OSTERTAG

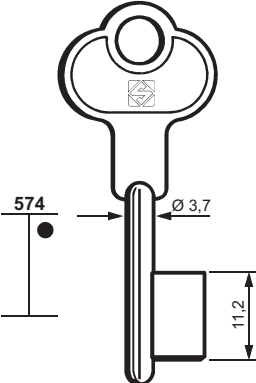

6OG1

KROMA

PER:
FOR:

STUV

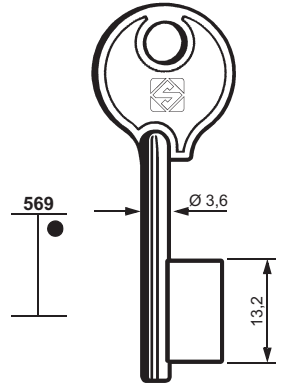

6SV1



246

PER / FOR

BASSETTI (I)

BELLOMO (I)
STIGLER (247)

BONFEDI (I)

BOSISIO (I)

FALCONE (I)

FIAM (I)

INSUBRIA (I)

PER:
FOR:

BASSETTI

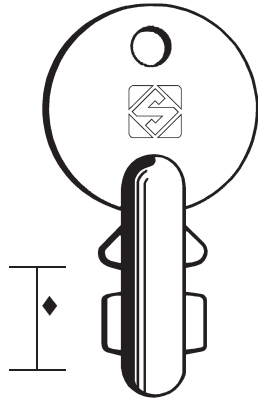

ABA1

BONFEDI

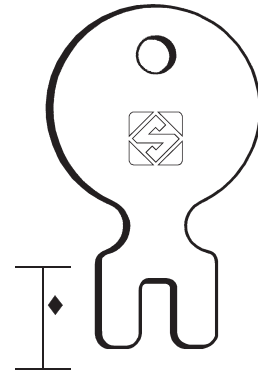

ABO1
Modified/Modificato

PER:
FOR:

BONFEDI

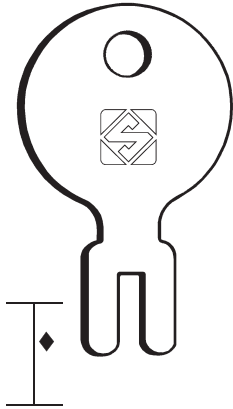

ABO2
Normal/Normale

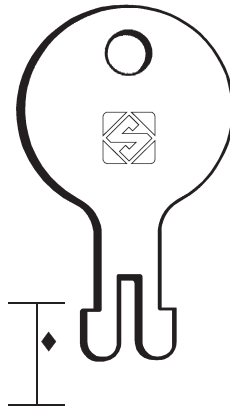

ABO3
To cut out/Ritagliato

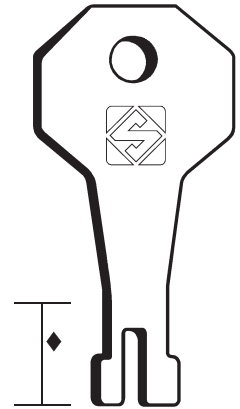

ABO4

PER:
FOR:

BOSISIO

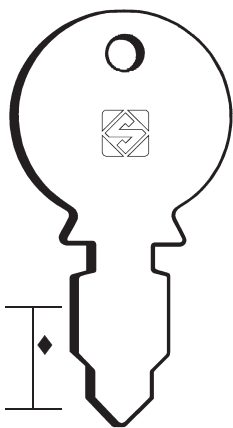

ABOS1

FALCONE

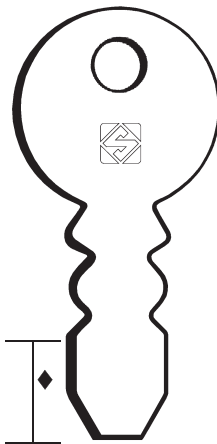

AFA1

FIAM

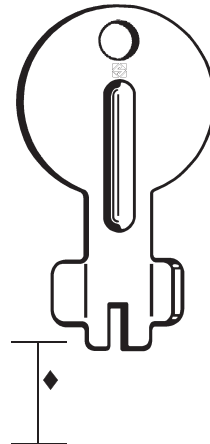





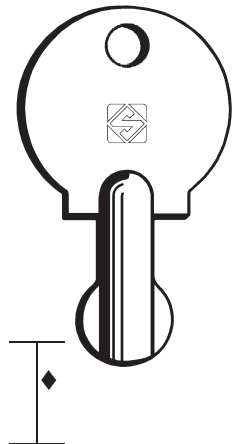

AF1
Universal/Universale

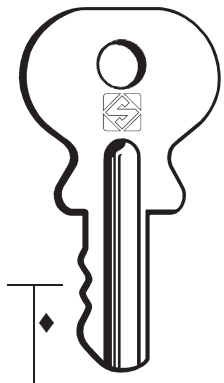
INSUBRIA

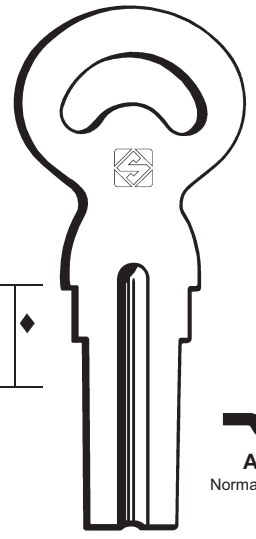

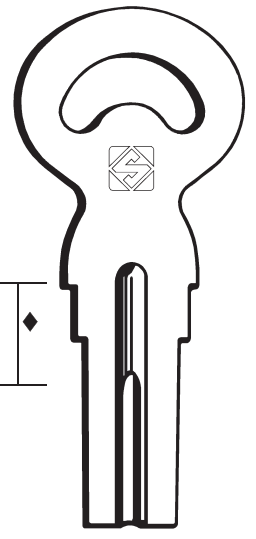



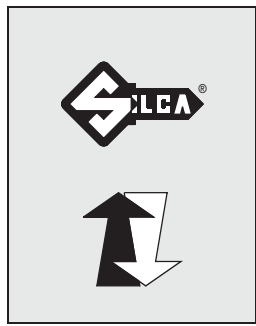

AIN1



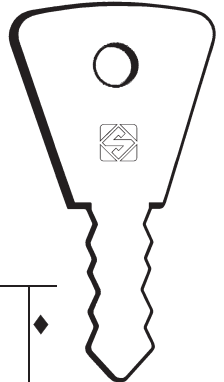

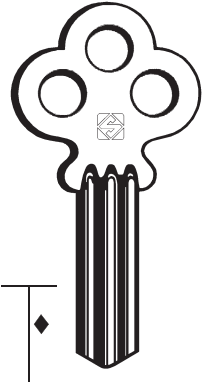
PER: FOR: MANETTI	PERINO	
  AMA1	  APE1 Normal/Normale	  APE2

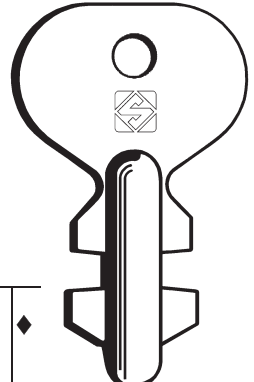

247

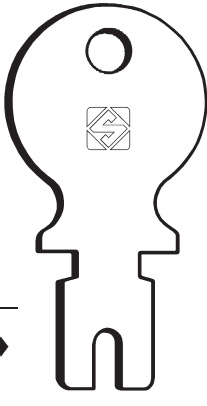
PER / FOR
MANETTI (I)
PERINO (I)
ROMA (I)
SABIEM (I)
SAFOV (I)
S.I.C.E.M. (I)
STIGLER (I) BELLOMO

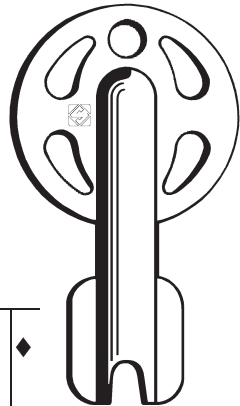
PER: FOR: ROMA	SABIEM	SAFOV
  ARO1	  ASAB1	  ASAF1 Modified/Modificato

PER: FOR: S.I.C.E.M	STIGLER - BELLOMO
  ASI1  ASI2	  AST1



General Index
Indice generale
Generalverzeichnis
Index général
Indice general
Índice geral

Ref.	Page	Ref.	Page	Ref.	Page	Ref.	Page
1		AA2R	13	AB17R	8	AB48	10-205
1000	243	AA3	13	AB18	7	AB50	9
1001	243	AA4	13	AB19	7	AB51	9
1002	243	AA4R	13	AB20	7	AB52	9
1004	244	AA5	13	AB21	6	AB53	9
1005	244	AA5R	13	AB21R	6	AB54	9
1008	244	AA6	13	AB22	6	AB55X	7
1009	244	AA6R	13	AB23	8-91	AB56	9
1012	244	AAA1	4	AB23R	8-91	AB56AP	9
1013	244	AB1	6	AB24	8	AB56R	9
1014	244	AB1R	6	AB25R	6	AB57AP	9
1015	244	AB1RX	7	AB26	6	AB57RAP	9
1016	244	AB1X	7	AB27	8	AB58RAP	9
1003P	243	AB2	7	AB29R	8	AB59RAP	9
1003P1	243	AB2R	7	AB30	8	AB60P	6
4		AB3	7	AB30R	8	AB61	7
454	48	AB3R	7	AB31	8	AB62	10-205
5		AB4	7	AB32	6	AB63	6
5BDE1	245	AB5	7	AB33	6	AB64RAP	9
5HRM1	245	AB6	7	AB34	6	AB65RAP	9
6		AB7	7	AB35	8	AB66R	10
6BDE1	245	AB8	6	AB35R	8	AB67	6
6BDE2	245	AB8R	6	AB36	6	AB68X	7
6BDE3	245	AB9	7	AB36R	6	AB69X	7
6OG1	245	AB10	6	AB37	6	AB70X	7
6SV1	245	AB10R	6	AB37R	6	AB71	9
A		AB11	7	AB38P	6	AB72	7
A303	47	AB11R	7	AB39	8	AB72R	7
AA1	13	AB12	8	AB39R	8	AB74	10-205
AA1R	13	AB12R	8	AB40	10-205	AB75	6
AA2	13	AB13	8	AB41R	8	AB76	9
		AB13R	8	AB42R	6	AB76R	9
		AB14	7	AB43	8	AB77	10-205
		AB14R	7	AB43R	8	AB78R	6
		AB15	8	AB44	6	AB79RX	7
		AB15R	8	AB44R	6	AB81	8
		AB16	8	AB45	8	AB83	7
		AB16R	8	AB46	9	AB84	10-205
		AB17	8	AB47R	6	AB85	9

Ref.	Page	Ref.	Page	Ref.	Page	Ref.	Page
AB86	7	AG7	12	AGN1	12-206	ALP10	14
AB90R	9	AG7R	12	AH1	16	ALP11	14
AB91	10	AG8	12	AHR2	13-206	ALP12	15
AB93R	9	AG8R	12	AI1	14	ALP14R	15
ABA1	246	AG9	12	AI2	14	ALP16	15-206
ABB1	246	AG9R	12	AIN1	246	ALU1	15
ABO1	246	AG10	12	AKR1	16	AMA1	247
ABO2	246	AGA1	10	AKR2	16	AMC1R	15
ABO3	246	AGA1R	10	AKR3	16	AMC2R	15
ABO4	246	AGA2	10	AKR3R	16	AMC3	15
ABOS1	246	AGA2R	10	AKR4	16	AMG1R	16-206
AC1	4	AGA3	10	AKR5	16	AN1	17
AC2	4	AGA4	10	AKR6	16	AN1R	17
ACR1	16	AGA4R	10	AKR7	16	APA1R	18
ACR3	16	AGA5	10	AKR8	16	APA2R	18
ACR4	16	AGA5R	10	AKR9R	17	APE1	247
AD1	10	AGA6	11	AKR10	16	APE1F	247
AD2	10	AGA7	11-205	AKR11R	17	APE2	247
ADT1	10	AGA8	11	AKR14	17	APK1	17
AE1R	13	AGA9	11-205	AKR15	16	APK2R	17-206
AE2R	13	AGA25	10	AL1	13	APK3R	17-206
AEP1	10	AGA25R	10	AL1R	13	AQ1	17
AEP2	10	AGB1	11	ALA1R	14	AQ1R	17
AF4C	102	AGB1R	11	ALA2R	14	AQ3	17
AF4D	102	AGB2	11	ALK1	14	AQ3R	17
AFA1	246	AGB2R	11	ALK2	14	AQ4	17
AFI1	246	AGB3	11	ALM1	15	AQ4R	17
AG1	12	AGB3R	11	ALM1R	15	ARE1	17
AG1R	12	AGB4	11	ALP1	14	ARF1	17
AG2	12	AGB5	11-205	ALP2	14	ARL1	17
AG2R	12	AGB6	11-205	ALP3	14	ARL1R	17
AG3	12	AGB7	11-205	ALP4	15	ARO1	247
AG3R	12	AGB8	11-205	ALP4R	15	ARS1	18
AG4	12	AGB9	11-205	ALP5R	15	ARS2	18
AG4R	12	AGE1	12	ALP6R	15	ART1	17
AG5	12	AGE1R	12	ALP7R	15	ART1R	17
AG5R	12	AGE2	12	ALP8R	15	AS1	18-47
AG6	12	AGE3	12	ALP9	15	ASAB1	247
AG6R	12	AGE5R	12	ALP9R	15	ASAF1	247

Ref.	Page	Ref.	Page	Ref.	Page	Ref.	Page
ASEC1	13	ASS20	22	ASS39R	22	ASS77R	21
ASEC2	14	ASS20R	22	ASS40	21	ASS78	21
ASI1	247	ASS21	20	ASS40R	21	ASS78R	21
ASI2	247	ASS21R	20	ASS42	21	ASS79	21
ASN1	18	ASS22	22	ASS42R	21	ASS79R	21
ASS2	19	ASS22R	22	ASS44	20	ASS80	22
ASS2R	19	ASS23	20	ASS44R	20	ASS80R	22
ASS3	21	ASS23R	20	ASS45	22	ASS81	22
ASS3R	21	ASS24	22	ASS45R	22	ASS81R	22
ASS4	22	ASS24R	22	ASS47	19	ASS82	22
ASS4R	22	ASS25	20	ASS48R	22	ASS82R	22
ASS6	18-165	ASS25R	20	ASS50	23	ASS84	23
ASS6R	18-165	ASS26	22	ASS50R	23	ASS84R	23
ASS7	20	ASS26R	22	ASS51	23	ASS85	23
ASS7R	20	ASS27	20	ASS51R	23	ASS85R	23
ASS8	22	ASS27R	20	ASS52	23	ASS86	23
ASS8R	22	ASS28	22	ASS52R	23	ASS86R	23
ASS9	19	ASS28R	22	ASS53	21	ASS87	23
ASS9R	19	ASS29	20	ASS53R	21	ASS87R	23
ASS10	19	ASS29R	20	ASS55	23	ASS88	23
ASS10R	19	ASS30	22	ASS55R	23	ASS88R	23
ASS11	19	ASS30R	22	ASS56	23	ASS90	22
ASS11R	19	ASS31	19	ASS56R	23	ASS90R	22
ASS12	21	ASS31R	19	ASS63	18	ASS91	23
ASS12R	21	ASS32	21	ASS64	20	ASS91R	23
ASS13	20	ASS32R	21	ASS64R	20	ASS92	23
ASS13R	20	ASS33	19	ASS65	20	ASS92R	23
ASS14	22	ASS33R	19	ASS65R	20	ASS93	23
ASS14R	22	ASS34	22	ASS66	20	ASS93R	23
ASS15	20	ASS34R	22	ASS66R	20	ASS94	23
ASS15R	20	ASS35	20	ASS67	20	ASS94R	23
ASS16	22	ASS35R	20	ASS67R	20	ASS102	23
ASS16R	22	ASS36	22	ASS68R	20	ASS102R	23
ASS17	20	ASS36R	22	ASS69	20	ASS103	23
ASS17R	20	ASS37	20	ASS69R	20	ASS103R	23
ASS18	22	ASS37R	20	ASS73	21	ASS104	23
ASS18R	22	ASS38	21	ASS73R	21	ASS104R	23
ASS19	20	ASS38R	21	ASS76R	21	ASS105	23
ASS19R	20	ASS39	22	ASS77	21	ASS105R	23

Ref.	Page	Ref.	Page	Ref.	Page	Ref.	Page	
ASS106R	23	ASS130R	21	ASS180R	20	AY13	5	
ASS107	22	ASS131	21	ASS181	19	AY14	5	
ASS107R	22	ASS131R	21	ASS183	23	AY15	5	
ASS108	22	ASS132	23	ASS183R	23	AY16	4	
ASS109	22	ASS132R	23	ASS186	18	AY17	5	
ASS110	21	ASS133	23	AST1	247	AY18	5	
ASS110R	21	ASS133R	23	ASU1R	12	AY20	5	
ASS112	21	ASS134	21	ASU2	12	AY21	5	
ASS112R	21	ASS134R	21	AT1	23	AY23	5	
ASS113	21	ASS135	21	AT1R	23	AY24	5	
ASS113R	21	ASS136	21	ATA1	23	AY25	5	
ASS115	21	ASS136R	21	ATA1R	23	AY26	5	
ASS115R	21	ASS137	19	AUC1	17	AY27	5	
ASS116	21	ASS138	21	AUC4	18	AY28	6	
ASS116R	21	ASS138R	21	AUC5	18	AY29	6	
ASS118	21	ASS139R	21	AUC6	18	AY30	4	
ASS118R	21	ASS140R	21	AUN1	23	AY31	5	
ASS119	21	ASS141	21	AUS1	24	AZ1	24	
ASS119R	21	ASS142	19	AV1	24	AZ1R	24	
ASS120	20	ASS143	19	AV1R	24	AZ2	24	
ASS120R	20	ASS144	19	AV2	24	AZ2R	24	
ASS121	20	ASS145	19	AVC1	24	AZ3	24	
ASS121R	20	ASS146	19	AW1	18	AZ3R	24	
ASS122R	19	ASS147	19	AW2	18	AZ4	24	
ASS123	23	ASS148	19	AW3	18	AZ5	24	
ASS123R	23	ASS149	19	AW4	18	AZ6	24-206	
ASS124	20	ASS150	19	AW5	18	AZ6R	24-206	
ASS124R	20	ASS151	19	AW6	18	AZ7	25-206	
ASS125	22	ASS152	19	AW7	18	AZ8	25-206	
ASS125R	22	ASS153	19	AX2	24	AZ9	25	
ASS126	21	ASS154	19	AY1	4	AZ9R	25	
ASS126R	21	ASS155	19	AY1P	4	AZ10	25	
ASS127	21	ASS155R	19	AY2	5	AZ10R	25	
ASS127R	21	ASS172	19	AY2P	5	<h1>B</h1>		
ASS128	21	ASS174	19	AY3	5			
ASS128R	21	ASS175R	19	AY3P	5			
ASS129	23	ASS176	19	AY10P	6			
ASS129R	23	ASS177	19	AY11	4			
ASS130	21	ASS178	19	AY12	4			
							BA1	28
							BA5	28
							BA5R	28
						BA8	28	

Ref.	Page	Ref.	Page	Ref.	Page	Ref.	Page
BA8R	28	BAB30R-1	27	BD1	35	BES3	29
BAB2R	25	BAB30R-2	27	BD2	35	BES4	29
BAB4R	25	BAB30R-3	27	BD2R	35	BES5	29
BAB5R	25	BAB30R-4	27	BD3	35	BES6	29
BAB6R	25	BAB30R-5	27	BD3R	35	BES7	29
BAB7R	25	BAB30R-6	27	BD4	35	BES8	29
BAB13	26	BAB30R-7	27	BD4R	35	BES9	29
BAB13R	26	BAB30R-8	27	BD5	35	BES10	29
BAB14	26	BAB30R-9	27	BD6	35	BES11	29
BAB15	26	BAB30R-10	27	BD6R	35	BES12	29
BAB16	26	BAB30R-11	27	BD7	35	BES18	29
BAB18R	25	BAB31	27	BD8	35	BEY1R	29-206
BAB19	26	BAD1	27	BD8R	35	BEY2R	29-206
BAB20	26	BAD1R	27	BD9R	35	BG1	30
BAB21-3	26	BAE1	27-206	BD10	35	BHF1T	32
BAB21-4	26	BAI1	28	BD10R	35	BI062	30
BAB21-5	26	BAI2	27	BD11	35-207	BI063	30
BAB25	26	BAI3	27	BD11X	35-207	BI110	30
BAB25R	26	BAI4R	27	BD13	35-207	BIL1T	30
BAB26R-1	26	BAI5R	27	BD14	35-207	BK1	30
BAB26R-2	26	BAI7	28	BD14X	35-207	BK1R	30
BAB26R-3	26	BAI23	28	BD16	35-207	BK1X	30
BAB26R-4	26	BAL1	25	BD17	35	BK2R	30
BAB26R-5	26	BAL1R	25	BD21	35-207	BK3-1	30
BAB26R-6	26	BAL2	25	BD22	35-207	BK3-2	30
BAB26R-7	26	BAL3	25	BD100	35	BK3-3	30
BAB26R-8	26	BAL4	25	BD101	35	BK3-4	30
BAB26R-9	26	BAL5	25	BD102	35	BK3-5	30
BAB26R-10	26	BAL6	25	BDA10	32	BK3-6	30
BAB26R-11	26	BAL7	25	BE1	29	BK3-7	30
BAB26R-12	26	BAR1	27	BE1R	29	BK3-8	30
BAB26R-13	26	BAR1R	27	BE3	29	BK3-9	30
BAB26R-14	26	BAS1	28	BE4R	29	BK3-10	30
BAB26R-15	26	BAS4R	28	BE200	29	BK3-11	30
BAB26R-16	26	BAS5R	28	BE201	29	BK3-12	30
BAB26R-17	26	BAT1P	28	BE202	29	BK4	31
BAB27	26	BAT2	29	BE203	29	BK4R	31
BAB28R	26	BC1	27	BES1	29	BK5-1	31
BAB29	26	BC1R	27	BES2	29	BK5-2	31

Ref.	Page	Ref.	Page	Ref.	Page	Ref.	Page
BK5-3	31	BK6-7	31	BK8	31	BK28	30
BK5-4	31	BK6-8	31	BK8R	31	BK29	30
BK5-5	31	BK6-9	31	BK10-00	32	BK30	30
BK5-6	31	BK6-10	31	BK10-01	32	BK31	30
BK5-7	31	BK6-11	31	BK10-02	32	BK32	30
BK5-8	31	BK6-12	31	BK10-03	32	BK34	30
BK5-9	31	BK6-13	31	BK10-04	32	BK36	30
BK5-10	31	BK6-14	31	BK10-05	32	BK37	30
BK5-11	31	BK6-15	31	BK10-06	32	BK38	30
BK5-12	31	BK6-16	31	BK10-07	32	BL1	32
BK5-13	31	BK6-17	31	BK10-08	32	BL1R	32
BK5-14	31	BK6-18	31	BK10-09	32	BLA1	32
BK5-15	31	BK6-19	31	BK10-10	32	BLA2	32
BK5-16	31	BK6-20	31	BK10-11	32	BLA3	32
BK5-17	31	BK6-21	31	BK10-12	32	BLG1	36
BK5-18	31	BK6-22	31	BK10-13	32	BLL1	29
BK5-19	31	BK6-23	31	BK10-14	32	BLL3	29
BK5-20	31	BK6-24	31	BK10-15	32	BLT1R	164
BK5-21	31	BK6-25	31	BK10-16	32	BLV3	29
BK5-22	31	BK6-26	31	BK10-17	32	BM1	27
BK5-23	31	BK6-27	31	BK10-18	32	BM2	27
BK5-24	31	BK6-28	31	BK10-19	32	BMB1	32
BK5-25	31	BK6-29	31	BK10-20	32	BMB1R	32
BK5-26	31	BK6-30	31	BK10-21	32	BMB2	32
BK5-27	31	BK6-31	31	BK10-22	32	BMB3	32
BK5-28	31	BK6-32	31	BK10-23	32	BMB3R	32
BK5-29	31	BK6-33	31	BK10-30	32	BMB4	32
BK5-30	31	BK6-34	31	BK11R	31	BMB4R	32
BK5-31	31	BK6-35	31	BK13	30	BMB5	32
BK5-32	31	BK7R-1	30	BK15	30	BN2	29
BK5-33	31	BK7R-2	30	BK16	30	BN2R	29
BK5-34	31	BK7R-3	30	BK17	30	BNK1	32-206
BK5-35	31	BK7R-4	30	BK18	30	BO2	33
BK6-1	31	BK7R-5	30	BK20	30	BO2R	33
BK6-2	31	BK7R-6	30	BK21R	30	BO6	33
BK6-3	31	BK7R-7	30	BK22R	30	BO6R	33
BK6-4	31	BK7R-8	30	BK23R	30	BOR1	33
BK6-5	31	BK7R-9	30	BK26	31	BOR1R	33
BK6-6	31	BK7R-10	30	BK27	30	BOS1	33

Ref.	Page	Ref.	Page	Ref.	Page	Ref.	Page
CB23R	54	CB96R	53	CE11R	42	CE22-36	43
CB24R	54	CB97	54-208	CE12	43	CE22-37	43
CB25R	54	CB98	54-208	CE13	42	CE22-38	43
CB26R	54	CB99R	53	CE13R	42	CE22-45	43
CB27R	54	CB100R	53	CE14-15	43	CE22-46	43
CB28R	54	CB101R	53	CE14-16	43	CE22-47	43
CB29	54	CB102R	55	CE14-17	43	CE22-48	43
CB29R	54	CC1	55	CE14-18	43	CE23R	43
CB2R	52	CC1R	55	CE14-25	43	CE24R	43
CB30	53	CC2	55	CE14-26	43	CE25R	43
CB30R	53	CC2R	55	CE14-27	43	CE26R	43
CB31	53	CC3	55	CE14-28	43	CE27	43
CB32	53	CC3R	55	CE14-35	43	CE28	43
CB33R	54	CC4	55	CE14-36	43	CE29R	41
CB34R	54	CC5	55	CE14-37	43	CE30	42
CB37	54	CC6R	55	CE14-38	43	CE30R	42
CB38	54	CC7	55	CE14-45	43	CE31	43
CB38R	54	CC7R	55	CE14-46	43	CE32R	43
CB39R	54	CC8	55	CE14-47	43	CE33	42
CB40R	54	CCC1	41	CE14-48	43	CE34	41
CB41R	54	CCC1R	41	CE15	43	CE35	41
CB42	53	CE1	42	CE16	43	CE36	41
CB43R	53	CE1R	42	CE17WPS	43	CE39	43
CB44R	54	CE2	42	CE17XPS	43	CE3R	42
CB70	53	CE2R	42	CE18	41	CE40	42
CB78R	53	CE2X	42	CE18R	41	CE41	42
CB79	52	CE3	42	CE19	42	CE41XL	42
CB80	52	CE4	41	CE19R	42	CE41X-OV	42
CB81	52	CE4R	41	CE20	43	CE127	43
CB82	54	CE5	42	CE21R	41	CE129-1	44
CB83	53	CE6	41	CE22-15	43	CE129-2	44
CB84	53	CE6R	41	CE22-16	43	CE129-3	44
CB85	53	CE7	41	CE22-17	43	CE129-4	44
CB86	53	CE7R	41	CE22-18	43	CE129-5	44
CB87	54-208	CE8	41	CE22-25	43	CE129-6	44
CB88R	53	CE9	41	CE22-26	43	CE129-7	44
CB89R	53	CE10	41	CE22-27	43	CE129-8	44
CB90R	53	CE11	42	CE22-28	43	CE129-9	44
CB95R	53	CE114	43	CE22-35	43	CE129-10	44

Ref.	Page	Ref.	Page	Ref.	Page	Ref.	Page
CE129-11	44	CE129-50	44	CE129-89	44	CEE1	41
CE129-12	44	CE129-51	44	CE129-90	44	CEN1	41
CE129-13	44	CE129-52	44	CE130-1	44	CEN1R	41
CE129-14	44	CE129-53	44	CE130-2	44	CEN2	41
CE129-15	44	CE129-54	44	CE130-3	44	CEN2R	41
CE129-16	44	CE129-55	44	CE130-4	44	CEN3	41
CE129-17	44	CE129-56	44	CE130-5	44	CEN4R	41
CE129-18	44	CE129-57	44	CE130-6	44	CEN5T	41
CE129-19	44	CE129-58	44	CE130-7	44	CF1	47
CE129-20	44	CE129-59	44	CE130-8	44	CF1R	47
CE129-21	44	CE129-60	44	CE130-9	44	CF2	47
CE129-22	44	CE129-61	44	CE130-10	44	CF2R	47
CE129-23	44	CE129-62	44	CE130-11	44	CF3	47
CE129-24	44	CE129-63	44	CE130-12	44	CF4	47
CE129-25	44	CE129-64	44	CE130-13	44	CH1	45
CE129-26	44	CE129-65	44	CE130-14	44	CH2	45
CE129-27	44	CE129-66	44	CE130-15	44	CH3	45
CE129-28	44	CE129-67	44	CE130-16	44	CH4	45
CE129-29	44	CE129-68	44	CE130-17	44	CH5	45
CE129-30	44	CE129-69	44	CE130-18	44	CH6	45
CE129-31	44	CE129-70	44	CE130-19	44	CH7	45
CE129-32	44	CE129-71	44	CE130-20	44	CH7R	45
CE129-33	44	CE129-72	44	CE130-21	44	CH8	45
CE129-34	44	CE129-73	44	CE130-22	44	CH9T	46
CE129-35	44	CE129-74	44	CE130-23	44	CH10	45
CE129-36	44	CE129-75	44	CE130-24	44	CH11	45
CE129-37	44	CE129-76	44	CE130-25	44	CH12	45
CE129-38	44	CE129-77	44	CE130-26	44	CH13	45
CE129-39	44	CE129-78	44	CE130-27	44	CH14	45
CE129-40	44	CE129-79	44	CE130-28	44	CH15	45
CE129-41	44	CE129-80	44	CE130-29	44	CH16T	46
CE129-42	44	CE129-81	44	CE130-30	44	CH17T	46
CE129-43	44	CE129-82	44	CE130-31	44	CH18	45
CE129-44	44	CE129-83	44	CE130-32	44	CH19	45
CE129-45	44	CE129-84	44	CE130-33	44	CH24R	45
CE129-46	44	CE129-85	44	CE130-34	44	CH27	45
CE129-47	44	CE129-86	44	CE130-35	44	CHS1	46
CE129-48	44	CE129-87	44	CE131	45-207	CHU5	46
CE129-49	44	CE129-88	44	CE147	41	CHU6	46

Ref.	Page	Ref.	Page	Ref.	Page	Ref.	Page
CHU7	24	CLU3	51	CS7	50	CS27	50
CHV1	45	CLU3R	51	CS7R	50	CS27R	50
CHV1R	45	CLU4	51	CS8	50	CS28	51-196
CIA1	46	CLU4R	51	CS8R	50	CS28R	51-196
CIL1	47	CLU5	51	CS9	50	CS30	48
CIL1R	47	CLU5R	51	CS9R	50	CS30R	48
CIL2	47	CM1	41	CS10	50	CS31	48
CIL2R	47	CM1R	41	CS10R	50	CS31R	48
CIL3	47	CM2	41-86	CS11	50	CS32	36-50
CIL5	47	CM2R	41-86	CS12	13-50	CS32R	36-50
CIL6	47	CM3	41	CS12R	13-50	CS33	36-50
CIL7	47	CM3R	41	CS13	48	CS33R	36-50
CIS1	40	CM4	41	CS13R	48	CS34	48
CIS2	40	CM4R	41	CS13X	49	CS34R	48
CIS3	40	CNP1R	52	CS14	48	CS36	48
CIS4	40	CO1	55	CS14R	48	CS37	48
CIS4R	40	CO1R	55	CS15	48	CS37R	48
CIS5	40	COL1	52	CS15R	48	CS38	48
CIS5R	40	COL2	52	CS16	48	CS38R	48
CIS6	40	COL3	52	CS16R	48	CS41	48
CIS6R	40	COL4	52	CS17	48	CS42	48
CIS7	40	COR1	55	CS17R	48	CS43	48
CIS8	40	COR2	55	CS18	48	CS44	48
CIS9	40-207	COR2R	55	CS18R	48	CS44R	48
CIS11	40	CR2R	51	CS19	50	CS45	51
CIS12	40-207	CR5R	51	CS19R	50	CS45R	51
CK1	45	CRE401	244	CS20	51	CS46	48
CKM1	157	CRE402	244	CS21	50	CS46R	48
CLK1	45	CRE403	244	CS21R	50	CS47	48
CLL1	52	CRE404	244	CS22	50	CS47R	48
CLS1	46	CRE405	244	CS22R	50	CS48	49-207
CLS2	46	CRE406	244	CS23	36-51	CS49	48
CLS3	46	CRL1	47-207	CS23R	36-51	CS50	48
CLS220	46	CS4	49	CS24	48	CS52X	49
CLS242	46	CS4R	49	CS24R	48	CS61	49
CLU1	51	CS5	50	CS25	48	CS62	49-208
CLU1R	51	CS5R	50	CS25R	48	CS62P	49-208
CLU2	51	CS6	50	CS26	36-50	CS66	49
CLU2R	51	CS6R	50	CS26R	36-50	CS67	48

Ref.	Page	Ref.	Page	Ref.	Page	Ref.	Page
CS68	48	CU402	244	DB8R	60	DB28	60
CS70	49-208	CU405	244	DB9	60	DB28R	60
CS70P	49-208	CU413	244	DB9R	60	DB29	60
CS85	48	CV1	40	DB10	60	DB29R	60
CS88	48	CV2	40	DB10R	60	DB30	60
CS105	48	CV3	40	DB11	60	DB30R	60
CS115	49-208	CVL1	56	DB11R	60	DB31	60
CS116P	49-208	CVL1R	56	DB12	60	DB31R	60
CS119	49	CVL2	56	DB12R	60	DB32	60
CS119R	49	CVL2R	56	DB13	60	DB32R	60
CS120	49	CVL3	56	DB13R	60	DB33	60
CS120R	49	CVL3R	56	DB14	60	DB33R	60
CS121	49	CVL4	56	DB14R	60	DB34	60
CS138	48	CVL5R	56-208	DB15	60	DB34R	60
CS139	49-208	CW1	56	DB15R	60	DB35	60
CS139P	49-208	CX7	243	DB16	60	DB35R	60
CS140	49-208	CYS1	40	DB16R	60	DB36	60
CS141	49-208	CYS1R	40	DB17	60	DB36R	60
CS142	48	CYS2	41-207	DB17R	60	DB37	60
CS143	48			DB18	60	DB37R	60
CS144	49-208			DB18R	60	DB38	60
CS145	49-208			DB19	60	DB38R	60
CS146	49-208			DB19R	60	DB39	60
CS147	48			DB20	60	DB39R	60
CS152	49			DB20R	60	DB40	60
CS204	48			DB21	60	DB40R	60
CS205	48			DB21R	60	DB41	60
CS206	48			DB22	60	DB41R	60
CS207	48			DB22R	60	DB42	60
CS20R	51			DB23	60	DB42R	60
CS500	48			DB23R	60	DB43	60
CS500R	48			DB24	60	DB43R	60
CS501	48			DB24R	60	DB44	60
CS501R	48			DB25	60	DB44R	60
CS1003	243			DB25R	60	DB45	60
CT1	56			DB26	60	DB45R	60
CT1R	56			DB26R	60	DB46	60
CT2	56			DB27	60	DB46R	60
CT2R	56			DB27R	60	DB47	60

Ref.	Page	Ref.	Page	Ref.	Page	Ref.	Page
DB47R	60	DFE1RP	57-208	DM12-4	64	DM12-43	64
DB48	60	DFE2P	57-208	DM12-5	64	DM12-44	64
DB48R	60	DFE3RAP	57-209	DM12-6	64	DM12-45	64
DB49	60	DIR1R	59-209	DM12-7	64	DM12-46	64
DB49R	60	DK1	57-209	DM12-8	64	DM12-47	64
DB50	60	DK3	57-209	DM12-9	64	DM12R-00	64
DB50R	60	DK4	57	DM12-10	64	DM12R-12	64
DB51	60	DK5	57	DM12-11	64	DM12R-13	64
DB51R	60	DK6	57-209	DM12-12	64	DM12R-16	64
DB53	60	DK7	57-209	DM12-13	64	DM12R-19	64
DB53R	60	DK8R	57	DM12-14	64	DM12R-31	64
DB54	60	DK9R	57	DM12-15	64	DM12R-32	64
DB54R	60	DL1R	59-110	DM12-16	64	DM12R-34	64
DB55	60	DL2	59-110	DM12-17	64	DM12R-35	64
DB55R	60	DL3	59-110	DM12-18	64	DM12R-36	64
DB56	60	DLC1	58-209	DM12-19	64	DM13	60
DB56R	60	DLC1R	58-209	DM12-20	64	DM14	62
DB57	60	DLC2R	58-209	DM12-21	64	DM16	61
DB57R	60	DLC3	58-209	DM12-22	64	DM16R	61
DB58	60	DM2	60	DM12-23	64	DM17	63
DB58R	60	DM2R	60	DM12-24	64	DM17R	63
DB59	60	DM3	62	DM12-25	64	DM18	64
DB59R	60	DM3X	62	DM12-26	64	DM18R	64
DB60	59	DM4	61	DM12-27	64	DM19	61
DC1	56	DM4R	61	DM12-28	64	DM19R	61
DCR1	67	DM5	60	DM12-29	64	DM20	62
DCR2	67	DM5R	60	DM12-30	64	DM21	63-210
DD1	56	DM6	61	DM12-31	64	DM22	62-210
DD2	56	DM6R	61	DM12-32	64	DM22TV1	62-210
DD3	56	DM7	62	DM12-33	64	DM22TV2	62-210
DD4	56	DM8	61	DM12-34	64	DM22TV3	62-210
DD5	56	DM8R	61	DM12-35	64	DM22TV4	62-210
DD6	56	DM10	61	DM12-36	64	DM22TV5	62-210
DD7	56	DM10R	61	DM12-37	64	DM22TV5X	63-210
DD8	56	DM11	62	DM12-38	64	DM22TV6	62-210
DEA2	57	DM12-00	64	DM12-39	64	DM22TV7	62-210
DF3	56	DM12-1	64	DM12-40	64	DM22TV8	62-210
DF3R	56	DM12-2	64	DM12-41	64	DM22TV9	62-210
DF4R	56-208	DM12-3	64	DM12-42	64	DM22TV10	62-210

Ref.	Page	Ref.	Page	Ref.	Page	Ref.	Page
DM22TVP	62-210	DM47R	64	DM65-23	65	DM70	64
DM22TVPX	63-210	DM48	62	DM65-24	65	DM70R	64
DM23	60	DM49	63-209	DM65-25	65	DM71	64
DM23R	60	DM50	64	DM65-26	65	DM71R	64
DM24	63-209	DM52	61	DM65-27	65	DM72	64
DM25	62	DM53	63-209	DM65-28	65	DM72R	64
DM26	64	DM55	63-210	DM65-29	65	DM73	64
DM26R	64	DM57	61	DM65-30	65	DM73R	64
DM27	63	DM58	63-210	DM65-31	65	DM74	64
DM28	62	DM60	64	DM65-32	65	DM74R	64
DM29	64	DM61	61	DM65-33	65	DM75	64
DM29R	64	DM61R	61	DM65-34	65	DM75R	64
DM32	62	DM62	60	DM65-35	65	DM76	65
DM33R	64	DM62R	60	DM65-36	65	DM76R	65
DM34	61	DM63	61	DM65-40	65	DM77	65
DM34R	61	DM63R	61	DM65-41	65	DM77R	65
DM35R	62	DM64	63-209	DM65-42	65	DM78	65
DM36	61	DM65-00	65	DM65-43	65	DM78R	65
DM36R	61	DM65-1	65	DM65-44	65	DM79	65
DM37	61	DM65-2	65	DM65-45	65	DM79R	65
DM37R	61	DM65-3	65	DM65-46	65	DM80	65
DM38	61	DM65-4	65	DM65R-00	65	DM80R	65
DM39	61	DM65-5	65	DM65R-12	65	DM81	65
DM39R	61	DM65-6	65	DM65R-13	65	DM81R	65
DM40	64	DM65-7	65	DM65R-16	65	DM82	65
DM40R	64	DM65-8	65	DM65R-19	65	DM82R	65
DM41	61	DM65-9	65	DM65R-31	65	DM83	65
DM41R	61	DM65-10	65	DM65R-32	65	DM83R	65
DM42	64	DM65-11	65	DM65R-34	65	DM84	65
DM42R	64	DM65-12	65	DM65R-35	65	DM84R	65
DM43	64	DM65-13	65	DM65R-36	65	DM85	65
DM43R	64	DM65-14	65	DM66	64	DM85R	65
DM44	64	DM65-16	65	DM66R	64	DM86	65
DM44R	64	DM65-17	65	DM67	64	DM86R	65
DM45	64	DM65-18	65	DM67R	64	DM87	65
DM45R	64	DM65-19	65	DM68	64	DM87R	65
DM46	64	DM65-20	65	DM68R	64	DM88	65
DM46R	64	DM65-21	65	DM69	64	DM88R	65
DM47	64	DM65-22	65	DM69R	64	DM89	65

Ref.	Page	Ref.	Page	Ref.	Page	Ref.	Page
DM89R	65	DM123-3	62	DRS1R	67	EF3R	68
DM90	65	DM123-4	62	DS1	66	EF4R	68
DM90R	65	DM123-6	62	DS1R	66	EF5R	68
DM91	65	DM123-7	62	DS2	66	EF6R	68
DM91R	65	DM123-8	62	DS3R	66	EF7	68
DM92	65	DM123-9	62	DS4	66	EG1	67
DM92R	65	DM123-10	62	DS5R	66	EG2	67
DM93	65	DM128	63-210	DS6	66-210	EG2R	67
DM93R	65	DM137	61	DS7	66-210	EK1	70
DM94R	65	DM138	63-210	DW1	67	EK1R	70
DM95	65	DM139	63-210	DX1	58	EK2R	70
DM95R	65	DM13R	60	DX1R	58	EK3	70
DM96	60	DM141R	62	DX2R	58	EK3R	70
DM97R	62	DM144	63-210	DX3	58	EK4	70
DM98R	62	DM145	63-210	DX3R	58	EL1	68
DM101	61	DM149	61	DX4R	58	EL1C	68
DM102	61	DM150	62	DX6R	58	EL1X	68
DM103	62	DMT1R	59	DX13R	58	EL2	68
DM104R	60	DMT2R	59	DX15R	58	EL3	68
DM105R	62	DN1	58	DX17R	58	EL4	68
DM106	60	DN2	58	DX18R	58	EL5R	68
DM108	65	DN3	58	DY1	57	EL6	68
DM108R	65	DN4	58	DY1R	57	EL7R	68
DM109	65	DN5	59	E		EL9	68-210
DM109R	65	DN6	59	EA1	67	EL10	68
DM110	61	DN7	59	EA2	67	ELK1	68
DM111	61	DN8	59	EA3	67	ELP1R	68
DM112	61	DN9R	58	EA4	67	EM1	69
DM113	61	DO1R	66	EAS1	67	EM1R	69
DM114	61	DO2R	66	EC5	68-166-210-221	EM2R	69
DM115	64	DO6	66	ECM1	67	EM3	69
DM115R	64	DO10	66	ECM1R	67	EM3R	69
DM116	61	DO11	66	ED1	71	EM4	69
DM118	63-209	DO12	66	ED2	71	EM11	69
DM119	62	DO13	66	ED3R	71	EMK1	69
DM120	63-209	DOW1R	67	ED4	71	EMK2	69
DM122	63-209	DP1	67	EF1R	68	EMK3R	69
DM123-1	62	DP1R	67	EF2R	68	EMK5	69
DM123-2	62	DRC1	67			EMK6R	69

Ref.	Page	Ref.	Page	Ref.	Page	Ref.	Page
FB17RX	74	FB81	74	FF18	79	F11	79
FB18R	74	FB81R	74	FH1	82	F13R	79-212
FB18RX	74	FD1	81	FH1R	82	F14R	79-212
FB19R	74	FDR1	78	FH2	82	FI064	79
FB19RX	74	FDR2	78	FH2R	82	FI065	79
FB20R	74	FEB1	46-78	FH3	82	FI232	79
FB20RX	74	FEB1R	46-78	FH3R	82	FI233	79
FB20X	74	FEB2	46-78	FH4	82	FI234	79
FB21R	74	FEB2R	46-78	FH4R	82	FI235	79
FB21RX	74	FEB6R	78	FH5	82	FID1	80
FB22R	74	FF1	78	FH6	82	FIR1	80
FB22RX	74	FF1R	78	FH7	81	FIR1R	80
FB23	74	FF2	78	FH8R	82	FIR3	80
FB23R	74	FF3	78	FH9	82	FIS1	81
FB24	74	FF3R	78	FH9R	82	FIS1R	81
FB25R	74	FF4	79	FH10R	82	FIS3	81
FB25RX	74	FF4R	79	FH11	82	FK1	81
FB26	74	FF5	79	FH12	83-212	FL2	81
FB26R	74	FF5R	79	FH13	82	FL2R	81
FB27R	74	FF6	79	FH14	82	FLM1P	81
FB28R	74	FF6R	79	FH15	82	FM1	77
FB28RX	74	FF7	78	FH16R	82	FM2	77
FB33	74	FF7R	78	FH17R	83-212	FM3	77
FB33R	74	FF8	78	FH18	82	FM3R	77
FB34R	74	FF8R	78	FH19R	82	FM4	77
FB35R	74	FF9	78	FH20R	82	FM4R	77
FB36	74	FF9R	78	FH21R	83	FM5	77
FB36R	74	FF10	78	FH22R	83	FM5P	77
FB39X	74	FF10R	78	FH23R	83	FM6	77
FB42R	74	FF11	79	FH24R	83	FM7	77
FB57R	74	FF11R	79	FH25	82	FM8	77
FB62RX	74	FF12	79	FH30	82	FM090	77
FB62X	74	FF12R	79	FH31L	82	FMK1	59
FB63X	74	FF13	79	FH32	83-212	FN1	76
FB64RX	74	FF13R	79	FH33	83-212	FN2	76
FB64X	74	FF14	78	FH34R	83-212	FN4	76
FB65R	74	FF15	78	FH35	83-212	FOS1	81
FB69RX	74	FF16	79	FH36	83-212	FRE1R	81
FB75R	74	FF17	78	FH37R	83-212	FRN1R	78

Ref.	Page	Ref.	Page	Ref.	Page	Ref.	Page
FRT1	81	GD3	91	GE27R	85	GL10	87
FRT4R	81	GD4	90	GE28	85	GL10R	87
FRT5R	81	GD5	90	GE28R	85	GL11R	87
FRT6R	81	GD6R	91	GE29	85	GL12R	87
FRT7	81	GD7R	91	GE29R	85	GL13R	87
FRT8	81	GD8	90	GE30	85	GL14	88
FRT9R	81	GD8R	90	GE30R	85	GL17R	88
FRZ1	81	GE1	84	GE31	85	GL18R	88
FRZ2	81	GE1R	84	GE31R	85	GL19R	88
FS1	76	GE1RX	84	GE32	85	GL20	89
FS1R	76	GE1X	84	GE34	84	GL21R	88
FT3	80	GE2	85	GE34X	84	GL22R	88
FT4	80	GE2R	85	GE52X	84	GLZ1	87
FT4C	80	GE3	85	GE57	84-213	GN1	86
FT5C	80	GE3R	85	GE106	85	GO1R	88
FT500	80	GE4	84	GE106XL	85	GO2R	88
FT500C	80	GE4R	84	GE118	85	GO3	88
FT510	80	GE4RX	84	GE119	84	GO4R	88
FV1	78	GE4X	84	GE119X	84	GO5	88
FV2	78	GE7R	84	GEA4	84	GO6	89-213
FV4	78-212	GE7RX	84	GF1	90-213	GO7	89-213
FVR1	77-211	GE8R	84	GJ3	89	GOD4R	89
FVR2R	77-211	GE9	84	GL1	88	GP1	86
FVR3	77-211	GE14	85	GL1R	88	GPI1	89-213
FVR4R	77-211	GE15	85	GL2	88	GR1R	85
FY1R	77-212	GE15R	85	GL2R	88	GR2R	85
		GE16R	85	GL3	88	GR3	85
		GE17	85	GL3R	88	GR4	85
		GE19R	85	GL4	88	GR9-5	85
G		GE20	85	GL4R	88	GR9-7	85
GB1	84	GE21R	85	GL5	88	GR9-8	85
GB2	84	GE22	85	GL5R	88	GR9-9	85
GB3	84	GE24	85	GL6	87	GR9R-1	85
GB5	84	GE24R	85	GL6R	87	GR9R-3	85
GB5R	84	GE25	85	GL7	87	GS1	86
GBA1	84	GE25R	85	GL7R	87	GS1R	86
GBL1R	87	GE26	85	GL8	87	GS2	86-127
GD1	91	GE26R	85	GL9	87	GS2R	86-127
GD1R	91	GE27	85	GL9R	87	GS3	34-86
GD2	90						

Ref.	Page	Ref.	Page	Ref.	Page	Ref.	Page
IE6	97	IF14	95-213	JAR1	99	JPN1	99
IE6R	97	IJ1	95	JAR1R	99	JPN2	99
IE7	97	IL1	95	JAR2	99	JPN3R	99
IE7R	97	IL1R	95	JAR2R	99	JR1R	101
IE8	97	ILC2	96	JB1	99	JS1	99
IE8R	97	ILC6	96	JC1	101	JS1R	99
IE9	97	ILC13R	96	JC2R	101	JS2	99
IE10	97	ILS1	96	JH1	99	JS2R	99
IE12	97	IN1	96	JL1	102	JS3	99
IE13	97	IN2	96	JL2	102	JS3R	99
IE14	98-213	IN3	96	JL2R	102	JS4	99
IE15	98-213	IN5	96	JL3	102	JS4R	99
IE26	98-214	ING1	96	JL3R	102	JS5P	99
IE26P	98-214	ING2	96	JL4	102	JT1	100
IE27R	97	ING3	97	JL4R	102	JT2R	100
IE28R	97	ING4R	97	JL5	102	JT3R	100
IE29	98	ING5	96	JM1	6-100	JU1	101
IE30	98-214	ING6	96	JM1R	6-100	JU1R	101
IE31	97	INS1	97	JM2	6-100	JU2	101
IE224	97	IO1	98-214	JM2R	6-100	JU2R	101
IE225	97	IR1	97-213	JM3	100	JU3	101
IEH1	193	IS1	95	JM3R	100	JU4	101
IES1R	95	IS2	95	JM6	100	JU5	101
IF1	95	ISP2	94	JM7	100	JU6	101
IF2	95	ISP4	94	JN1R	101	JU7	101
IF2R	95	IT1	97	JOW1	100	JU8	101
IF3	95	IT1R	97	JOW1R	100	JU9	101
IF3R	95	IT2	97	JOW2	100	JU10	101
IF4	95	IT2R	97	JOW3R	100	JU11	100
IF4R	95	ITO1R	98	JOW4R	100	JU11R	100
IF5	95	ITO2	98	JOW5	100	JU12	100
IF5R	95	ITO3	98	JOW6	100	JU13R	100
IF6	95	ITO3R	98	JOW7	100	JU14	101
IF7	95	IW1R	99	JOW8	100	JW1	101
IF7R	95	IX1	94	JOW9	100	JW1R	101
IF8	95	IX1R	94	JOW10	100	JW2	101
IF8R	95			JOW11	100	JW2R	101
IF12R	95			JOW12RX	100	JW3	102
IF13R	95			JOW12X	100	JW4R	101

J

Ref.	Page
JW5	101
JW6	101
JW7R	101
JW8	101
JW9	101
JW11	102
JW12	101
JW13	101
K	
KA1	102-214
KA2	102-214
KA3	102-214
KA4	103-214
KA5	103-214
KA6	102-214
KA7	102-214
KA8	103-214
KA9	103-214
KAK1	103-214
KAP1	104
KAP1R	104
KAZ1R	104
KAZ2	104
KAZ2R	104
KAZ3R	104
KAZ4R	104
KAZ5R	104
KAZ7R	104
KAZ8R	104
KE1	104-215
KE2	105-215
KE3	105-215
KE4	105-150-215
KE9	105-215
KE11	105-215
KE13	105-215
KEI1R	104

Ref.	Page
KEY1	105
KEY1R	105
KF1	105
KFA	105
KFB	105
KFC	105
KFD	105
KFE	105
KFF	105
KFG	105
KFH	105
KFI	105
KFJ	105
KFK	105
KFL	105
KFM	105
KFN	105
KFO	105
KFR	105
KFS	105
KFU	105
KFW	105
KFX	105
KG2	107
KI4	106
KI4R	106
KI5	106-145
KI5R	106-145
KI6	106
KI7	106-145
KI7R	106
KI8	84-106
KI8R	84-106
KI9	106
KI9R	106
KI10	84-106
KI10R	84-106
KI11	106
KI11R	106

Ref.	Page
KI12	106-145
KI12R	106-145
KI13	106
KI14	106
KI15	106
KI15R	106
KI16	106
KIR1	107
KIV1R	107
KIV2R	107
KK1	188
KL1	107
KL1R	107
KL2	107
KL2R	107
KLE1	103-215
KLE2R	103-215
KLE3R	103
KLE3RX	103
KLE3X	103
KLE4	103-215
KLE5RX	103
KLE5X	103
KLE6RX	103
KLE6X	103
KLE7RX	103
KLE7X	103
KLE8R	103-215
KLE9R	103-215
KLE10R	103-215
KLG1R	104
KLG2R	104
KM1	107
KM1R	107
KMT1	107
KMT2R	107
KNA1	108
KNA2	108
KOB1	107

Ref.	Page
KP1	107
KPP1	107
KRE1	107
KS1	108
KS1FT	108
KS4	108
KZ1	106
KZ2	106
KZ3	106
L	
LAF1	108
LAF2	108
LAF4R	108
LAF5	109
LAF6	109
LAF7	109
LAF8	109
LAP1	110
LAP2	59-110
LAP3	59-110
LB10	111
LB11	111
LB18	111
LB19	111
LB22	111
LB23	111
LB28	111
LB29	111
LB32	111
LB33	111
LB34	111
LB35	111
LC1	112
LC1R	112
LC2	112
LC2R	112
LC3	112
LC3R	112

Ref.	Page	Ref.	Page	Ref.	Page	Ref.	Page
LC4	112	LF8R	71-116	LF58R	117	LMA1	109
LC4R	112	LF11	71-116	LF59R	117	LN1	114
LC5	112	LF11R	71-116	LF60	117	LOB1	114
LC5R	112	LF13	71-116	LF61R	117	LOB1R	114
LC6	112	LF15R	71-116	LH1	109	LOB16	114
LC6R	112	LF16	71-116	LH2	110	LOC1	114
LC7	112	LF16R	71-116	LH3	110	LOC3	114
LC7R	112	LF17	71-116	LH4	109	LOC4	114
LC8	112	LF18R	70-116	LH5	110	LP2	112
LC8R	112	LF20	71-116	LH5R	110	LP2R	112
LC9R	112	LF20R	71-116	LH6R	110	LP3	113
LC10	112	LF22	71-116	LH7R	110	LP3R	113
LC11	112	LF22R	71-116	LH10	110	LP5	112
LC11R	112	LF23R	71-116	LH10R	110	LP5R	112
LC12	112	LF24	116	LH13P	109-216	LP6	113
LC13	112	LF25	116	LH14P	109-216	LP7	112
LC13R	112	LF26	71-116	LH15P	109-216	LP7R	112
LC14R	112-216	LF27	116	LH16P	109-216	LP8	112
LC15	112	LF27R	116	LH17P	109-216	LP8R	112
LC15R	112	LF28R	117	LH18P	109-216	LP9	113
LC16	112	LF29R	71-116	LH20	110	LP9R	113
LC17	112	LF30R	71-116	LH21	110	LP10	113
LC17R	112	LF31R	117	LH22	110	LP10R	113
LCK1R	114-216	LF33	117	LH23	110	LP11	105-113-215-216
LCK1RX	114-216	LF34	117	LH24	110	LP12	112
LD4	108	LF37	116	LH25	110	LP12R	112
LD4R	108	LF39	117	LH26	110	LP13	112
LD5R	108	LF42R	116	LH27	110	LP13R	112
LEA1	111-216	LF43R	116	LH28	110	LP14	113
LEA2	111	LF45R	117	LH29	110	LP14R	113
LEG1	111	LF46R	117	LH40	109	LP15	113
LEG2	111	LF47	117	LH41P	109-216	LP15R	113
LEG3	111	LF4R	70-116	LH42	109	LP16	113
LF2	71-116	LF51R	117	LL1	111-115	LP16R	113
LF4	70-116	LF52	116	LM3	118	LP17R	112
LF6	70-116	LF53	117	LM3R	118	LP18R	112
LF6R	70-116	LF54	117	LM4	118	LP19R	112
LF7	71-116	LF56	117	LM4R	118	LP20R	112
LF8	71-116	LF57	116	LM5P	118	LP21	113

Ref.	Page	Ref.	Page	Ref.	Page	Ref.	Page
ME9	122	MER35R	124	MIW1	127	MON1R	128
ME10R	122	MER36	124	MIW2	127	MP101	129
MEC1	121	MER37	124	MIW3	127	MP102	130
MEG1R	122-217	MER38	125-217	MIW5	127	MP103	130
MEG2	122-217	MER39	124-217	MIW6	127	MP104	130
MER1	123	MER41	125	MIW7	127	MP105	130
MER1R	123	MET1	125-136	MIW13	127	MP228	129
MER2	123	MF1R	122	MIW14	127	MP229	129
MER4	123	MFA1	122	MIW15	127	MP230	129
MER4R	123	MG1	125	MLE1	122	MP231	129
MER5	123	MG1R	125	MLE2	122	MR1	118
MER6	123	MG2	125	MLM1	127	MS1	119
MER6R	123	MG2R	125	MLM1R	127	MS2	119
MER7R	123	MG3	125	MLM2	127	MS3	119
MER8	124	MG8	125-217	MLM3R	127	MS3R	119
MER9R	124	MG9	126-217	MLM4R	127	MS4R	119
MER10R	124	MGN1RP	118-216	MLM5	127-217	MS5R	119
MER11R	124	MH1	126-142	MLM6R	127	MS6	119
MER12R	124	MH1R	126-142	MLM7R	127	MS7	119
MER13R	124	MH2	136-142	MLN1	126	MS8	118
MER14R	124	MH2R	136-142	MLN3	126	MS9R	119
MER15R	124	MH4	142	MN1	128	MS10	119
MER16R	124	MH4R	142	MN2	128	MS11	119
MER17R	124	MH5R	126	MN2R	128	MS11R	119
MER18R	124	MI1	128	MN3	128	MS12	119
MER19R	124	MI1R	128	MN3R	128	MS13R	119
MER20R	124	MI2	128	MN4R	128	MS14	119
MER21R	124	MI2R	128	MN5	128	MS16	119
MER22T	124	MI3	129	MN5R	128	MS17	119
MER23	123	MI5	128	MN6	128	MS19	119
MER24	123	MI5R	128	MN6R	128	MS20P	119-216
MER25T	124	MI7	129	MN7	128	MS21AP	119
MER26T	124	MI7R	129	MN7R	128	MS22	119-216
MER27	123	MIG1	129	MN8	128	MS23	119-216
MER29	123	MIG2	129	MN8R	128	MSC1	129
MER31	123	MIL1	126	MN9	128	MSF1	130
MER32	123	MIL2	126	MN9R	128	MSL1	119-216
MER33R	124	MIS1	126-243	MOD1	128	MST1	129
MER34R	124	MIS2	126-243	MON1	128	MSV1	130

Ref.	Page	Ref.	Page	Ref.	Page	Ref.	Page
MSV1R	130	MU404	245	O		OJ13R	134
MSV2	130	MUL1	130		OJ14	134-218	
MSV2R	130	MUL2	130		OJ15RP	134	
MTA1R	125	MX1	125		OJ16R	133	
MTA2	125-217	MX5	125		OJ18	134-218	
MTA3R	125	MXU1R	120		OL4	134	
MTA4	125-217				OL5	134	
MTK1	130-218	N			OL5R	134	
MTK2P	130-218		NAB1		131	OL6	134
MTK3P	130-218		NAB1R		131	OLT1	134
MTK4P	130-218		NAB2		131	OLT2	134
MTK4RP	131-218		NAB3R		131	OLT3	135
MTK4RPX	131-218		NAB4	131	OLT4	134	
MTK5	130		NAB5	131	OLT5	134	
MTK5R	130		NAB6	131	OLT6R	134	
MTK7RP	131-218		NCR1	132	OLT7	135	
MTK8RP	131-218		NCR1R	132	OLT8R	134	
MTK9RP	131-218		NCR2	132	OMR1R	136	
MTK10RP	131-218		NCR3	132	ON1	136	
MTK11R	130-218	NCR4	132	ON1R	136		
MTK12R	130-218	NCR6	132	OR1R	136		
MTK12RP	131-218	NCR11R	132	ORA1	136		
MTK13R	130-218	NCR12	132	ORA2	136		
MTK13RAP	131-218	NCR13	132	ORO1	136		
MTK14RP	131-218	NCR19	132	ORO2	136		
MTK15R	130-218	NEC1	132	OV1	136		
MTK15RAP	131-218	NF1	132	OV1R	136		
MTK16	130-218	NF1R	132	OV2	136		
MTL1	130-217	NK1	131	OV2R	136		
MTS1	129	NK2	131	OV3	136		
MTS1R	129	NK3	131	OV3R	136		
MTT1R	129	NME1R	132	P			
MTT2R	129	NME2R	132		PA1	139	
MTY1	126	NN1	132		PA1R	139	
MTY2	126	NP1R	132		PA2	139	
MTZ1	106	NR1R	131		PA2R	139	
MU401	245				PAC1R	137	
MU402	245						
MU403	245						

Ref.	Page	Ref.	Page	Ref.	Page	Ref.	Page
RC5R	48	RIQ11R	90	RO38	147	RU12	148
RC6	48	RL1	243	RO38R	147	RU13	148
RC6R	48	RM1A	145	RO41	146-181	RU14	148
RC7R	48	RM1RA	145	RO42	147	RU15R	148
RD1	146	RM2A	145	RO42R	147	RU16	148
RD2	146	RM2RA	145	RO43R	146	RU19	148
RDC1	144	RO4	147	RO44	147	RU20	148
REL1R	144	RO4R	147	RO44R	147	RU21	148
REL2	144	RO7	147	RO45	147	RU22R	148
REL3	144	RO7R	147	RO46R	147	RU23R	148
REN1	145	RO8	146	RO47	146	RU24R	148
REN1R	145	RO8R	146	RO47R	146	RU25	148
REN2	145	RO9	146	RO48R	147	RU25R	148
REN2R	145	RO9R	146	RO49	147	RU26	148
REN3R	145	RO13	147	RO50	147	RU27	148
REN4R	145	RO14	147	RO51	147	RU28	148
REN5R	145	RO15	147	RO53R	147	RUS1	104
RG1	144	RO15R	147	RO67	147	RUS1R	104
RGA1	146	RO20	147	RO67R	147	RUS2	104
RGM1	146	RO20R	147	RO68	147	RUS3R	59
RGM1R	146	RO21	147	RO68R	147	RUS4	148
RIC1	146	RO21R	147	RO69	147	RUS5	148
RIQ1	89	RO22	146	RO77	147	RUS6	148
RIQ1R	89	RO22R	146	RSS3	148-220	RV1	146
RIQ2	89	RO23	146	RU1	148	RW7R	148
RIQ3	89	RO23R	146	RU1R	148	RW8R	148
RIQ4	90	RO24	146	RU2	148	RW25	148
RIQ4R	90	RO24R	146	RU2R	148	RX1	145
RIQ5	90	RO25	146	RU3	148	RX2	145
RIQ5R	90	RO25R	146	RU3R	148	RZA1	146
RIQ6S	89	RO26	146	RU4R	148	RZA2	146
RIQ7	89	RO27	146	RU5	148	RZA3	146
RIQ7R	89	RO27R	146	RU5R	148		
RIQ8	89	RO30	147	RU6	148	S	
RIQ8R	89	RO30R	147	RU7	148	SA1	149
RIQ9	90	RO34	147	RU8R	148	SA1R	149
RIQ9R	90	RO34R	147	RU9R	148	SA2	149
RIQ10R	89	RO37	146	RU10R	148	SA2R	149
RIQ11	90	RO37R	146	RU11R	148	SA3	149

Ref.	Page	Ref.	Page	Ref.	Page	Ref.	Page
SA3R	149	SCH1R	149-220	SH5	152	SLC2TP	140-155
SA4	149	SCM1R	153-220	SH5R	151	SLC3T	155
SA5	149	SCM2	153-220	SH6	152	SLR1	158
SA5R	149	SCM3RP	153-220	SH7	152	SM1	34-86-155
SAM1	160	SCU1	153	SH8	151	SM1R	86-155
SAM1R	160	SD1	154	SH9	151	SM2	155
SAM2	160	SD2	154	SH10	152	SM3	155
SAM2R	160	SD3T	154	SH11	151	SM4	155
SAM3R	160	SE1	153	SH12	151	SM5	155
SAM4	160	SE1R	153	SH12R	151	SM6	155
SAM6	160	SE3	153	SH13	151	SM8	155
SAM8	160	SE3R	153	SH14	151	SM9	155
SAM9R	160	SE5	153	SH15	151	SM9R	155
SAM10	160	SE5R	153	SH16	151	SM10R	155
SAM11R	160	SE7	153	SH17	151	SM11	155
SAM12R	160	SE7R	153	SH18	151	SM12	155
SAM13	160	SE8	153	SH19	152	SM13	155
SAM13R	160	SEA4	126-152	SH20	152	SM14R	155
SAM14	160	SEA4R	126-152	SH21	152	SM15	155
SAM15R	160	SEA5	136-152	SH22	152	SM16	155
SAM16R	160	SEA5R	136-152	SH23	152	SMA1	149
SAN1	149	SEA7	136-152	SH24	152	SN1	157
SAN1R	149	SEA8	136-152	SH27	151	SN1R	157
SAR1	150	SEB1	152-220	SHT1	154	SN2	157
SAR2	150	SEB2	152-220	SHW1	154	SN2R	157
SAR3	150	SEB3	152-220	SHW2	154	SN3R	157
SAR3R	150	SEI10	3	SI1	157	SN4R	157
SAR4R	150	SEM1	153	SI1R	157	SN5R	157
SAR8	150	SF1	149	SI2R	157	SNC1	158
SAR17	150	SF2	149	SI3R	157	SNC2	158
SAR17R	150	SFD1R	160	SI4	157	SNC2R	158
SAR21	150	SG1	47-153	SI4R	157	SNC3	158
SAR21R	150	SG808	47-153	SI5R	157	SNW1	149
SAR22R	150	SG808R	47-153	SI6R	157	SNW2	149
SAR1031	243	SGM1	154	SIA1R	154	SNW3	149
SAR1032	243	SH1	151	SIL1R	154	SO4	159
SB1	149	SH2	151	SJ1R	156	SO5	159
SC1	152	SH3	151	SL1	153	SO6	159
SC2	152	SH4	152	SLC1TP	140-155	SO7	159

Ref.	Page	Ref.	Page	Ref.	Page	Ref.	Page
SO8R	159	SS3R	155	STA11R	161	SV7	163
SO9	159	SS4	156	STF1	162	SV8	163
SO10R	159	SS6	156	STF1R	162	SV8R	163
SO11R	159	SS7	156	STL1R	161	SVE1R	151
SOF1	157	SS7R	156	STL2R	161	SVE2R	151
SOF1R	157	SS8	156	STL3	161	SVN1	155
SOP1	158	SS9	156	STN1	162	SVN2	155
SOP2	158	SS10	155	STN1R	162	SW3	164
SOP10	158	SS12	156	STR3	162	SWA1	154
SOP11	158	SS13	156	STR4	162	SWA2R	154
SOP12	158	SS14	156	STR4R	162	SWA3R	154
SOP13R	158	SS14R	156	STR5	162	SWA4R	154
SOP14RP	158	SSO1	156	STR5R	162	SWA5R	154
SOP15R	158	SSO2	156	STR6	162	SWA6R	154
SOP16R	158	SSP1	156	STS1	162	SWA7R	154
SOP17R	158	SSP1R	156	STS1R	162	SWA8	154
SOP18R	158	SSP2	156	STS2	162	SWA10	154
SPR1	159-220	SSP4	156	STS2R	162	SWL1	162
SPR2	159-220	SSP4R	156	STS3	162	SY1	157
SPU1R	163	SSP5	156	STS4	162		
SQ1	159	SSP6	156	STS5	162-221	T	
SQ2	159	ST1	152	STS6	162-221	TAR1	164
SQ3R	159	STA1	161	STS9	162-221	TAR1R	164
SQ4R	159	STA1R	161	STS11	162	TAR2	164
SQ5	159	STA2	161	STU1	151	TAR21	164-221
SR2	163	STA2R	161	STU3	151	TAR2R	164
SR2R	163	STA3	161	STU6R	151-220	TAR3	164
SR4	163	STA3R	161	STY1P	161	TAR3R	164
SR6	163	STA4	161	SU1R	163	TAR4	164
SR7	163	STA4R	161	SV1	163	TAR4R	164
SR8	163	STA5	161	SV1R	163	TAR5	164
SR9R	163	STA6	161	SV2	163	TAR5R	164
SR10R	163	STA6R	161	SV2R	163	TAR8	164
SR11R	163	STA7	161	SV3	163	TAR16	164-221
SRT1	150	STA8	161	SV3R	163	TAR16R	164-221
SRT2	150	STA8R	161	SV4	163	TC1	166
SS1	155	STA9R	161	SV4R	163	TC1R	166
SS1R	155	STA10	161	SV5R	163	TCL1	165
SS3	155	STA10R	161	SV6R	163	TE1	165

Ref.	Page	Ref.	Page	Ref.	Page	Ref.	Page
TE1R	165	TL6	172	TN23	167	TO8X4	169
TE2	165	TL6R	172	TN31R	167	TO8X5	169
TE2R	165	TL7	172	TN32	168-222	TO8X6	169
TE2X	166	TL7R	172	TN35	167	TO8X7	169
TE3	165	TL8	172	TN36	167	TO8X8	169
TE4	166-221	TL8R	172	TN36R	167	TO8X9	169
TE4R	166-221	TL9	173	TN37R	167	TO8X10	169
TE5	166-221	TL9R	173	TN39	167	TO8X11	169
TE6	165	TL10	173	TN42	167	TO8X12	169
TE7	166-221	TL10R	173	TN42R	167	TO8X13	169
TE8XFA	166	TL11	173	TO1	170	TO8X14	169
TE9	166-221	TL11R	173	TO1X	170	TO8X15	169
TE16	166-221	TL12	173	TO2	170	TO8X16	169
TE19	166-221	TL12R	173	TO3	170	TO8X17	169
TEC1	165-221	TL13	173	TO4	170	TO8X18	169
TFN1	166	TL14	173	TO5	170	TO9RY1	169
TFN2	166	TL15	173	TO6	170	TO9RY2	169
TG1	167	TL15R	173	TO7	170	TO9RY3	169
TGS1R	165-221	TLN1	164	TO8RX1	169	TO9RY4	169
THA1	166	TN1	167	TO8RX2	169	TO9RY5	169
THR1	166-221	TN1R	167	TO8RX3	169	TO9RY6	169
TI1	167	TN2	167	TO8RX4	169	TO9RY7	169
TK1	165	TN2R	167	TO8RX5	169	TO9RY8	169
TK1R	165	TN4	167	TO8RX6	169	TO9RY9	169
TK2	165	TN4R	167	TO8RX7	169	TO9RY10	169
TK2R	165	TN5	167	TO8RX8	169	TO9RY11	169
TK3R	165	TN6R	168	TO8RX9	169	TO9RY12	169
TK4	165	TN7	167	TO8RX10	169	TO9RY13	169
TK4R	165	TN8R	167	TO8RX11	169	TO9RY14	169
TL1	172	TN9	168	TO8RX12	169	TO9RY15	169
TL1R	172	TN10	168	TO8RX13	169	TO9RY16	169
TL2	172	TN11R	168	TO8RX14	169	TO9RY17	169
TL2R	172	TN14	168	TO8RX15	169	TO9RY18	169
TL3	172	TN16	167	TO8RX16	169	TO9Y1	169
TL3R	172	TN16X	167	TO8RX17	169	TO9Y2	169
TL4	172	TN16XA	167	TO8RX18	169	TO9Y3	169
TL4R	172	TN19R	167	TO8X1	169	TO9Y4	169
TL5	172	TN20	167	TO8X2	169	TO9Y5	169
TL5R	172	TN20R	167	TO8X3	169	TO9Y6	169

Ref.	Page	Ref.	Page	Ref.	Page	Ref.	Page
TO9Y7	169	TO35	170	TO51Y7	169	TO92R	168
TO9Y8	169	TO36R	170	TO51Y8	169	TO100	171
TO9Y9	169	TO39R	170	TO51Y9	169	TO104	171
TO9Y10	169	TO40	170	TO51Y10	169	TO105	171
TO9Y11	169	TO41R	170	TO51Y11	169	TO106	171
TO9Y12	169	TO42R	170	TO51Y14	169	TO107	171
TO9Y13	169	TO43	171	TO52	171	TO108X	170
TO9Y14	169	TO44	168	TO53	171	TO111R	171
TO9Y15	169	TO45	171	TO54-1	170	TO114RX	170
TO9Y16	169	TO50RX2	169	TO54-2	170	TO120RX	170
TO9Y17	169	TO50RX4	169	TO54-3	170	TO124RX	170
TO9Y18	169	TO50RX5	169	TO54-4	170	TO125X	170
TO10	170	TO50RX6	169	TO54-5	170	TO127	171
TO11	171	TO50RX7	169	TO54-6	170	TOL1	174
TO12	168	TO50RX9	169	TO54-7	170	TOL2	174
TO13	171	TO50X1	169	TO54-8	170	TOP1R	6-171
TO14	171	TO50X2	169	TO54-13	170	TOP1RX	171
TO15	170	TO50X3	169	TO54-14	170	TOU1R	171
TO16	170	TO50X4	169	TO54-16	170	TOU2R	171
TO17	170	TO50X5	169	TO54-17	170	TOU3R	171
TO18	171	TO50X6	169	TO54-18	170	TOZ2	168
TO19	171	TO50X7	169	TO54-19	170	TP1	28-164
TO20R	171	TO50X8	169	TO54-20	170	TP1R	164
TO21	171	TO50X9	169	TO54-21	170	TP2	164
TO22	168	TO50X10	169	TO54-23	170	TP2R	164
TO23	168	TO50X11	169	TO54-24	170	TP3	164
TO24	168	TO50X13	169	TO55	171	TP3R	164
TO25R	170	TO50X14	169	TO57	171	TR1	173
TO26	168	TO50X15	169	TO58	171	TR2	173
TO27	171	TO50X17	169	TO59	171	TR3	173
TO28R	170	TO50X18	169	TO60	171	TR4	173
TO29	168	TO51RY1	169	TO61	171	TR5	173
TO30	170	TO51RY4	169	TO64	171	TR8	173
TO30R	170	TO51RY6	169	TO65	171	TR9	173
TO30RX	170	TO51Y1	169	TO66	168	TR10	173
TO30X	170	TO51Y2	169	TO75R	170	TR10R	173
TO31R	170	TO51Y3	169	TO81R	170	TR11R	173
TO33	171	TO51Y5	169	TO82R	170	TR12	173
TO34	170	TO51Y6	169	TO91	171	TR13R	173

Ref.	Page	Ref.	Page	Ref.	Page	Ref.	Page
UNI28	176	UP1	180	VAC22	182	VAC53	184
UNI29	177	UR1	180	VAC22N	182	VAC54	184
UNI30	177	UR1R	180	VAC22R	183	VAC55	184
UNI31	176	UR2	180	VAC22RN	183	VAC56	182
UNI31R	176	UR2R	180	VAC23	182	VAC57	182
UNI32	176	V		VAC23R	183	VAC58	182
UNI32R	176		VAC1	180	VAC25	181	VAC60
UNI33	176	VAC1R	180	VAC25R	181	VAC60R	181
UNI33R	176	VAC2	182	VAC29	181	VAC61	181
UNI34	176	VAC3	182	VAC30	182	VAC63	182
UNI34R	176	VAC4	182	VAC30R	182	VAC65	181
UNI35	176	VAC5	182	VAC31	183	VAC65R	181
UNI35R	176	VAC6	182	VAC31R	182	VAC66	181
UNI36	176	VAC8	180	VAC32	183	VAC66R	181
UNI36R	176	VAC8R	180	VAC33	181	VAC68	184
UNI37	176	VAC10	181	VAC33R	181	VAC69	184
UNI38	176	VAC11	181	VAC34	183	VAC70	184
UNI39	176	VAC14	181	VAC34R	182	VAC71	184
UNI39R	176	VAC15	182	VAC36	182	VAC72	184
UNI41R	176	VAC15R	183	VAC36R	183	VAC73	184
UNI44	176	VAC16	182	VAC37	182	VAC74	184
UNI45	176	VAC16R	183	VAC37R	183	VAC75	184
UNI45R	176	VAC17	182	VAC38	182	VAC76	184
UNI46	176	VAC17R	183	VAC38R	183	VAC77	184
UNI47	176	VAC18	182	VAC39	184	VAC78	184
UNI50	176	VAC18R	183	VAC40	182	VAC79	184
UNI51	176	VAC19	182	VAC40R	183	VAC80	184
UNI51R	176	VAC19N	182	VAC41	181	VAC81	184
UNI54R	176	VAC19R	183	VAC42	181	VAC82	184
UNI57R	177	VAC19RN	183	VAC42R	181	VAC83	184
UNI59R	177	VAC20	182	VAC44R	181	VAC84	184
UNI60R	177	VAC20N	182	VAC45	184	VAC85	184
UNI61	177	VAC20R	183	VAC46	180	VAC86	184
UNI61R	177	VAC20RN	183	VAC47	182	VAC87	184
UNI63	177	VAC21	182	VAC48	184	VAC88	184
UNI66R	176	VAC21N	182	VAC49	184	VAC89	184
UNI67R	176	VAC21R	183	VAC50	184	VAC91	184-222
UNI68R	176	VAC21RN	183	VAC51	184	VAC100	181
UNI1010	243			VAC52	184	VAC100R	181

Ref.	Page	Ref.	Page	Ref.	Page	Ref.	Page
VAC101	183	VAC138	183	VI087	187	VL3R	186
VAC103	184-222	VAC139	183	VI088	187	VL4	186
VAC104	184-222	VAC140	183	VI089	187	VL4R	186
VAC105	184-222	VAC141	183	VI1	187	VL5E	102-186
VAC106	181	VAC142	183	VI1R	187	VL5RE	102-186
VAC106R	181	VAC143	183	VI2	187	VLG1	188
VAC107	181	VAC144	183	VI2R	187	VLK1R	188
VAC107R	181	VAC145	183	VI3	187	VLK2R	188
VAC108	183	VAC146	183	VI3R	187	VN1	186
VAC109	183	VAC147	183	VI4	187	VOG1	188
VAC110	183	VAC148	183	VI4R	187	VR1	185
VAC111	183	VAC150	184-222	VI5	187	VS090V	188
VAC112	183	VAC151	184	VI5R	187	VSR1R	185
VAC113	183	VAL1	185	VI6	187	VSR2	185
VAC114	183	VAL2	185	VI7	187	VSR2R	185
VAC115	183	VAR1	185	VI7R	187	VYA	197
VAC116	183	VAR1R	185	VI8	187	VYA6	196
VAC117	183	VAR2	185	VI8R	187	VYB	197
VAC118	183	VAR2R	185	VI9	187	VYB6	196
VAC119	183	VAR3	185	VI9R	187	VYC	197
VAC11R	181	VAR3R	185	VI10	187	VYC6	196
VAC120	183	VAR4	185	VI10R	187	VYD	197
VAC121	183	VAR4R	185	VI11	187	VYD6	196
VAC122	183	VAR5	185	VI12	187	VYE	197
VAC123	183	VBH1R	185-223	VI13	187	VYE6	196
VAC124	183	VC1	185	VI14	187	VYF	197
VAC125	183	VC1R	185	VI15R	186	VYF6	196
VAC126	183	VEG1	185	VI16R	186	VYG	197
VAC127	183	VG1	186	VI17	187	VYG6	196
VAC128	183	VG2	186	VI18R	186	VYH	197
VAC129	183	VG3	186	VI19	186-223	VYH6	196
VAC130	183	VGD1	185-223	VI23	187	VYK	197
VAC131	183	VI080	187	VK1	188	VYK6	196
VAC132	183	VI081	187	VK2	188	VYP6A	196
VAC133	183	VI082	187	VL1	186	VYP6B	196
VAC134	183	VI083	187	VL2	186	VYP6D	196
VAC135	183	VI084	187	VL2R	186		
VAC136	183	VI085	187	VL2RE	102		
VAC137	183	VI086	187	VL3	186		

Ref.	Page	Ref.	Page	Ref.	Page	Ref.	Page
W		WEB5	189	WK25	192	WK70	192-223
WA1	188	WEI1	189	WK25R	192	WK71X	192
WA1R	188	WEI2	189	WK26	191	WLC1	192
WA2	188	WEI3	189	WK27	191	WMS1	192
WA2R	188	WEI4	189	WK28	191	WMS2	192
WA3	188	WEI5	189	WK29	191	WR1	192
WA3R	188	WEI8	189	WK30	191	WR2	192
WA4	188	WEI9	189	WK31	191	WR3	192
WA4R	188	WFE1	190	WK32	191	WR4	192
WA6	188	WFE1R	190	WK33	191	WR5R	192
WA6R	188	WGU1	188	WK34	191	WS1	190
WA7	188	WH1	192	WK35	191	WS2	190
WA7R	188	WJ1R	188-223	WK36	191	WSA1	189
WA8	188	WK1	191	WK37	191	WSA2R	189
WC1	191	WK1X	191	WK38	191	WSD1	193
WC2	191	WK2	192	WK39	191	WSD1R	193
WC3	191	WK2R	192	WK40	191	WST1	190
WE1	189	WK3	84-191	WK41R	192	WST2	190
WE1R	189	WK4	192	WK42R	192	WST3	190
WE2	190	WK5	191	WK43R	192	WST4	190
WE2R	190	WK6	192	WK44R	192	WST5	190
WE3	190	WK6R	192	WK45R	192	WTR1R	189
WE3R	190	WK7	191	WK45X	192	WU1R	189-223
WE4	190	WK8	191	WK46	191		
WE4R	190	WK8R	191	WK47R	192	X	
WE5	189	WK9	192	WK48	191	XAA1	227
WE5R	189	WK10	192	WK49R	191	XAA2	227
WE7	189	WK11	192	WK50R	191	XAG2	227
WE7R	189	WK12	192	WK51R	191	XB1	227
WE8	190	WK13	192	WK52R	192	XB2	227
WE12	190	WK14	192	WK53R	192	XB3	227
WE14	189	WK15	192	WK54R	192	XBD1	229
WE15	190	WK16	191	WK55	191	XBD2	229
WE16	189	WK17R	192	WK56R	192	XBD3	229
WE16R	189	WK18	191	WK59R	191	XBD4	229
WEB1	189	WK19	191	WK60R	191	XBD5	229
WEB2	189	WK20	191	WK63R	191	XBD6	229
WEB3	189	WK21	191	WK68R	191	XBD7	229
WEB4	189	WK22	191	WK69	191		

Ref.	Page
XBRA1P	227
XBRY1	227
XBRY2	227
XBW1	228
XBW1P	228
XBW2	228
XBW2P	228
XBW3	228
XBW3P	228
XBW4	228
XBW4P	228
XBW5	229
XBW5P	229
XC1	230
XCCF10	230
XCCF2	229
XCCF3	229
XCCF6	230
XCCF7	230
XCCF8	230
XCCF9	230
XF1P	231
XF2	231
XF2P	231
XFB1	230
XFB1P	230
XFP1	231
XG1P	231
XGR1	231
XH1	232
XH2	232
XH3	232
XIE3	232
XIE4	232
XKV2	233
XKV6	233
XKV7	233
XKV8	233
XKV10	233

Ref.	Page
XKV11	233
XM1	234
XM2	234
XMBL2P	234
XMR1	234
XMR2P	234
XN1	235
XN1P	235
XN3	235
XNA1	234
XOC1	235
XPDO1P	235
XPK1	236
XPK2	236
XPZ1	235
XPZ1P	235
XPZ2	235
XPZ2P	235
XSAM3	236
XSLH1P	236
XSLH2P	236
XTF1	236
XTF2	236
XTF3	236
XY1	237
XY1P	237
XY2	237
XY2P	237
XY3P	237
XY4	237
XY4P	237
XY5P	237
XY6P	238
XY7	238
XY10P	238
XYAT11	238
XZ1A	239
XZ1AP	239
XZ1BP	239

Ref.	Page
XZ1CP	239
XZ2A	239
XZ2AP	239
XZ2B	239
XZ2BP	239
XZ2CP	239
XZ3A	240
XZ3AP	240
XZ3BP	240
XZ3CP	240
XZ5A	239
XZ6AP	240
XZAS1	238
XZAS2	238
XZAS3	238
Y	
YA1	144-193
YA1E	193
YA1ER	193
YA1R	144-193
YA2	196
YA2R	196
YA3	194
YA3R	194
YA4	194
YA4R	194
YA5	193
YA5R	193
YA6	195
YA6R	195
YA7	195
YA7R	195
YA8	194
YA8E	194
YA8ER	194
YA8R	194
YA9	30-193

Ref.	Page
YA13	195
YA13R	195
YA14	195
YA14R	195
YA15	194
YA15R	194
YA16	194
YA16L	194
YA16R	194
YA16RL	194
YA17	194
YA17R	194
YA18	45-194
YA18R	194
YA19	194
YA19R	194
YA20	194
YA20R	194
YA21	194
YA22	194
YA23	194
YA24	194
YA25	194
YA26	194
YA27R	193
YA29	193
YA29R	193
YA30	194
YA30R	194
YA31	195
YA31R	195
YA32	194
YA32R	194
YA33	195
YA34	193
YA35	193
YA36	193
YA39	196
YA39P	196

Ref.	Page	Ref.	Page	Ref.	Page	Ref.	Page
YA40P	196	YA72	197	YT3	198	YYD6	197
YA41	195	YA72R	197	YT3R	198	YYE	197
YA42	195	YA73P	196	YT4	199	YYE6	197
YA43	195	YA74	196	YT4R	199	YYF	197
YA44	195	YA74R	196	YT5	199	YYF6	197
YA45	195	YA84	193	YT5R	199	YYG	197
YA46	195	YA84R	193	YT6	198	YYG6	197
YA47	195	YA85R	193	YT6R	198	YYH	197
YA48	195	YA86	193	YT7	198	YYH6	197
YA49	195	YA86R	193	YT7R	198	YYK	197
YA50	195	YA87	195	YT8	198	YYK6	197
YA51	195	YA88	194	YT8R	198	YYP6A	197
YA52	195	YA89	194	YT9	199	YYP6B	197
YA53	195	YA90	195-223	YT9R	199	YYP6D	197
YA54	195	YA91	194	YT10	199		
YA55	195	YA93	195	YT10R	199	Z	
YA56	195	YA94	195-223	YT11	199	ZA2R	200
YA57	195	YA95R	195-223	YT11R	199	ZD4	199
YA58	195	YA226	195	YT12	198	ZD4R	199
YA59	195	YA227	195	YT12R	198	ZD5	199
YA60	195	YA1007	244	YT13	198	ZD5R	199
YA61	195	YAR1	198	YT13R	198	ZD6	199
YA62	195	YD1	198	YT14	198	ZD7	34-199
YA63	195	YD1R	198	YT14R	198	ZD8	199
YA64	193	YD2	198	YT15	114	ZD9	34-199
YA64R	193	YD2R	198	YT15R	114	ZD9P	34-199
YA65	194	YD3R	198	YT15RX	114	ZD10P	187
YA65R	194	YD4	198	YT15X	114	ZD11	34-199
YA66	194	YD4R	198	YT16	114	ZD11P	34-199
YA66R	194	YD5R	198	YT16X	114	ZD14RP	199
YA67	193	YD6R	198-223	YUH1R	199	ZD25	200-224
YA68	194	YD7R	198-223	YUH2R	199	ZD26R	200
YA68R	194	YD12	198	YYA	197	ZE1	200
YA69	194	YD13R	198-223	YYA6	197	ZE1R	200
YA69R	194	YD14R	198-223	YYB	197	ZE1RX	200
YA70	197	YT1	198	YYB6	197	ZE1X	200
YA70R	197	YT1R	198	YYC	197	ZE2	201
YA71	197	YT2	199	YYC6	197	ZE3	201
YA71R	197	YT2R	199	YYD	197	ZE3R	201



Ref.	Page	Ref.	Page	Ref.	Page	Ref.	Page
ZE4	201						
ZE5	201						
ZE5R	201						
ZE7	201						
ZE10	200						
ZE10R	200						
ZE11	200						
ZE11R	200						
ZE12	201						
ZE13	200						
ZE13R	200						
ZE14	200						
ZE14R	200						
ZE15	200						
ZE16	200						
ZE30	201						
ZE30R	201						
ZE34	200						
ZE34R	200						
ZE34RX	200						
ZE34X	200						
ZE39	200						
ZE39RX	200						
ZE39X	200						
ZE40X	200						
ZE42	200						
ZE45	200						
ZH1R	202-224						
ZI1	200						
ZI1R	200						
ZI2R	200						
ZI3R	200						
ZI4	200						
ZI4R	200						
ZI5	200						
ZI5R	200						
ZN1	201						



Dimple Keys Index
Indice chiavi punzonate
Bohrmuldenschlüssel Index
Index clés à points
Indice llaves de seguridad
Índice chaves de pontos

Ref.	Page	Ref.	Page	Ref.	Page	Ref.	Page
A		BUR27	207	DK7	209	EL9	210
AB40	205	BUR33	207	DLC1	209	EU17	211
AB48	205	BUT1R	207	DLC1R	209	EZ3	211
AB62	205	BZ3	219	DLC2R	209	EZ3X	211
AB74	205	C		DLC3	209	EZ4	211
AB77	205	CB87	208	DM21	210	EZ4X	211
AB84	205	CB97	208	DM22	210	EZ5	211
AGA7	205	CB98	208	DM22TV1	210	EZ5X	211
AGA9	205	CE131	207	DM22TV10	210	EZ6	211
AGB5	205	CIS12	207	DM22TV2	210	EZ6X	211
AGB6	205	CIS9	207	DM22TV3	210	F	
AGB7	205	CIS12	207	DM22TV4	210	FAC15	211
AGB8	205	CIS9	207	DM22TV5	210	FAC31	211
AGB9	205	CRL1	207	DM22TV5	210	FH12	212
AGN1	206	CS48	207	DM22TV6	210	FH17R	212
AHR2	206	CS62	208	DM22TV7	210	FH32	212
ALP16	206	CS62P	208	DM22TV8	210	FH33	212
AMG1R	206	CS70	208	DM22TV9	210	FH34R	212
APK2R	206	CS70P	208	DM22TVP	210	FH35	212
APK3R	206	CS115	208	DM22TVP	210	FH36	212
AZ6	206	CS116P	208	DM24	209	FH37R	212
AZ6R	206	CS139	208	DM49	209	FI3R	212
AZ7	206	CS139P	208	DM53	209	FI4R	212
AZ8	206	CS140	208	DM55	210	FV4	212
B		CS141	208	DM58	210	FVR1	211
BAE1	206	CS144	208	DM64	209	FVR2R	211
BD11	207	CS145	208	DM118	209	FVR3	211
BD11X	207	CS146	208	DM120	209	FVR4R	211
BD13	207	CVL5R	208	DM122	209	FY1R	212
BD14	207	CYS2	207	DM128	210	G	
BD14X	207	D		DM138	210	GE57	213
BD16	207	DF4R	208	DM139	210	GF1	213
BD21	207	DFE1RP	208	DM144	210	GO6	213
BD22	207	DFE2P	208	DM145	210	GO7	213
BEY1R	206	DFE3RAP	209	DS6	210	GPI1	213
BEY2R	206	DIR1R	209	DS7	210	GS17	213
BNK1	206	DK1	209	E		GVY1R	213
		DK3	209	EC5	210-221		
		DK6	209				

Ref.	Page	Ref.	Page	Ref.	Page	Ref.	Page
H		KLE10R	215	L		S	
HGO1R	213			MTK4RP	218	SCH1R	220
HOK1R	213	LC14R	216	MTK4RPX	218	SCM1R	220
I		LCK1R	216	MTK7RP	218	SCM2	220
IE14	213	LCK1RX	216	MTK8RP	218	SCM3RP	220
IE15	213	LEA1	216	MTK9RP	218	SEB1	220
IE26	214	LH13P	216	MTK10RP	218	SEB2	220
IE26P	214	LH14P	216	MTK11R	218	SEB3	220
IE30	214	LH15P	216	MTK12R	218	SPR1	220
IF14	213	LH16P	216	MTK12RP	218	SPR2	220
IO1	214	LH17P	216	MTK13R	218	STS5	221
IR1	213	LH18P	216	MTK13RA	218	STS6	221
K		LH41P	216	MTK14RP	218	STS9	221
KA1	214	LP11	215-216	MTK15R	218	STU6R	220
KA2	214	M		MTK15RA	218	T	
KA3	214	MC9X	217	MTK16	218	TAR16	221
KA4	214	MC10R	217	MTL1	217	TAR16R	221
KA5	214	MC14R	217	O		TAR21	221
KA6	214	MC15R	217	OC3	219	TE16	221
KA7	214	MEG1R	217	OC4	219	TE19	221
KA8	214	MEG2	217	OC6	219	TE4	221
KA9	214	MER38	217	OJ14	218	TE4R	221
KAK1	214	MER39	217	OJ18	218	TE5	221
KE1	215	MG8	217	P		TE7	221
KE2	215	MG9	217	PF18	219	TE9	221
KE3	215	MGN1RP	216	PF20	219	TEC1	221
KE4	215	MLM5	217	PIC1	219	TGS1R	221
KE9	215	MS20P	216	PIC2	219	THR1	221
KE11	215	MS22	216	PN1	219	TN32	222
KE13	215	MS23	216	PN2	219	TRM1R	205
KLE1	215	MSL1	216	PT4R	219	TV1	222
KLE2R	215	MTA2	217	PT5RP	219	TV2	222
KLE4	215	MTA4	217	R		TV3	222
KLE8R	215	MTK1	218	RSS3	220	TV4	222
KLE9R	215	MTK2P	218				
		MTK3P	218				
		MTK4P	218				

Ref.	Page	Ref.	Page	Ref.	Page	Ref.	Page
U							
UB3	222						
UC3RP	222						
UC4R	222						
UC5R	222						
UC8R	222						
V							
VAC91	222						
VAC103	222						
VAC104	222						
VAC105	222						
VAC150	222						
VBH1R	223						
VGD1	223						
VI19	223						
W							
WJ1R	223						
WK70	223						
WU1R	223						
Y							
YA90	223						
YA94	223						
YA95R	223						
YD13R	223						
YD14R	223						
YD6R	223						
YD7R	223						
Z							
ZD25	224						
ZH1R	224						



Cruciform Keys Index
Indice chiavi a croce
Kreuzschlüssel Index
Index clés cruciformes
Indice llaves en cruz
Índice chaves tetra



Ref.	Page	Ref.	Page	Ref.	Page	Ref.	Page
X		XF2P	231	XTF3	236		
XAA1	227	XFB1	230	XY1	237		
XAA2	227	XFB1P	230	XY1P	237		
XAG2	227	XFP1	231	XY2	237		
XB1	227	XG1P	231	XY2P	237		
XB2	227	XGR1	231	XY3P	237		
XB3	227	XH1	232	XY4	237		
XBD1	229	XH2	232	XY4P	237		
XBD2	229	XH3	232	XY5P	237		
XBD3	229	XIE3	232	XY6P	238		
XBD4	229	XIE4	232	XY7	238		
XBD5	229	XKV2	233	XY10P	238		
XBD6	229	XKV6	233	XYAT11	238		
XBD7	229	XKV7	233	XZ1A	239		
XBRA1P	227	XKV8	233	XZ1AP	239		
XBRY1	227	XKV10	233	XZ1BP	239		
XBRY2	227	XKV11	233	XZ1CP	239		
XBW1	228	XM1	234	XZ2A	239		
XBW1P	228	XM2	234	XZ2AP	239		
XBW2	228	XMBL2P	234	XZ2B	239		
XBW2P	228	XMR1	234	XZ2BP	239		
XBW3	228	XMR2P	234	XZ2CP	239		
XBW3P	228	XN1	235	XZ3A	240		
XBW4	228	XN1P	235	XZ3AP	240		
XBW4P	228	XN3	235	XZ3BP	240		
XBW5	229	XNA1	234	XZ3CP	240		
XBW5P	229	XOC1	235	XZ5A	239		
XC1	230	XPDO1P	235	XZ6AP	240		
XCCF2	229	XPK1	236	XZAS1	238		
XCCF3	229	XPK2	236	XZAS2	238		
XCCF6	230	XPZ1	235	XZAS3	238		
XCCF7	230	XPZ1P	235	XZAS1	232		
XCCF8	230	XPZ2	235	XZAS2	232		
XCCF9	230	XPZ2P	235	XZAS3	232		
XCCF10	230	XSAM3	236				
XF1P	231	XSLH1P	236				
XF2	231	XSLH2P	236				
		XTF1	236				
		XTF2	236				



Mail Box and Lift Keys Index
Indice chiavi per casellari e ascensori
Fachkästen-und Liftschlüssel Index
Index clés pour casiers et ascenseurs
Indice llaves para casillas y ascensores
Índice chaves para caixas de correio e elevadores



Ref.	Page	Ref.	Page	Ref.	Page	Ref.	Page
1		AFI1	246	R			
1000	243	AIN1	246	RL1	243		
1001	243	AMA1	247	S			
1002	243	APE1	247	SAR1031	243		
1003P	243	APE1F	247	SAR1032	243		
1003P1	243	APE2	247	U			
1004	244	ARO1	247	UNI1010	243		
1005	244	ASAB1	247	Y			
1008	244	ASAF1	247	YA1007	244		
1009	244	ASI1	247				
1012	244	ASI2	247				
1013	244	AST1	247				
1014	244	C					
1015	244	CRE401	244				
1016	244	CRE402	244				
5		CRE403	244				
5BDE1	245	CRE404	244				
5HRM1	245	CRE405	244				
6		CRE406	244				
6BDE1	245	CS1003	243				
6BDE2	245	CU402	244				
6BDE3	245	CU405	244				
6OG1	245	CU413	244				
6SV1	245	CX7	243				
A		M					
ABA1	246	MBS300	245				
ABO1	246	MBS301	245				
ABO2	246	MIS1	243				
ABO3	246	MIS2	243				
ABO4	246	MU401	245				
ABOS1	246	MU402	245				
AFA1	246	MU403	245				
		MU404	245				